



(19) **United States**  
(12) **Patent Application Publication**  
**Dinan**

(10) **Pub. No.: US 2016/0270061 A1**  
(43) **Pub. Date: Sep. 15, 2016**

(54) **SECONDARY CELL AND CONTROL CHANNEL IN A WIRELESS DEVICE AND WIRELESS NETWORK**

*H04W 76/06* (2006.01)  
*H04W 72/14* (2006.01)

(52) **U.S. Cl.**  
CPC ..... *H04W 72/0413* (2013.01); *H04W 72/14* (2013.01); *H04W 72/0446* (2013.01); *H04L 5/0048* (2013.01); *H04W 76/068* (2013.01)

(71) Applicant: **Ofinno Technologies, LLC**, Herndon, VA (US)

(72) Inventor: **Esmael Hejazi Dinan**, Herndon, VA (US)

(73) Assignee: **Ofinno Technologies, LLC**, Herndon, VA (US)

(57) **ABSTRACT**

(21) Appl. No.: **15/054,420**

(22) Filed: **Feb. 26, 2016**

**Related U.S. Application Data**

(60) Provisional application No. 62/130,504, filed on Mar. 9, 2015.

**Publication Classification**

(51) **Int. Cl.**  
*H04W 72/04* (2006.01)  
*H04L 5/00* (2006.01)

A plurality of physical uplink control channel (PUCCH) groups comprise a primary PUCCH group comprising a primary cell and a secondary PUCCH group comprising a PUCCH secondary cell. The wireless device deactivates the PUCCH secondary cell after a deactivation condition for the PUCCH secondary cell is met. The wireless device stops transmission of channel state information for a first secondary cell in the secondary PUCCH group after deactivation of the PUCCH secondary cell. The wireless device stops transmission of positive acknowledgement and negative acknowledgement on the PUCCH secondary cell after deactivation of the PUCCH secondary cell.

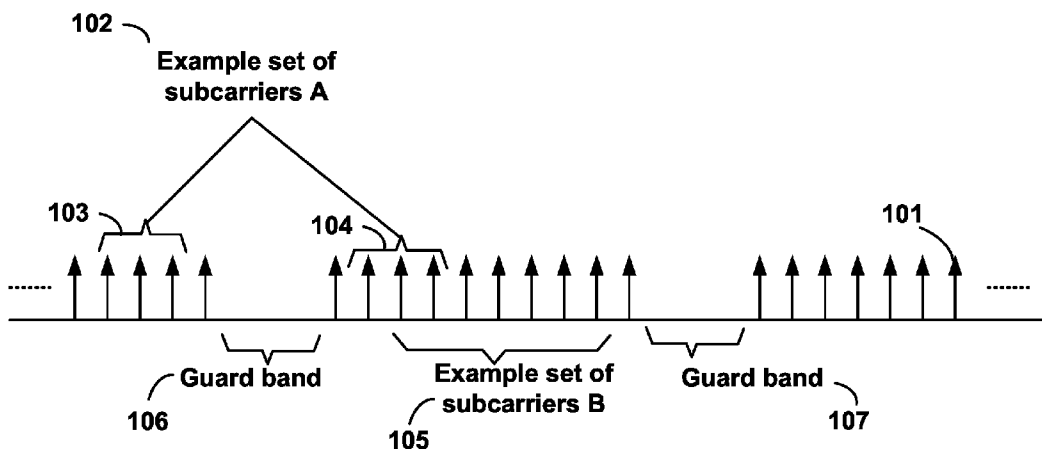

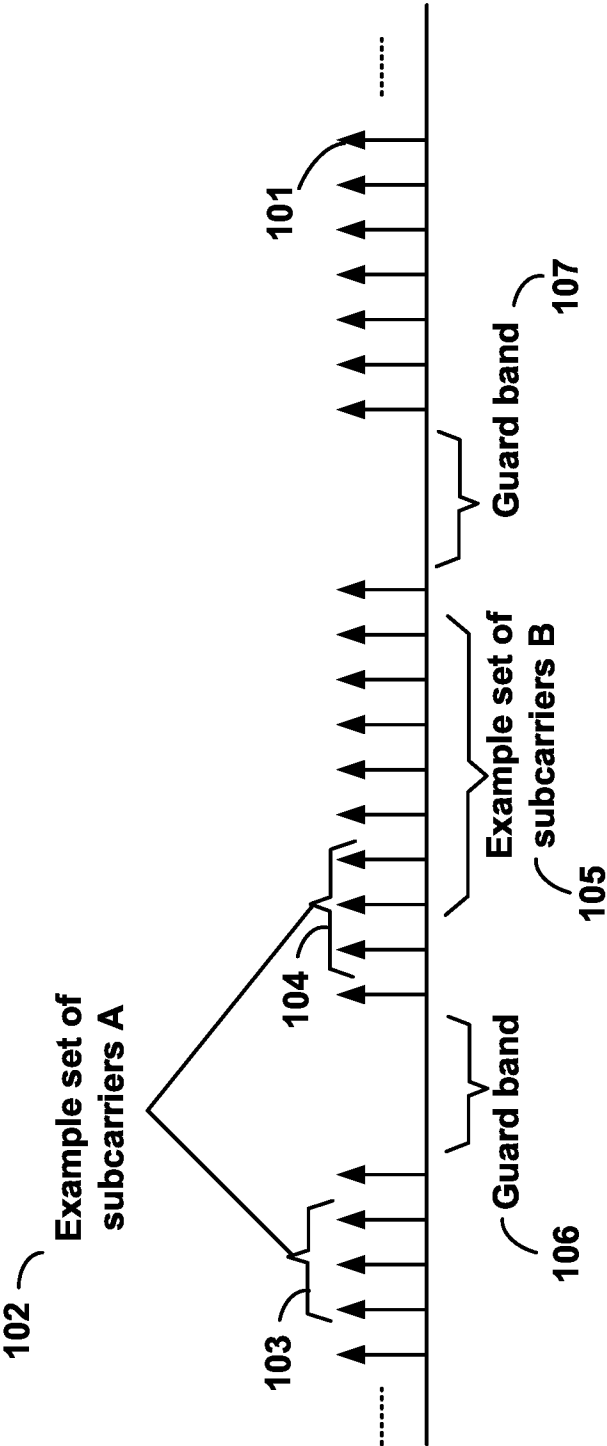

FIG. 1

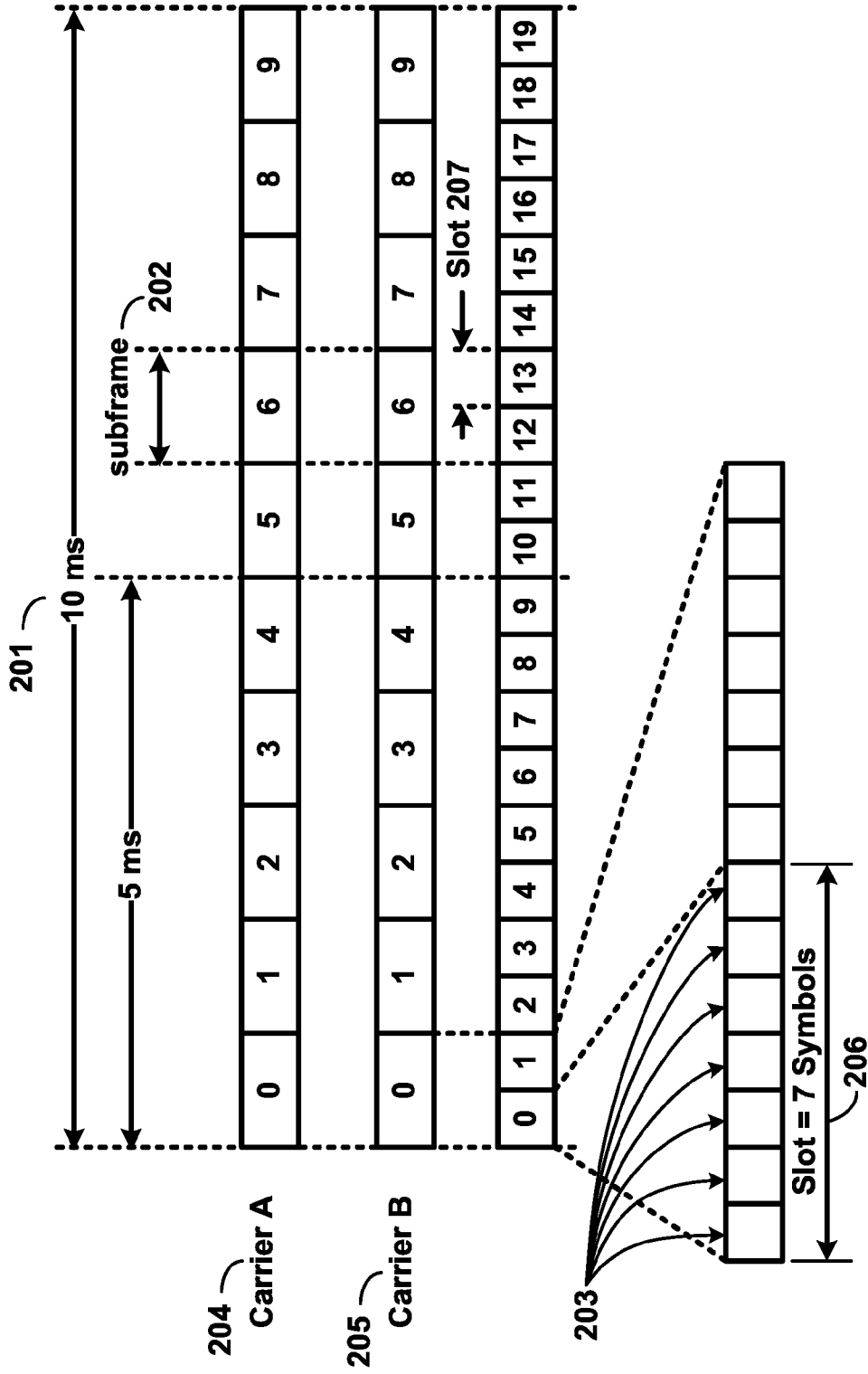

FIG. 2

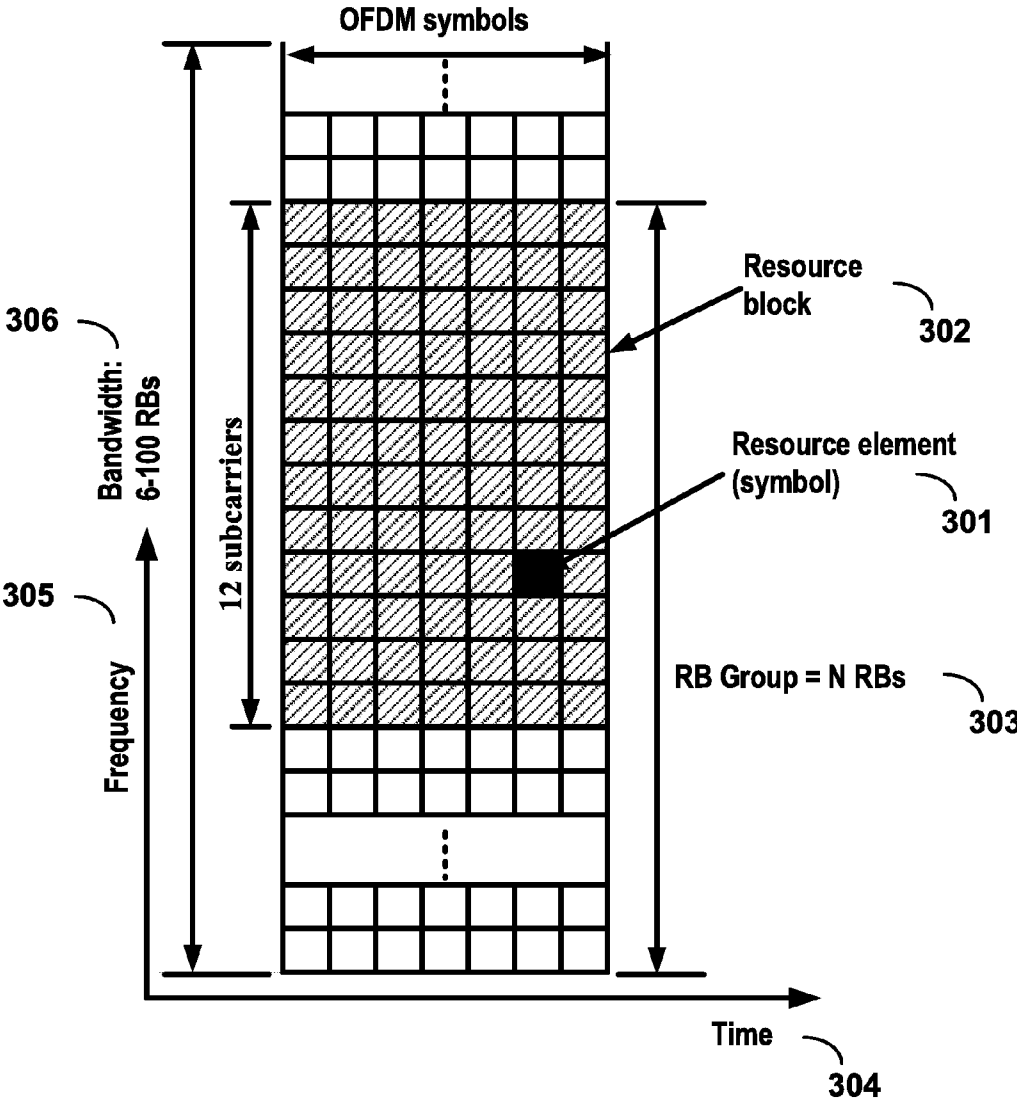

FIG. 3

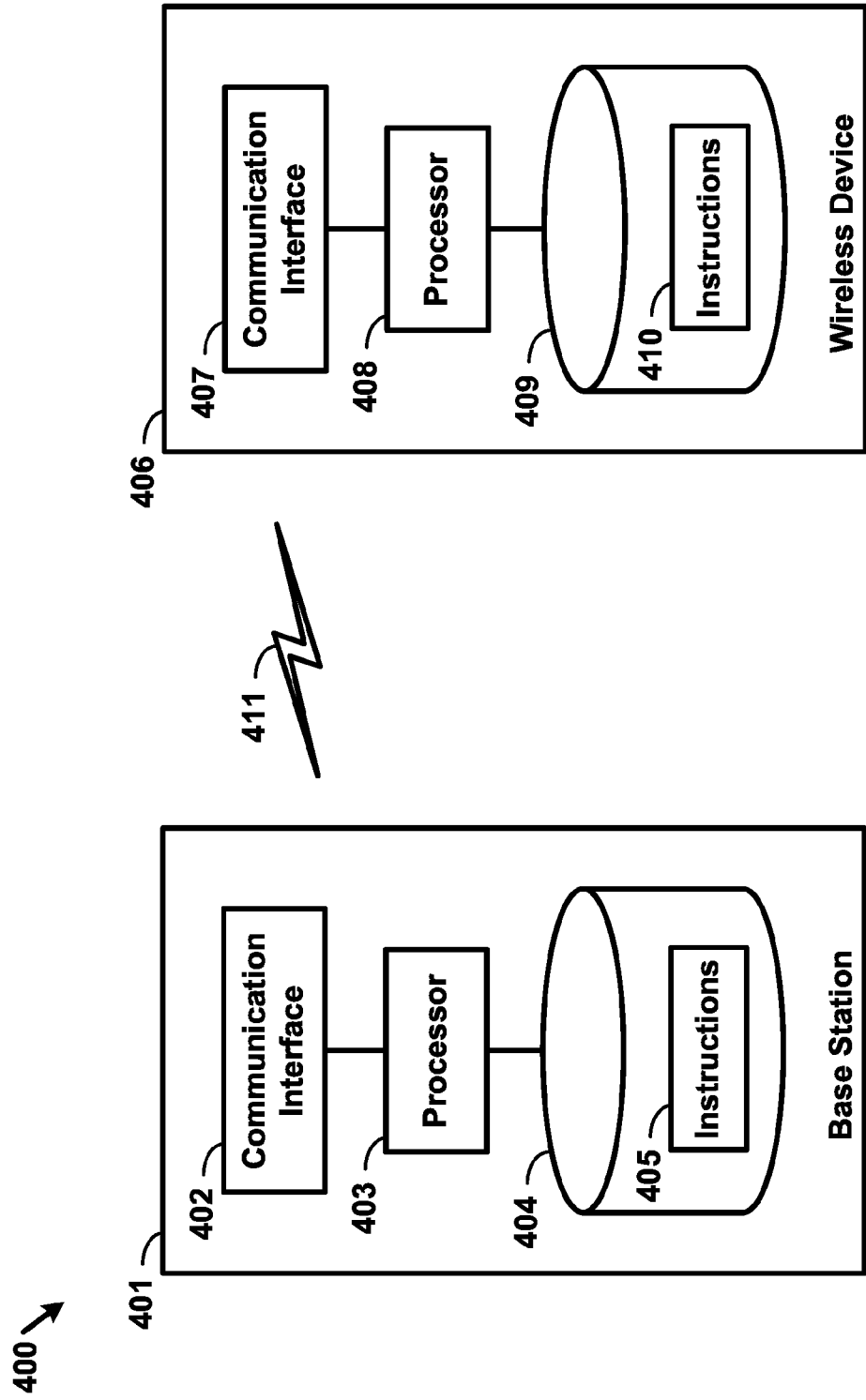

FIG. 4

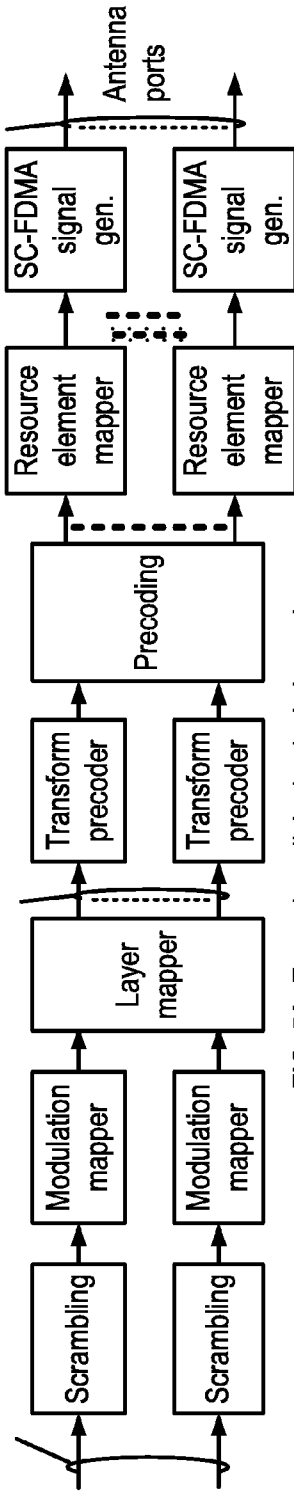

FIG. 5A Example uplink physical channel

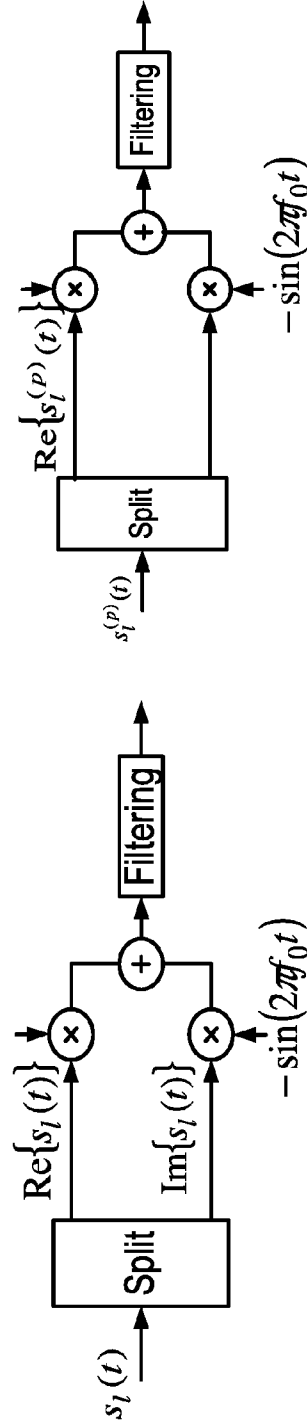

FIG. 5B Example uplink modulation

FIG. 5D Example downlink modulation

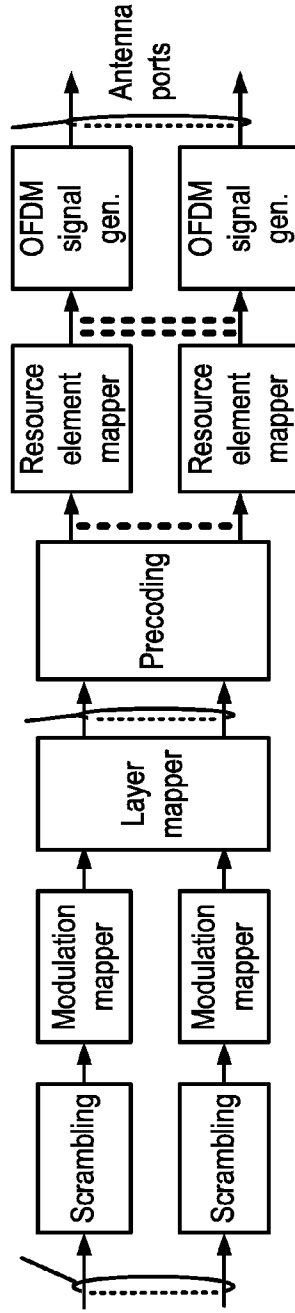
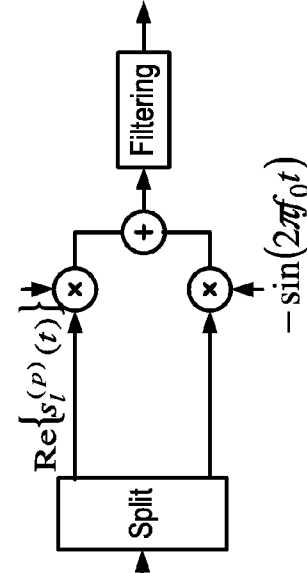
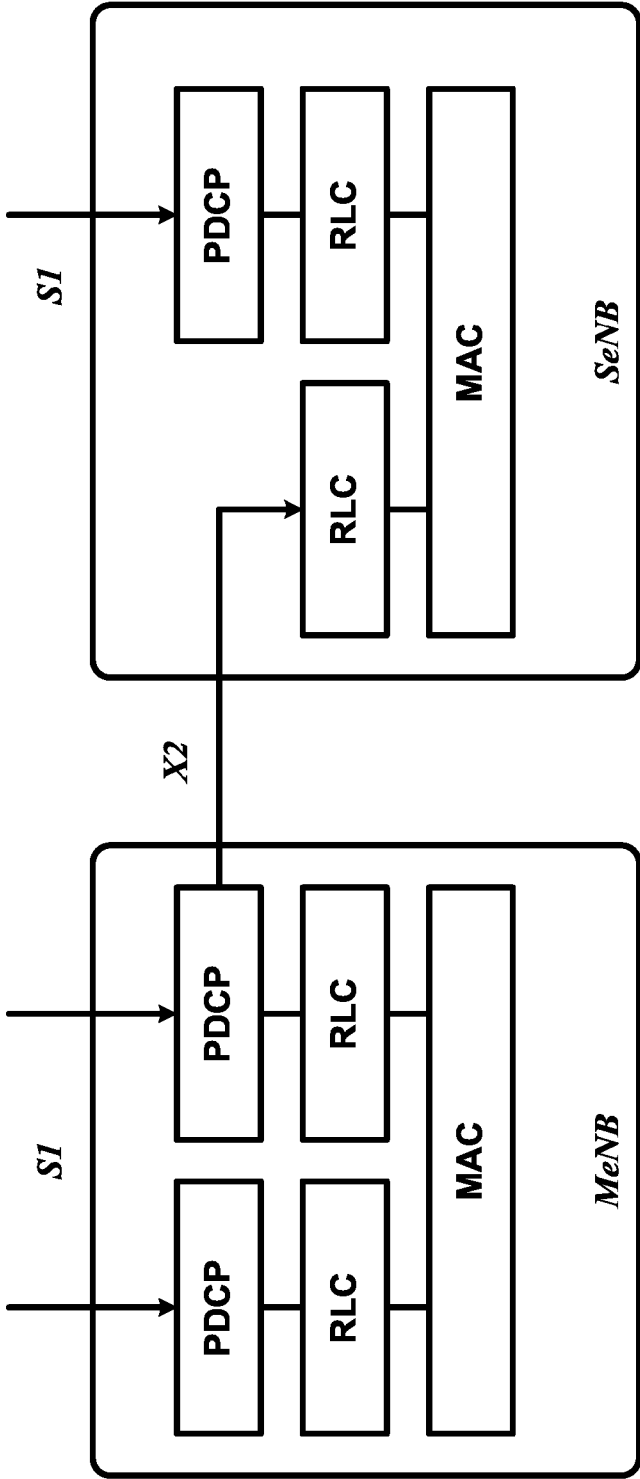

FIG. 5C Example downlink physical channel





Dual-Connectivity at eNB

FIG. 6

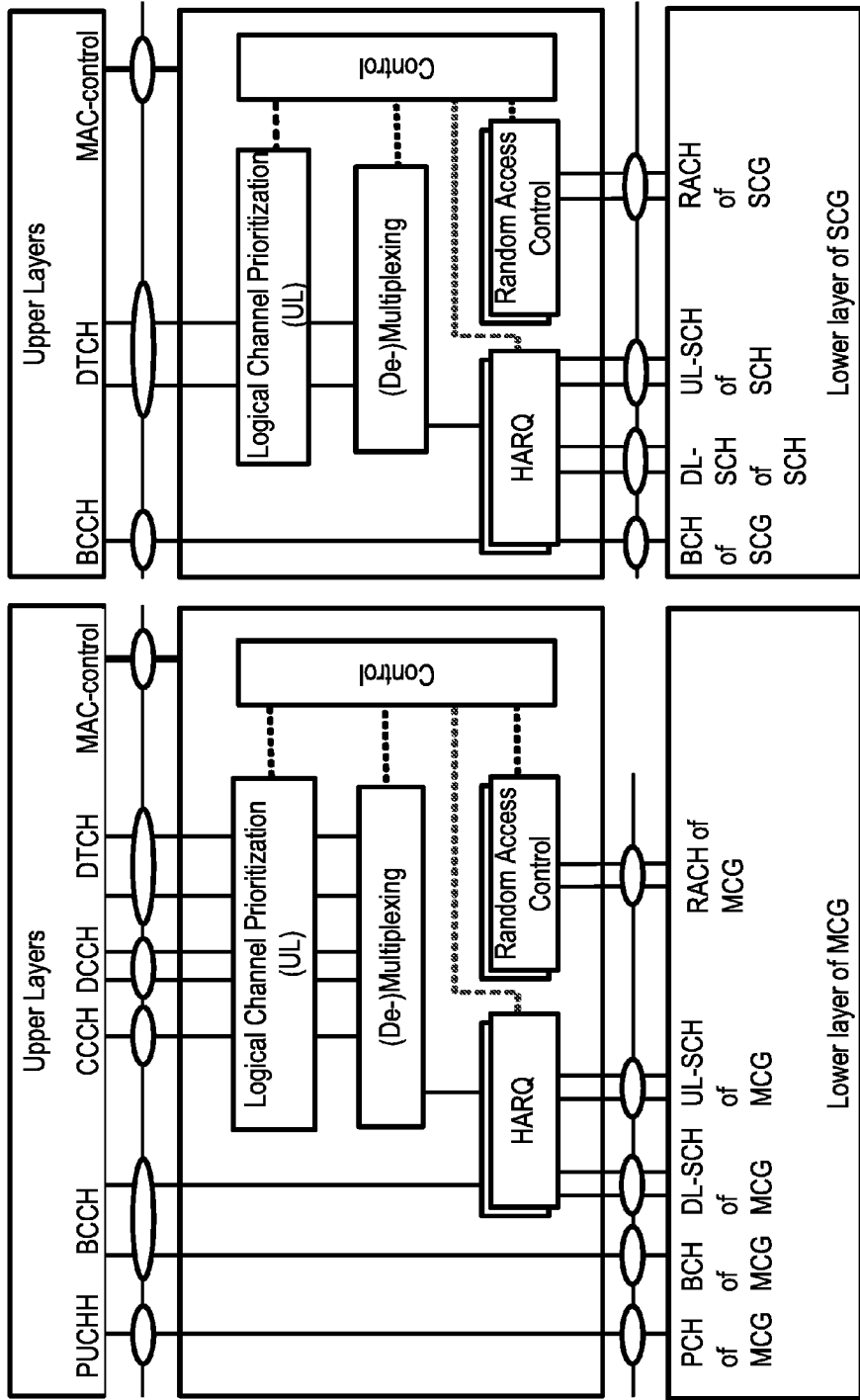

Dual-Connectivity- two MAC entities at UE side

FIG. 7



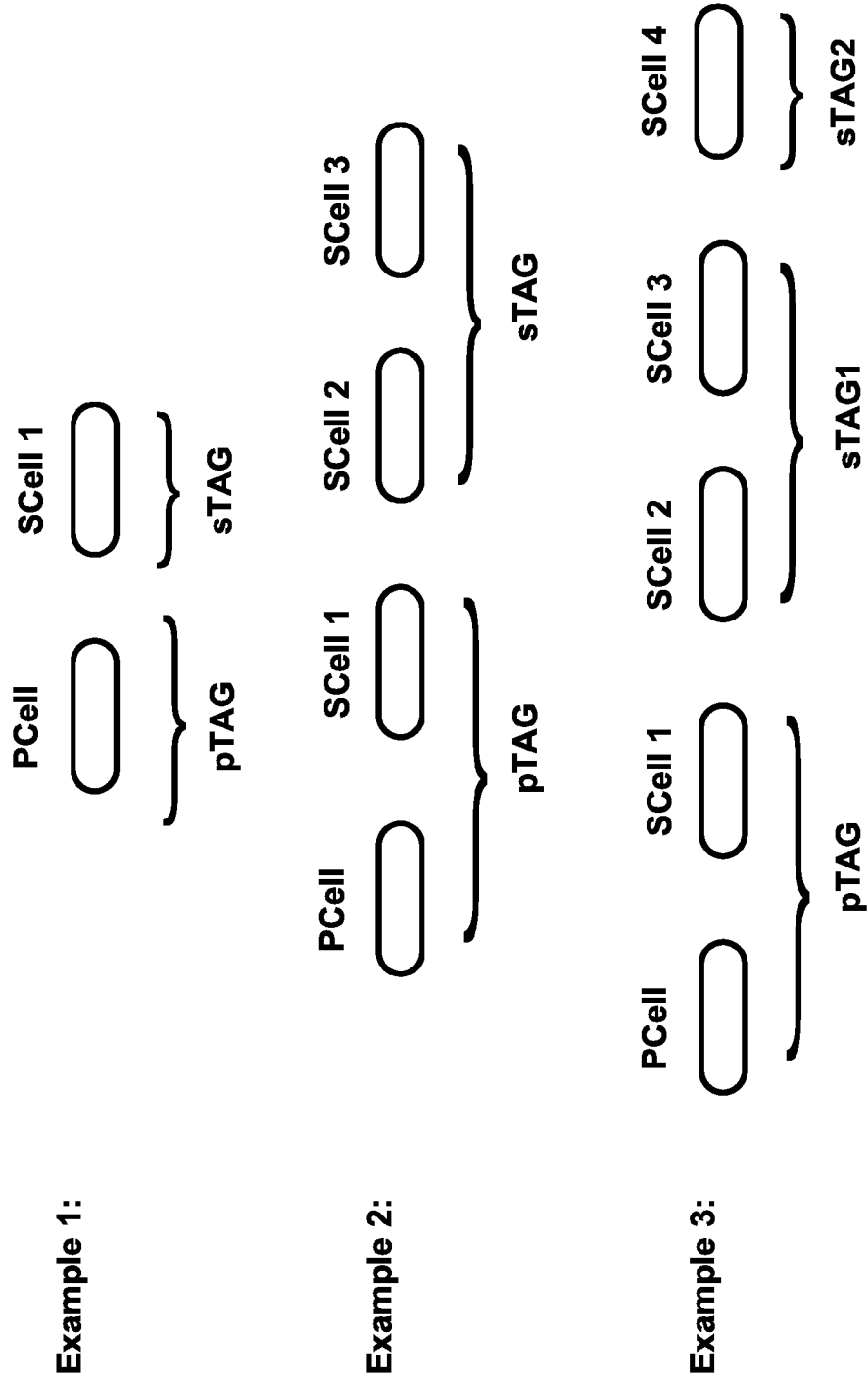

FIG. 8

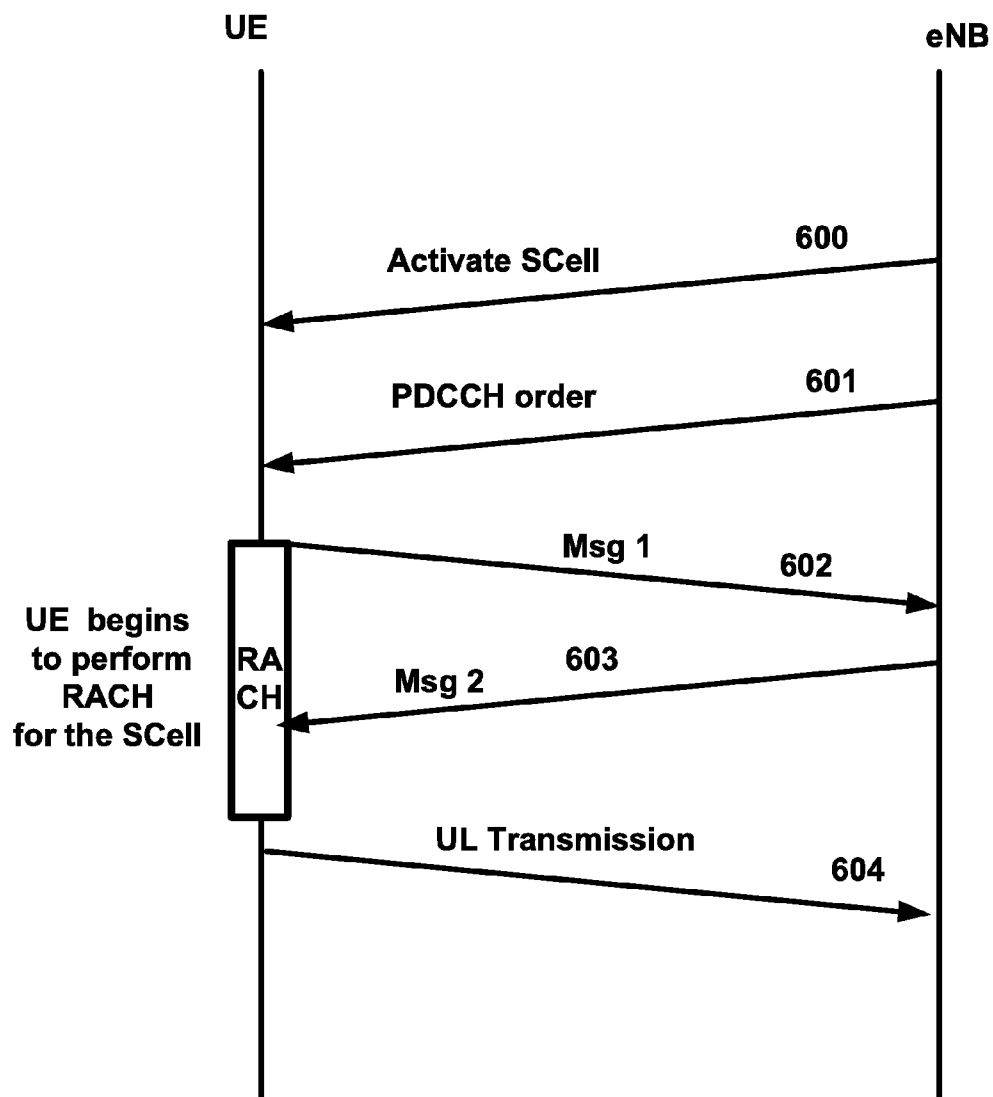

FIG. 9

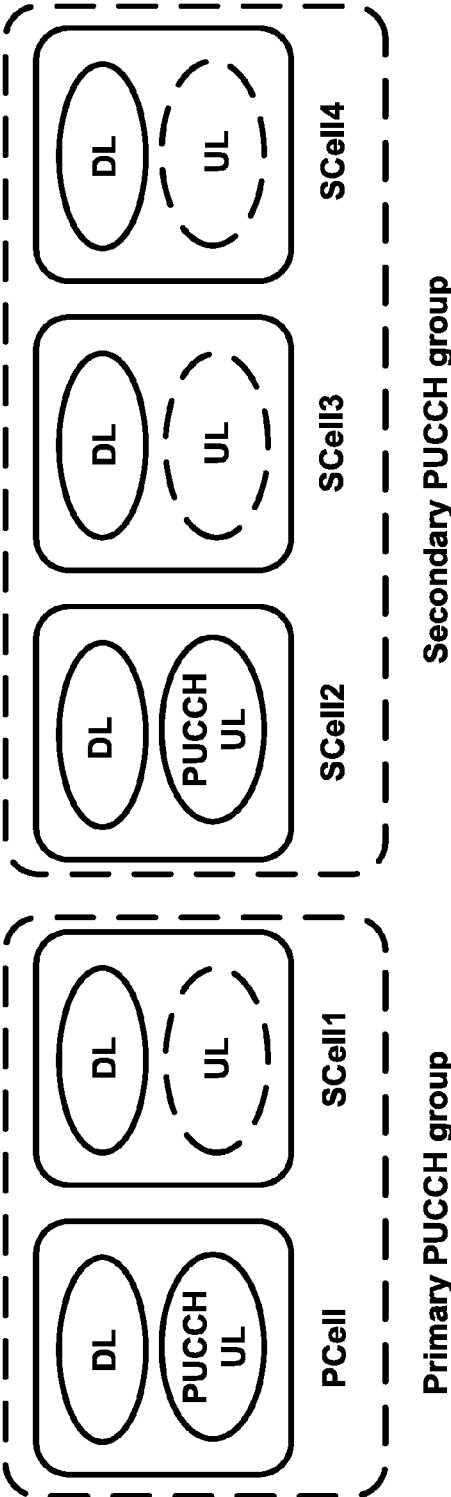

FIG. 10

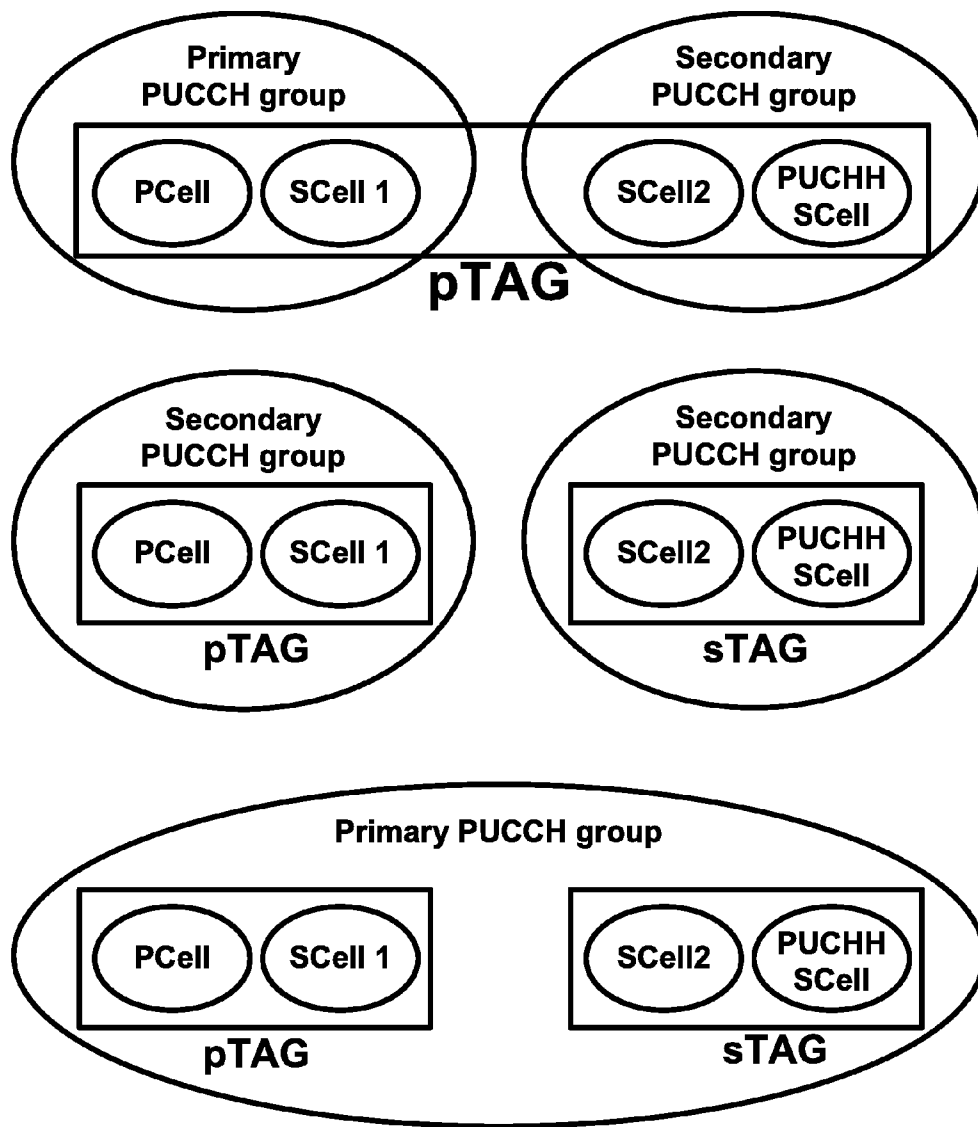

FIG. 11

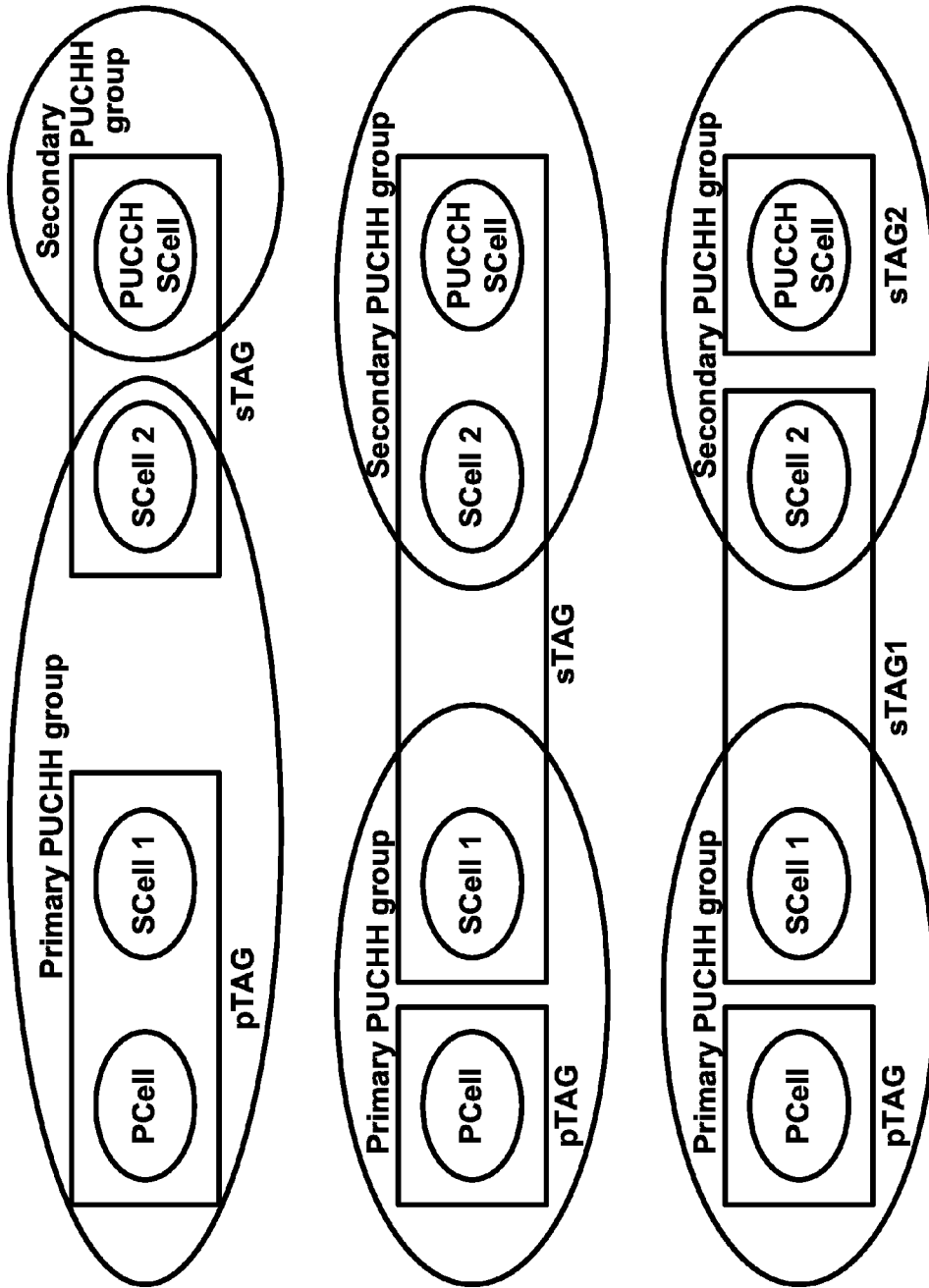

FIG. 12

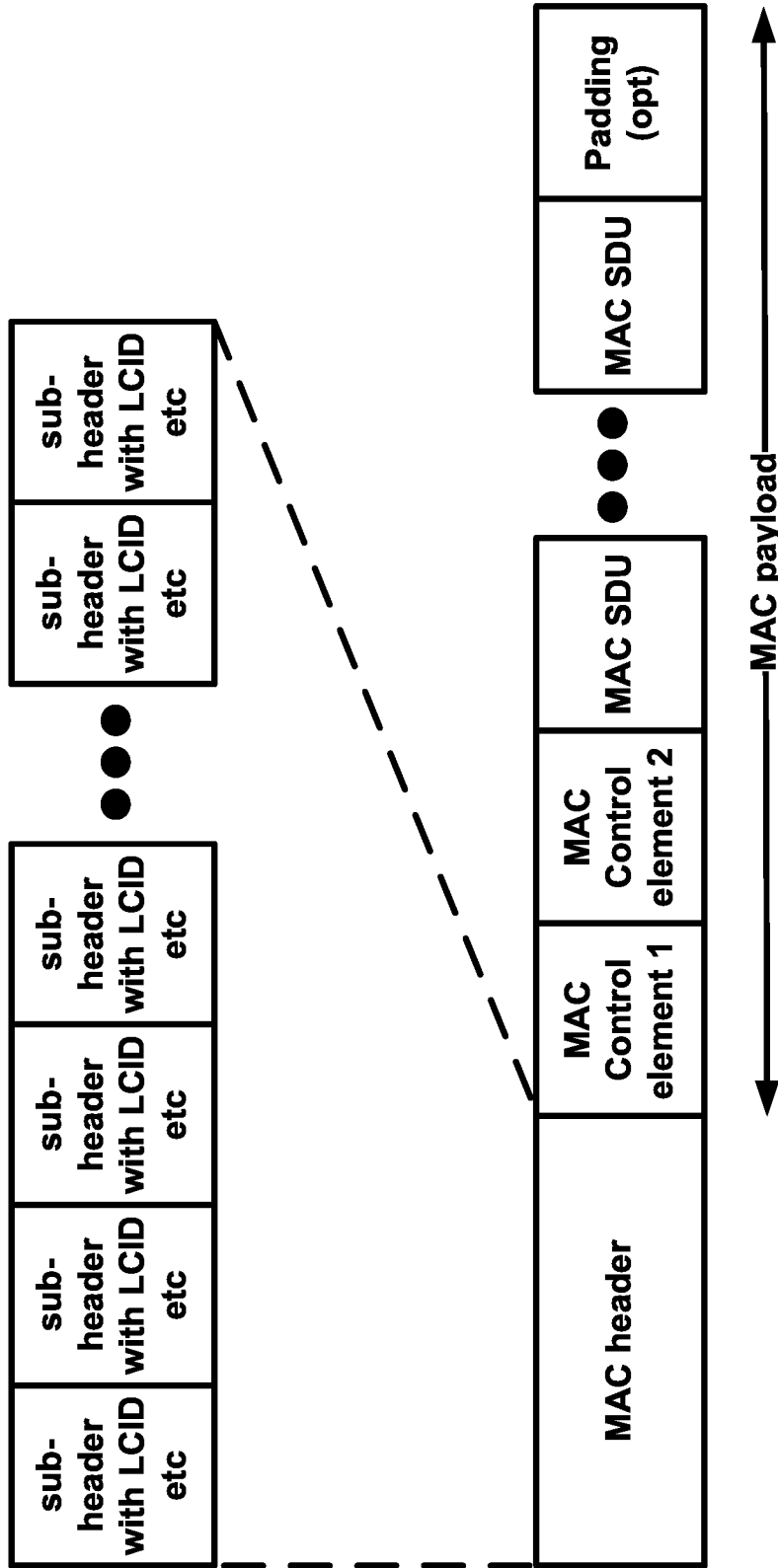

FIG. 13

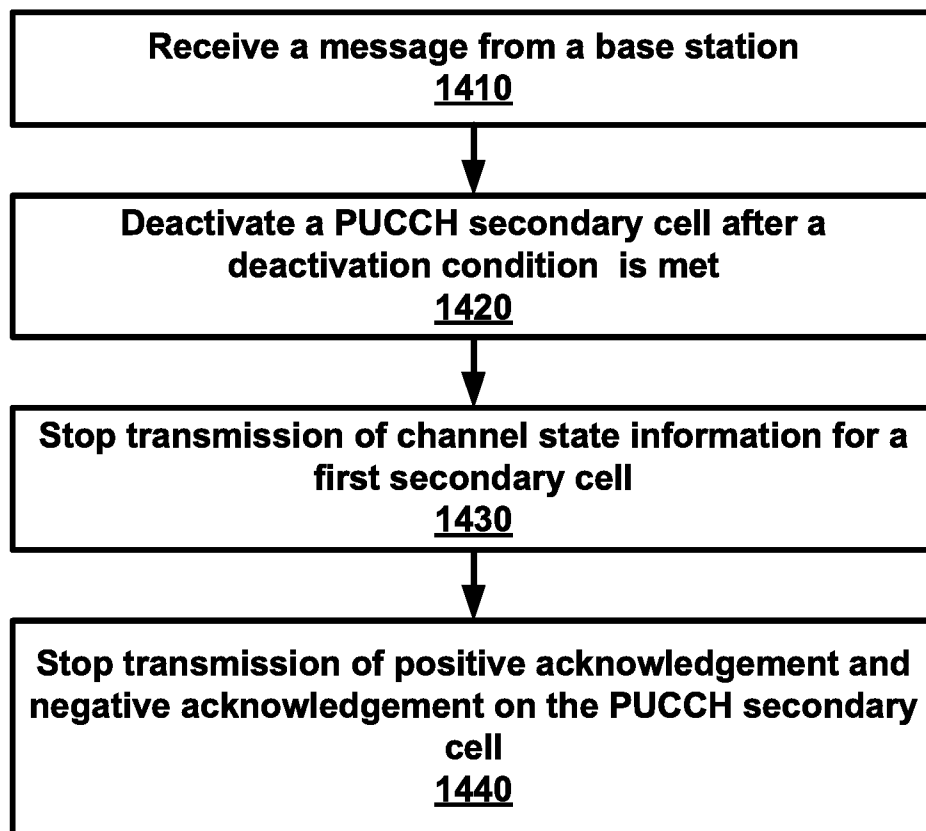
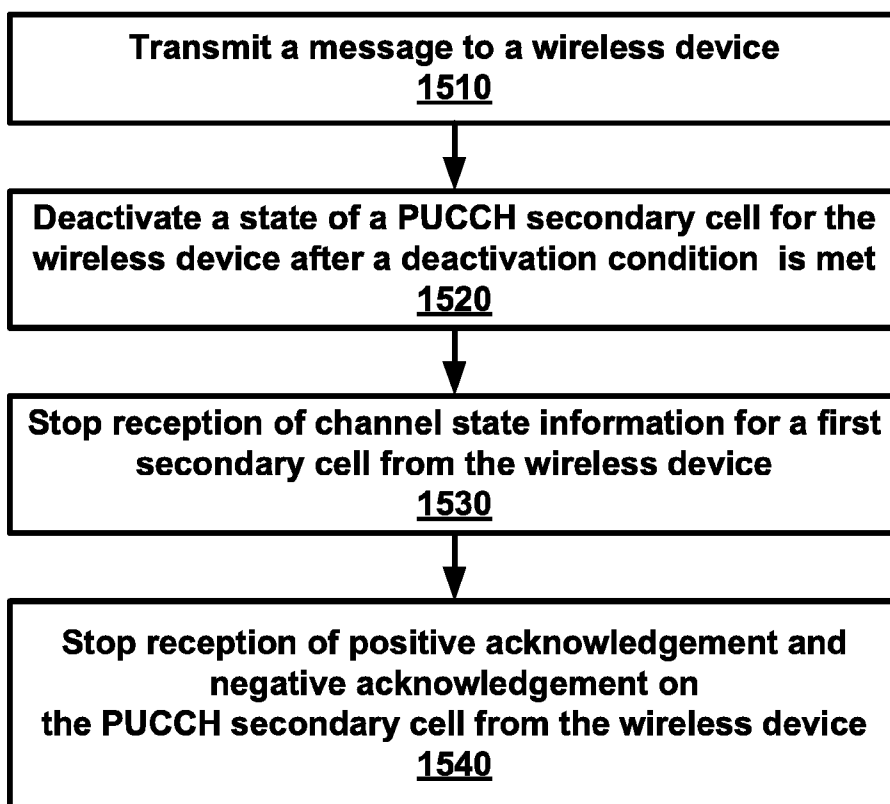
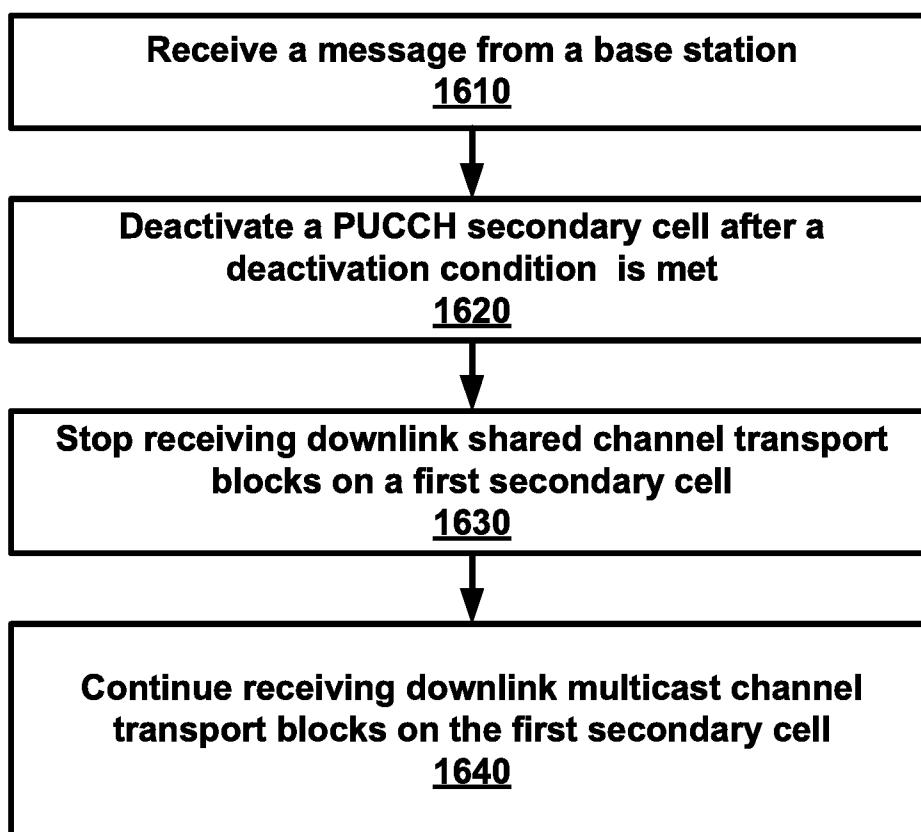

FIG. 14

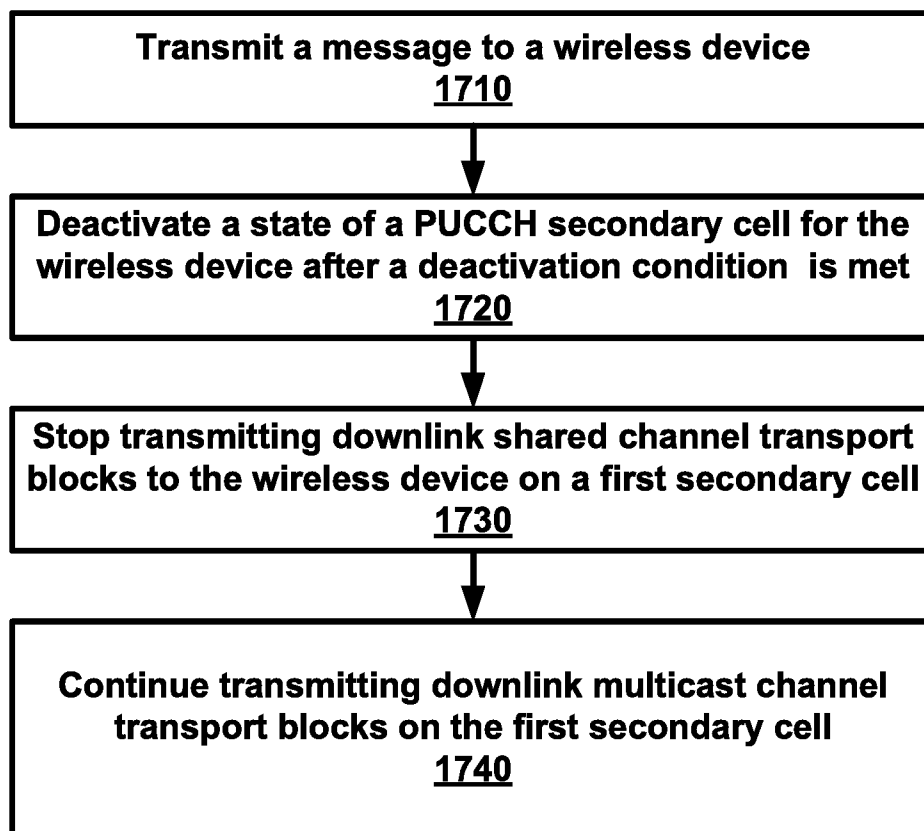

**FIG. 15**





**FIG. 16**



**FIG. 17**

## SECONDARY CELL AND CONTROL CHANNEL IN A WIRELESS DEVICE AND WIRELESS NETWORK

### CROSS-REFERENCE TO RELATED APPLICATIONS

[0001] This application claims the benefit of U.S. Provisional Application No. 62/130,504, filed Mar. 9, 2015, which is hereby incorporated by reference in its entirety.

### BRIEF DESCRIPTION OF THE SEVERAL VIEWS OF THE DRAWINGS

[0002] Examples of several of the various embodiments of the present invention are described herein with reference to the drawings.

[0003] FIG. 1 is a diagram depicting example sets of OFDM subcarriers as per an aspect of an embodiment of the present invention.

[0004] FIG. 2 is a diagram depicting an example transmission time and reception time for two carriers in a carrier group as per an aspect of an embodiment of the present invention.

[0005] FIG. 3 is a diagram depicting OFDM radio resources as per an aspect of an embodiment of the present invention.

[0006] FIG. 4 is a block diagram of a base station and a wireless device as per an aspect of an embodiment of the present invention.

[0007] FIG. 5A, FIG. 5B, FIG. 5C and FIG. 5D are example diagrams for uplink and downlink signal transmission as per an aspect of an embodiment of the present invention.

[0008] FIG. 6 is an example diagram for a protocol structure with CA and DC as per an aspect of an embodiment of the present invention.

[0009] FIG. 7 is an example diagram for a protocol structure with CA and DC as per an aspect of an embodiment of the present invention.

[0010] FIG. 8 shows example TAG configurations as per an aspect of an embodiment of the present invention.

[0011] FIG. 9 is an example message flow in a random access process in a secondary TAG as per an aspect of an embodiment of the present invention.

[0012] FIG. 10 is an example grouping of cells into PUCCH groups as per an aspect of an embodiment of the present invention.

[0013] FIG. 11 illustrates example groupings of cells into one or more PUCCH groups and one or more TAGs as per an aspect of an embodiment of the present invention.

[0014] FIG. 12 illustrates example groupings of cells into one or more PUCCH groups and one or more TAGs as per an aspect of an embodiment of the present invention.

[0015] FIG. 13 is an example MAC PDU as per an aspect of an embodiment of the present invention.

[0016] FIG. 14 is an example flow diagram as per an aspect of an embodiment of the present invention.

[0017] FIG. 15 is an example flow diagram as per an aspect of an embodiment of the present invention.

[0018] FIG. 16 is an example flow diagram as per an aspect of an embodiment of the present invention.

[0019] FIG. 17 is an example flow diagram as per an aspect of an embodiment of the present invention.

### DETAILED DESCRIPTION OF EMBODIMENTS

[0020] Example embodiments of the present invention enable operation of multiple physical uplink control channel (PUCCH) groups. Embodiments of the technology disclosed herein may be employed in the technical field of multicarrier communication systems. More particularly, the embodiments of the technology disclosed herein may relate to operation of PUCCH groups.

[0021] The following Acronyms are used throughout the present disclosure:

[0022] ASIC application-specific integrated circuit

[0023] BPSK binary phase shift keying

[0024] CA carrier aggregation

[0025] CSI channel state information

[0026] CDMA code division multiple access

[0027] CSS common search space

[0028] CPLD complex programmable logic devices

[0029] CC component carrier

[0030] DL downlink

[0031] DCI downlink control information

[0032] DC dual connectivity

[0033] EPC evolved packet core

[0034] E-UTRAN evolved-universal terrestrial radio access network

[0035] FPGA field programmable gate arrays

[0036] FDD frequency division multiplexing

[0037] HDL hardware description languages

[0038] HARQ hybrid automatic repeat request

[0039] IE information element

[0040] LTE long term evolution

[0041] MCG master cell group

[0042] MeNB master evolved node B

[0043] MIB master information block

[0044] MAC media access control

[0045] MAC media access control

[0046] MME mobility management entity

[0047] NAS non-access stratum

[0048] OFDM orthogonal frequency division multiplexing

[0049] PDCP packet data convergence protocol

[0050] PDU packet data unit

[0051] PHY physical

[0052] PDCCH physical downlink control channel

[0053] PHICH physical HARQ indicator channel

[0054] PUCCH physical uplink control channel

[0055] PUSCH physical uplink shared channel

[0056] PCell primary cell

[0057] PCell primary cell

[0058] PCC primary component carrier

[0059] PSCell primary secondary cell

[0060] pTAG primary timing advance group

[0061] QAM quadrature amplitude modulation

[0062] QPSK quadrature phase shift keying

[0063] RBG Resource Block Groups

[0064] RLC radio link control

[0065] RRC radio resource control

[0066] RA random access

[0067] RB resource blocks

[0068] SCC secondary component carrier

[0069] SCell secondary cell

[0070] SCell secondary cells

[0071] SCG secondary cell group

[0072] SeNB secondary evolved node B

[0073] sTAGs secondary timing advance group

[0074] SDU service data unit

[0075] S-GW serving gateway  
 [0076] SRB signaling radio bearer  
 [0077] SC-OFDM single carrier-OFDM  
 [0078] SFN system frame number  
 [0079] SIB system information block  
 [0080] TAI tracking area identifier  
 [0081] TAT time alignment timer  
 [0082] TDD time division duplexing  
 [0083] TDMA time division multiple access  
 [0084] TA timing advance  
 [0085] TAG timing advance group  
 [0086] TB transport block  
 [0087] UL uplink  
 [0088] UE user equipment  
 [0089] VHDL VHSIC hardware description language  
 [0090] Example embodiments of the invention may be implemented using various physical layer modulation and transmission mechanisms. Example transmission mechanisms may include, but are not limited to: CDMA, OFDM, TDMA, Wavelet technologies, and/or the like. Hybrid transmission mechanisms such as TDMA/CDMA, and OFDM/CDMA may also be employed. Various modulation schemes may be applied for signal transmission in the physical layer. Examples of modulation schemes include, but are not limited to: phase, amplitude, code, a combination of these, and/or the like. An example radio transmission method may implement QAM using BPSK, QPSK, 16-QAM, 64-QAM, 256-QAM, and/or the like. Physical radio transmission may be enhanced by dynamically or semi-dynamically changing the modulation and coding scheme depending on transmission requirements and radio conditions.

[0091] FIG. 1 is a diagram depicting example sets of OFDM subcarriers as per an aspect of an embodiment of the present invention. As illustrated in this example, arrow(s) in the diagram may depict a subcarrier in a multicarrier OFDM system. The OFDM system may use technology such as OFDM technology, SC-OFDM technology, or the like. For example, arrow 101 shows a subcarrier transmitting information symbols. FIG. 1 is for illustration purposes, and a typical multicarrier OFDM system may include more subcarriers in a carrier. For example, the number of subcarriers in a carrier may be in the range of 10 to 10,000 subcarriers. FIG. 1 shows two guard bands 106 and 107 in a transmission band. As illustrated in FIG. 1, guard band 106 is between subcarriers 103 and subcarriers 104. The example set of subcarriers A 102 includes subcarriers 103 and subcarriers 104. FIG. 1 also illustrates an example set of subcarriers B 105. As illustrated, there is no guard band between any two subcarriers in the example set of subcarriers B 105. Carriers in a multicarrier OFDM communication system may be contiguous carriers, non-contiguous carriers, or a combination of both contiguous and non-contiguous carriers.

[0092] FIG. 2 is a diagram depicting an example transmission time and reception time for two carriers as per an aspect of an embodiment of the present invention. A multicarrier OFDM communication system may include one or more carriers, for example, ranging from 1 to 10 carriers. Carrier A 204 and carrier B 205 may have the same or different timing structures. Although FIG. 2 shows two synchronized carriers, carrier A 204 and carrier B 205 may or may not be synchronized with each other. Different radio frame structures may be supported for FDD and TDD duplex mechanisms. FIG. 2 shows an example FDD frame timing. Downlink and uplink transmissions may be organized into radio frames 201. In this

example, radio frame duration is 10 msec. Other frame durations, for example, in the range of 1 to 100 msec may also be supported. In this example, each 10 ms radio frame 201 may be divided into ten equally sized subframes 202. Other subframe durations such as including 0.5 msec, 1 msec, 2 msec, and 5 msec may also be supported. Subframe(s) may consist of two or more slots (e.g. slots 206 and 207). For the example of FDD, 10 subframes may be available for downlink transmission and 10 subframes may be available for uplink transmissions in each 10 ms interval. Uplink and downlink transmissions may be separated in the frequency domain. Slot(s) may include a plurality of OFDM symbols 203. The number of OFDM symbols 203 in a slot 206 may depend on the cyclic prefix length and subcarrier spacing.

[0093] FIG. 3 is a diagram depicting OFDM radio resources as per an aspect of an embodiment of the present invention. The resource grid structure in time 304 and frequency 305 is illustrated in FIG. 3. The quantity of downlink subcarriers or RBs (in this example 6 to 100 RBs) may depend, at least in part, on the downlink transmission bandwidth 306 configured in the cell. The smallest radio resource unit may be called a resource element (e.g. 301). Resource elements may be grouped into resource blocks (e.g. 302). Resource blocks may be grouped into larger radio resources called Resource Block Groups (RBG) (e.g. 303). The transmitted signal in slot 206 may be described by one or several resource grids of a plurality of subcarriers and a plurality of OFDM symbols. Resource blocks may be used to describe the mapping of certain physical channels to resource elements. Other pre-defined groupings of physical resource elements may be implemented in the system depending on the radio technology. For example, 24 subcarriers may be grouped as a radio block for a duration of 5 msec. In an illustrative example, a resource block may correspond to one slot in the time domain and 180 kHz in the frequency domain (for 15 KHz subcarrier bandwidth and 12 subcarriers).

[0094] FIG. 5A, FIG. 5B, FIG. 5C and FIG. 5D are example diagrams for uplink and downlink signal transmission as per an aspect of an embodiment of the present invention. FIG. 5A shows an example uplink physical channel. The baseband signal representing the physical uplink shared channel may perform the following processes. These functions are illustrated as examples and it is anticipated that other mechanisms may be implemented in various embodiments. The functions may comprise scrambling, modulation of scrambled bits to generate complex-valued symbols, mapping of the complex-valued modulation symbols onto one or several transmission layers, transform precoding to generate complex-valued symbols, precoding of the complex-valued symbols, mapping of precoded complex-valued symbols to resource elements, generation of complex-valued time-domain SC-FDMA signal for each antenna port, and/or the like.

[0095] Example modulation and up-conversion to the carrier frequency of the complex-valued SC-FDMA baseband signal for each antenna port and/or the complex-valued PRACH baseband signal is shown in FIG. 5B. Filtering may be employed prior to transmission.

[0096] An example structure for Downlink Transmissions is shown in FIG. 5C. The baseband signal representing a downlink physical channel may perform the following processes. These functions are illustrated as examples and it is anticipated that other mechanisms may be implemented in various embodiments. The functions include scrambling of coded bits in each of the codewords to be transmitted on a

physical channel; modulation of scrambled bits to generate complex-valued modulation symbols; mapping of the complex-valued modulation symbols onto one or several transmission layers; precoding of the complex-valued modulation symbols on each layer for transmission on the antenna ports; mapping of complex-valued modulation symbols for each antenna port to resource elements; generation of complex-valued time-domain OFDM signal for each antenna port, and/or the like.

[0097] Example modulation and up-conversion to the carrier frequency of the complex-valued OFDM baseband signal for each antenna port is shown in FIG. 5D. Filtering may be employed prior to transmission.

[0098] FIG. 4 is an example block diagram of a base station 401 and a wireless device 406, as per an aspect of an embodiment of the present invention. A communication network 400 may include at least one base station 401 and at least one wireless device 406. The base station 401 may include at least one communication interface 402, at least one processor 403, and at least one set of program code instructions 405 stored in non-transitory memory 404 and executable by the at least one processor 403. The wireless device 406 may include at least one communication interface 407, at least one processor 408, and at least one set of program code instructions 410 stored in non-transitory memory 409 and executable by the at least one processor 408. Communication interface 402 in base station 401 may be configured to engage in communication with communication interface 407 in wireless device 406 via a communication path that includes at least one wireless link 411. Wireless link 411 may be a bi-directional link. Communication interface 407 in wireless device 406 may also be configured to engage in a communication with communication interface 402 in base station 401. Base station 401 and wireless device 406 may be configured to send and receive data over wireless link 411 using multiple frequency carriers. According to some of the various aspects of embodiments, transceiver(s) may be employed. A transceiver is a device that includes both a transmitter and receiver. Transceivers may be employed in devices such as wireless devices, base stations, relay nodes, and/or the like. Example embodiments for radio technology implemented in communication interface 402, 407 and wireless link 411 are illustrated are FIG. 1, FIG. 2, FIG. 3, FIG. 5, and associated text.

[0099] An interface may be a hardware interface, a firmware interface, a software interface, and/or a combination thereof. The hardware interface may include connectors, wires, electronic devices such as drivers, amplifiers, and/or the like. A software interface may include code stored in a memory device to implement protocol(s), protocol layers, communication drivers, device drivers, combinations thereof, and/or the like. A firmware interface may include a combination of embedded hardware and code stored in and/or in communication with a memory device to implement connections, electronic device operations, protocol(s), protocol layers, communication drivers, device drivers, hardware operations, combinations thereof, and/or the like.

[0100] The term configured may relate to the capacity of a device whether the device is in an operational or non-operational state. Configured may also refer to specific settings in a device that effect the operational characteristics of the device whether the device is in an operational or non-operational state. In other words, the hardware, software, firmware, registers, memory values, and/or the like may be “configured” within a device, whether the device is in an operational or

nonoperational state, to provide the device with specific characteristics. Terms such as “a control message to cause in a device” may mean that a control message has parameters that may be used to configure specific characteristics in the device, whether the device is in an operational or non-operational state.

[0101] According to some of the various aspects of embodiments, an LTE network may include a multitude of base stations, providing a user plane PDCP/RLC/MAC/PHY and control plane (RRC) protocol terminations towards the wireless device. The base station(s) may be interconnected with other base station(s) (e.g. employing an X2 interface). The base stations may also be connected employing, for example, an S1 interface to an EPC. For example, the base stations may be interconnected to the MME employing the S1-MME interface and to the S-G) employing the S1-U interface. The S1 interface may support a many-to-many relation between MMEs/Serving Gateways and base stations. A base station may include many sectors for example: 1, 2, 3, 4, or 6 sectors. A base station may include many cells, for example, ranging from 1 to 50 cells or more. A cell may be categorized, for example, as a primary cell or secondary cell. At RRC connection establishment/re-establishment/handover, one serving cell may provide the NAS (non-access stratum) mobility information (e.g. TAI), and at RRC connection re-establishment/handover, one serving cell may provide the security input. This cell may be referred to as the Primary Cell (PCell). In the downlink, the carrier corresponding to the PCell may be the Downlink Primary Component Carrier (DL PCC), while in the uplink, it may be the Uplink Primary Component Carrier (UL PCC). Depending on wireless device capabilities, Secondary Cells (SCells) may be configured to form together with the PCell a set of serving cells. In the downlink, the carrier corresponding to an SCell may be a Downlink Secondary Component Carrier (DL SCC), while in the uplink, it may be an Uplink Secondary Component Carrier (UL SCC). An SCell may or may not have an uplink carrier.

[0102] A cell, comprising a downlink carrier and optionally an uplink carrier, may be assigned a physical cell ID and a cell index. A carrier (downlink or uplink) may belong to only one cell. The cell ID or Cell index may also identify the downlink carrier or uplink carrier of the cell (depending on the context it is used). In the specification, cell ID may be equally referred to a carrier ID, and cell index may be referred to carrier index. In implementation, the physical cell ID or cell index may be assigned to a cell. A cell ID may be determined using a synchronization signal transmitted on a downlink carrier. A cell index may be determined using RRC messages. For example, when the specification refers to a first physical cell ID for a first downlink carrier, the specification may mean the first physical cell ID is for a cell comprising the first downlink carrier. The same concept may apply to, for example, carrier activation. When the specification indicates that a first carrier is activated, the specification may equally mean that the cell comprising the first carrier is activated.

[0103] Embodiments may be configured to operate as needed. The disclosed mechanism may be performed when certain criteria are met, for example, in a wireless device, a base station, a radio environment, a network, a combination of the above, and/or the like. Example criteria may be based, at least in part, on for example, traffic load, initial system set up, packet sizes, traffic characteristics, a combination of the above, and/or the like. When the one or more criteria are met, various example embodiments may be applied. Therefore, it

may be possible to implement example embodiments that selectively implement disclosed protocols.

**[0104]** A base station may communicate with a mix of wireless devices. Wireless devices may support multiple technologies, and/or multiple releases of the same technology. Wireless devices may have some specific capability(ies) depending on its wireless device category and/or capability (ies). A base station may comprise multiple sectors. When this disclosure refers to a base station communicating with a plurality of wireless devices, this disclosure may refer to a subset of the total wireless devices in a coverage area. This disclosure may refer to, for example, a plurality of wireless devices of a given LTE release with a given capability and in a given sector of the base station. The plurality of wireless devices in this disclosure may refer to a selected plurality of wireless devices, and/or a subset of total wireless devices in a coverage area which perform according to disclosed methods, and/or the like. There may be a plurality of wireless devices in a coverage area that may not comply with the disclosed methods, for example, because those wireless devices perform based on older releases of LTE technology.

**[0105]** FIG. 6 and FIG. 7 are example diagrams for protocol structure with CA and DC as per an aspect of an embodiment of the present invention. E-UTRAN may support Dual Connectivity (DC) operation whereby a multiple RX/TX UE in RRC\_CONNECTED may be configured to utilize radio resources provided by two schedulers located in two eNBs connected via a non-ideal backhaul over the X2 interface. eNBs involved in DC for a certain UE may assume two different roles: an eNB may either act as an MeNB or as an SeNB. In DC a UE may be connected to one MeNB and one SeNB. Mechanisms implemented in DC may be extended to cover more than two eNBs. FIG. 7 illustrates one example structure for the UE side MAC entities when a Master Cell Group (MCG) and a Secondary Cell Group (SCG) are configured, and it may not restrict implementation. Media Broadcast Multicast Service (MBMS) reception is not shown in this figure for simplicity.

**[0106]** In DC, the radio protocol architecture that a particular bearer uses may depend on how the bearer is setup. Three alternatives may exist, an MCG bearer, an SCG bearer and a split bearer as shown in FIG. 6. RRC may be located in MeNB and SRBs may be configured as a MCG bearer type and may use the radio resources of the MeNB. DC may also be described as having at least one bearer configured to use radio resources provided by the SeNB. DC may or may not be configured/implemented in example embodiments of the invention.

**[0107]** In the case of DC, the UE may be configured with two MAC entities: one MAC entity for MeNB, and one MAC entity for SeNB. In DC, the configured set of serving cells for a UE may comprise of two subsets: the Master Cell Group (MCG) containing the serving cells of the MeNB, and the Secondary Cell Group (SCG) containing the serving cells of the SeNB. For a SCG, one or more of the following may be applied: at least one cell in the SCG has a configured UL CC and one of them, named PSCell (or PCell of SCG, or sometimes called PCell), is configured with PUCCH resources; when the SCG is configured, there may be at least one SCG bearer or one Split bearer; upon detection of a physical layer problem or a random access problem on a PSCell, or the maximum number of RLC retransmissions has been reached associated with the SCG, or upon detection of an access problem on a PSCell during a SCG addition or a SCG change:

a RRC connection re-establishment procedure may not be triggered, UL transmissions towards cells of the SCG are stopped, a MeNB may be informed by the UE of a SCG failure type, for split bearer, the DL data transfer over the MeNB is maintained; the RLC AM bearer may be configured for the split bearer; like PCell, PSCell may not be de-activated; PSCell may be changed with a SCG change (e.g. with security key change and a RACH procedure); and/or neither a direct bearer type change between a Split bearer and a SCG bearer nor simultaneous configuration of a SCG and a Split bearer are supported.

**[0108]** With respect to the interaction between a MeNB and a SeNB, one or more of the following principles may be applied: the MeNB may maintain the RRM measurement configuration of the UE and may, (e.g. based on received measurement reports or traffic conditions or bearer types), decide to ask a SeNB to provide additional resources (serving cells) for a UE; upon receiving a request from the MeNB, a SeNB may create a container that may result in the configuration of additional serving cells for the UE (or decide that it has no resource available to do so); for UE capability coordination, the MeNB may provide (part of) the AS configuration and the UE capabilities to the SeNB; the MeNB and the SeNB may exchange information about a UE configuration by employing of RRC containers (inter-node messages) carried in X2 messages; the SeNB may initiate a reconfiguration of its existing serving cells (e.g., PUCCH towards the SeNB); the SeNB may decide which cell is the PSCell within the SCG; the MeNB may not change the content of the RRC configuration provided by the SeNB; in the case of a SCG addition and a SCG SCell addition, the MeNB may provide the latest measurement results for the SCG cell(s); both a MeNB and a SeNB may know the SFN and subframe offset of each other by OAM, (e.g., for the purpose of DRX alignment and identification of a measurement gap). In an example, when adding a new SCG SCell, dedicated RRC signalling may be used for sending required system information of the cell as for CA, except for the SFN acquired from a MIB of the PSCell of a SCG.

**[0109]** According to some of the various aspects of embodiments, serving cells having an uplink to which the same time alignment (TA) applies may be grouped in a TA group (TAG). Serving cells in one TAG may use the same timing reference. For a given TAG, user equipment (UE) may use one downlink carrier as a timing reference at a given time. The UE may use a downlink carrier in a TAG as a timing reference for that TAG. For a given TAG, a UE may synchronize uplink subframe and frame transmission timing of uplink carriers belonging to the same TAG. According to some of the various aspects of embodiments, serving cells having an uplink to which the same TA applies may correspond to serving cells hosted by the same receiver. A TA group may comprise at least one serving cell with a configured uplink. A UE supporting multiple TAs may support two or more TA groups. One TA group may contain the PCell and may be called a primary TAG (pTAG). In a multiple TAG configuration, at least one TA group may not contain the PCell and may be called a secondary TAG (sTAG). Carriers within the same TA group may use the same TA value and the same timing reference. When DC is configured, cells belonging to a cell group (MCG or SCG) may be grouped into multiple TAGs including a pTAG and one or more sTAGs.

**[0110]** FIG. 8 shows example TAG configurations as per an aspect of an embodiment of the present invention. In Example

1, pTAG comprises PCell, and an sTAG comprises SCell1. In Example 2, a pTAG comprises a PCell and SCell1, and an sTAG comprises SCell2 and SCell3. In Example 3, pTAG comprises PCell and SCell1, and an sTAG1 includes SCell2 and SCell3, and sTAG2 comprises SCell4. Up to four TAGs may be supported in a cell group (MCG or SCG) and other example TAG configurations may also be provided. In various examples in this disclosure, example mechanisms are described for a pTAG and an sTAG. The operation with one example sTAG is described, and the same operation may be applicable to other sTAGs. The example mechanisms may be applied to configurations with multiple sTAGs.

**[0111]** According to some of the various aspects of embodiments, TA maintenance, pathloss reference handling and a timing reference for a pTAG may follow LTE release 10 principles in the MCG and/or SCG. The UE may need to measure downlink pathloss to calculate uplink transmit power. A pathloss reference may be used for uplink power control and/or transmission of random access preamble(s). UE may measure downlink pathloss using signals received on a pathloss reference cell. For SCell(s) in a pTAG, the choice of a pathloss reference for cells may be selected from and/or be limited to the following two options: a) the downlink SCell linked to an uplink SCell using system information block 2 (SIB2), and b) the downlink pCell. The pathloss reference for SCells in a pTAG may be configurable using RRC message(s) as a part of an SCell initial configuration and/or reconfiguration. According to some of the various aspects of embodiments, a PhysicalConfigDedicatedSCell information element (IE) of an SCell configuration may include a pathloss reference SCell (downlink carrier) for an SCell in a pTAG. The downlink SCell linked to an uplink SCell using system information block 2 (SIB2) may be referred to as the SIB2 linked downlink of the SCell. Different TAGs may operate in different bands. For an uplink carrier in an sTAG, the pathloss reference may be only configurable to the downlink SCell linked to an uplink SCell using the system information block 2 (SIB2) of the SCell.

**[0112]** To obtain initial uplink (UL) time alignment for an sTAG, an eNB may initiate an RA procedure. In an sTAG, a UE may use one of any activated SCells from this sTAG as a timing reference cell. In an example embodiment, the timing reference for SCells in an sTAG may be the SIB2 linked downlink of the SCell on which the preamble for the latest RA procedure was sent. There may be one timing reference and one time alignment timer (TAT) per TA group. A TAT for TAGs may be configured with different values. In a MAC entity, when a TAT associated with a pTAG expires: all TATs may be considered as expired, the UE may flush HARQ buffers of serving cells, the UE may clear any configured downlink assignment/uplink grants, and the RRC in the UE may release PUCCH/SRS for all configured serving cells. When the pTAG TAT is not running, an sTAG TAT may not be running. When the TAT associated with an sTAG expires: a) SRS transmissions may be stopped on the corresponding SCells, b) SRS RRC configuration may be released, c) CSI reporting configuration for corresponding SCells may be maintained, and/or d) the MAC in the UE may flush the uplink HARQ buffers of the corresponding SCells.

**[0113]** An eNB may initiate an RA procedure via a PDCCH order for an activated SCell. This PDCCH order may be sent on a scheduling cell of this SCell. When cross carrier scheduling is configured for a cell, the scheduling cell may be different than the cell that is employed for preamble trans-

mission, and the PDCCH order may include an SCell index. At least a non-contention based RA procedure may be supported for SCell(s) assigned to sTAG(s).

**[0114]** FIG. 9 is an example message flow in a random access process in a secondary TAG as per an aspect of an embodiment of the present invention. An eNB transmits an activation command 600 to activate an SCell. A preamble 602 (Msg1) may be sent by a UE in response to a PDCCH order 601 on an SCell belonging to an sTAG. In an example embodiment, preamble transmission for SCells may be controlled by the network using PDCCH format 1A. Msg2 message 603 (RAR: random access response) in response to the preamble transmission on the SCell may be addressed to RA-RNTI in a PCell common search space (CSS). Uplink packets 604 may be transmitted on the SCell in which the preamble was transmitted.

**[0115]** According to some of the various aspects of embodiments, initial timing alignment may be achieved through a random access procedure. This may involve a UE transmitting a random access preamble and an eNB responding with an initial TA command NTA (amount of timing advance) within a random access response window. The start of the random access preamble may be aligned with the start of a corresponding uplink subframe at the UE assuming NTA=0. The eNB may estimate the uplink timing from the random access preamble transmitted by the UE. The TA command may be derived by the eNB based on the estimation of the difference between the desired UL timing and the actual UL timing. The UE may determine the initial uplink transmission timing relative to the corresponding downlink of the sTAG on which the preamble is transmitted.

**[0116]** The mapping of a serving cell to a TAG may be configured by a serving eNB with RRC signaling. The mechanism for TAG configuration and reconfiguration may be based on RRC signaling. According to some of the various aspects of embodiments, when an eNB performs an SCell addition configuration, the related TAG configuration may be configured for the SCell. In an example embodiment, an eNB may modify the TAG configuration of an SCell by removing (releasing) the SCell and adding (configuring) a new SCell (with the same physical cell ID and frequency) with an updated TAG ID. The new SCell with the updated TAG ID may initially be inactive subsequent to being assigned the updated TAG ID. The eNB may activate the updated new SCell and start scheduling packets on the activated SCell. In an example implementation, it may not be possible to change the TAG associated with an SCell, but rather, the SCell may need to be removed and a new SCell may need to be added with another TAG. For example, if there is a need to move an SCell from an sTAG to a pTAG, at least one RRC message, for example, at least one RRC reconfiguration message, may be sent to the UE to reconfigure TAG configurations by releasing the SCell and then configuring the SCell as a part of the pTAG (when an SCell is added/configured without a TAG index, the SCell may be explicitly assigned to the pTAG). The PCell may not change its TA group and may always be a member of the pTAG.

**[0117]** The purpose of an RRC connection reconfiguration procedure may be to modify an RRC connection, (e.g. to establish, modify and/or release RBs, to perform handover, to setup, modify, and/or release measurements, to add, modify, and/or release SCells). If the received RRC Connection Reconfiguration message includes the sCellToReleaseList, the UE may perform an SCell release. If the received RRC

Connection Reconfiguration message includes the sCell-ToAddModList, the UE may perform SCell additions or modification.

**[0118]** In LTE Release-10 and Release-11 CA, a PUCCH is only transmitted on the PCell (PSCell) to an eNB. In LTE-Release 12 and earlier, a UE may transmit PUCCH information on one cell (PCell or PSCell) to a given eNB.

**[0119]** As the number of CA capable UEs and also the number of aggregated carriers increase, the number of PUCCHs and also the PUCCH payload size may increase. Accommodating the PUCCH transmissions on the PCell may lead to a high PUCCH load on the PCell. A PUCCH on an SCell may be introduced to offload the PUCCH resource from the PCell. More than one PUCCH may be configured for example, a PUCCH on a PCell and another PUCCH on an SCell. FIG. 10 is an example grouping of cells into PUCCH groups as per an aspect of an embodiment of the present invention. In the example embodiments, one, two or more cells may be configured with PUCCH resources for transmitting CSI/ACK/NACK to a base station. Cells may be grouped into multiple PUCCH groups, and one or more cell within a group may be configured with a PUCCH. In an example configuration, one SCell may belong to one PUCCH group. SCells with a configured PUCCH transmitted to a base station may be called a PUCCH SCell, and a cell group with a common PUCCH resource transmitted to the same base station may be called a PUCCH group.

**[0120]** In Release-12, a PUCCH can be configured on a PCell and/or a PSCell, but cannot be configured on other SCells. In an example embodiment, a UE may transmit a message indicating that the UE supports PUCCH configuration on a PCell and SCell. Such an indication may be separate from an indication of dual connectivity support by the UE. In an example embodiment, a UE may support both DC and PUCCH groups. In an example embodiment, either DC or PUCCH groups may be configured, but not both. In another example embodiment, more complicated configurations comprising both DC and PUCCH groups may be supported.

**[0121]** When a UE is capable of configuring PUCCH groups, and if a UE indicates that it supports simultaneous PUCCH/PUSCH transmission capability, it may imply that the UE supports simultaneous PUCCH/PUSCH transmission on both PCell and SCell. When multiple PUCCH groups are configured, a PUCCH may be configured or not configured with simultaneous PUCCH/PUSCH transmission.

**[0122]** In an example embodiment, PUCCH transmission to a base station on two serving cells may be realized as shown in FIG. 10. A first group of cells may employ a PUCCH on the PCell and may be called PUCCH group 1 or a primary PUCCH group. A second group of cells may employ a PUCCH on an SCell and may be called PUCCH group 2 or a secondary PUCCH group. One, two or more PUCCH groups may be configured. In an example, cells may be grouped into two PUCCH groups, and each PUCCH group may include a cell with PUCCH resources. A PCell may provide PUCCH resources for the primary PUCCH group and an SCell in the secondary PUCCH group may provide PUCCH resources for the cells in the secondary PUCCH group. In an example embodiment, no cross-carrier scheduling between cells in different PUCCH groups may be configured. When cross-carrier scheduling between cells in different PUCCH groups is not configured, ACK/NACK on PHICH channel may be

limited within a PUCCH group. Both downlink and uplink scheduling activity may be separate between cells belonging to different PUCCH groups.

**[0123]** A PUCCH on an SCell may carry HARQ-ACK and CSI information. A PCell may be configured with PUCCH resources. In an example embodiment, RRC parameters for an SCell PUCCH Power Control for a PUCCH on an SCell may be different from those of a PCell PUCCH. A Transmit Power Control command for a PUCCH on an SCell may be transmitted in DCI(s) on the SCell carrying the PUCCH.

**[0124]** UE procedures on a PUCCH transmission may be different and/or independent between PUCCH groups. For example, determination of DL HARQ-ACK timing, PUCCH resource determination for HARQ-ACK and/or CSI, Higher-layer configuration of simultaneous HARQ-ACK+CSI on a PUCCH, Higher-layer configuration of simultaneous HARQ-ACK+SRS in one subframe may be configured differently for a PUCCH PCell and a PUCCH SCell.

**[0125]** A PUCCH group may be a group of serving cells configured by a RRC and use the same serving cell in the group for transmission of a PUCCH. A Primary PUCCH group may be a PUCCH group containing a PCell. A secondary PUCCH group may be a PUCCH cell group not containing the PCell. In an example embodiment, an SCell may belong to one PUCCH group. When one SCell belongs to a PUCCH group, ACK/NACK or CSI for that SCell may be transmitted over the PUCCH in that PUCCH group (over PUCCH SCell or PUCCH PCell). A PUCCH on an SCell may reduce the PUCCH load on the PCell. A PUCCH SCell may be employed for UCI transmission of SCells in the corresponding PUCCH group.

**[0126]** In an example embodiment, a flexible PUCCH configuration in which control signalling is sent on one, two or more PUCCHs may be possible. Beside the PCell, it may be possible to configure a selected number of SCells for PUCCH transmission (herein called PUCCH SCells). Control signalling information conveyed in a certain PUCCH SCell may be related to a set of SCells in a corresponding PUCCH group that are configured by the network via RRC signalling.

**[0127]** PUCCH control signalling carried by a PUCCH channel may be distributed between a PCell and SCells for off-loading or robustness purposes. By enabling a PUCCH in an SCell, it may be possible to distribute the overall CSI reports for a given UE between a PCell and a selected number of SCells (e.g. PUCCH SCells), thereby limiting PUCCH CSI resource consumption by a given UE on a certain cell. It may be possible to map CSI reports for a certain SCell to a selected PUCCH SCell. An SCell may be assigned a certain periodicity and time-offset for transmission of control information. Periodic CSI for a serving cell may be mapped on a PUCCH (on the PCell or on a PUCCH-SCell) via RRC signalling. The possibility of distributing CSI reports, HARQ feedbacks, and/or Scheduling Requests across PUCCH SCells may provide flexibility and capacity improvements. HARQ feedback for a serving cell may be mapped on a PUCCH (on the PCell or on a PUCCH SCell) via RRC signalling.

**[0128]** In example embodiments, PUCCH transmission may be configured on a PCell, as well as one SCell in CA. An SCell PUCCH may be realized using the concept of PUCCH groups, where aggregated cells are grouped into two or more PUCCH groups. One cell from a PUCCH group may be configured to carry a PUCCH. More than 5 carriers may be configured. In the example embodiments, up to n carriers may



be aggregated. For example,  $n$  may be 16, 32, or 64. Some CCs may have non-backward compatible configurations supporting only advanced UEs (e.g. support licensed assisted access SCells). In an example embodiment, one SCell PUCCH (e.g. two PUCCH groups) may be supported. In another example embodiment, a PUCCH group concept with multiple (more than one) SCells carrying PUCCH may be employed (e.g., there can be more than two PUCCH groups).

**[0129]** In an example embodiment, a given PUCCH group may not comprise serving cells of both MCG and SCG. One of the PUCCHs may be configured on the PCell. In an example embodiment, PUCCH mapping of serving cells may be configured by RRC messages. In an example embodiment, a maximum value of an SCellIndex and a ServCellIndex may be 31 (ranging from 0 to 31). In an example, a maximum value of stag-Id may be 3. The CIF for a scheduled cell may be configured explicitly. A PUCCH SCell may be configured by giving a PUCCH configuration for an SCell. A HARQ feedback and CSI report of a PUCCH SCell may be sent on the PUCCH of that PUCCH SCell. The HARQ feedback and CSI report of a SCell may be sent on a PUCCH of a PCell if no PUCCH SCell is signalled for that SCell. The HARQ feedback and CSI report of an SCell may be sent on the PUCCH of one PUCCH SCell; hence they may not be sent on the PUCCH of different PUCCH SCell. The UE may report a Type 2 PH for serving cells configured with a PUCCH. In an example embodiment, a MAC activation/deactivation may be supported for a PUCCH SCell. An eNB may manage the activation/deactivation status for SCells. A newly added PUCCH SCell may be initially deactivated.

**[0130]** In an example embodiment, independent configuration of PUCCH groups and TAGs may be supported. FIG. 11 and FIG. 12 show example configurations of TAGs and PUCCH groups. For example, one TAG may contain multiple serving cells with a PUCCH. For example, each TAG may only comprise cells of one PUCCH group. For example, a TAG may comprise the serving cells (without a PUCCH) which belong to different PUCCH groups.

**[0131]** There may not be a one-to-one mapping between TAGs and PUCCH groups. For example, in a configuration, a PUCCH SCell may belong to primary TAG. In an example implementation, the serving cells of one PUCCH group may be in different TAGs and serving cells of one TAG may be in different PUCCH groups. Configuration of PUCCH groups and TAGs may be left to eNB implementation. In another example implementation, restriction(s) on the configuration of a PUCCH cell may be specified. For example, in an example embodiment, cells in a given PUCCH group may belong to the same TAG. In an example, an sTAG may only comprise cells of one PUCCH group. In an example, one-to-one mapping between TAGs and PUCCH groups may be implemented. In implementation, cell configurations may be limited to some of the examples. In other implementations, some or all the below configurations may be allowed.

**[0132]** In an example embodiment, for an SCell in a pTAG, the timing reference may be a PCell. For an SCell in an sTAG, the timing reference may be any activated SCell in the sTAG. For an SCell (configured with PUCCH or not) in a pTAG, a pathloss reference may be configured to be a PCell or an SIB-2 linked SCell. For an SCell in a sTAG, the pathloss reference may be the SIB-2 linked SCell. When a TAT associated with a pTAG is expired, the TAT associated with sTAGs may be considered as expired. When a TAT of an sTAG containing PUCCH SCell expires, the MAC may indicate to

an RRC to release PUCCH resource for the PUCCH group. When the TAT of an sTAG containing a PUCCH SCell is not running, the uplink transmission (PUSCH) for SCells in the secondary PUCCH group not belonging to the sTAG including the PUCCH SCell may not be impacted. The TAT expiry of an sTAG containing a PUCCH SCell may not trigger TAT expiry of other TAGs to which other SCells in the same PUCCH group belong. When the TAT associated with sTAG not containing a PUCCH SCell is not running, the wireless device may stop the uplink transmission for the SCell in the sTAG and may not impact other TAGs.

**[0133]** In an example embodiment, a MAC entity may have a configurable timer timeAlignmentTimer per TAG. The timeAlignmentTimer may be used to control how long the MAC entity considers the Serving Cells belonging to the associated TAG to be uplink time aligned. The MAC entity may, when a Timing Advance Command MAC control element is received, apply the Timing Advance Command for the indicated TAG; start or restart the timeAlignmentTimer associated with the indicated TAG. The MAC entity may, when a Timing Advance Command is received in a Random Access Response message for a serving cell belonging to a TAG and/or if the Random Access Preamble was not selected by the MAC entity, apply the Timing Advance Command for this TAG and start or restart the timeAlignmentTimer associated with this TAG. Otherwise, if the timeAlignmentTimer associated with this TAG is not running, the Timing Advance Command for this TAG may be applied and the timeAlignmentTimer associated with this TAG started. When the contention resolution is considered not successful, a timeAlignmentTimer associated with this TAG may be stopped. Otherwise, the MAC entity may ignore the received Timing Advance Command

**[0134]** Example embodiments of the invention may enable operation of multiple PUCCH groups. Other example embodiments may comprise a non-transitory tangible computer readable media comprising instructions executable by one or more processors to cause operation of PUCCH groups. Yet other example embodiments may comprise an article of manufacture that comprises a non-transitory tangible computer readable machine-accessible medium having instructions encoded thereon for enabling programmable hardware to cause a device (e.g. wireless communicator, UE, base station, etc.) to enable operation of PUCCH groups. The device may include processors, memory, interfaces, and/or the like. Other example embodiments may comprise communication networks comprising devices such as base stations, wireless devices (or user equipment: UE), servers, switches, antennas, and/or the like. In an example embodiment one or more TAGs may be configured along with PUCCH group configuration.

**[0135]** FIG. 13 is an example MAC PDU as per an aspect of an embodiment of the present invention. In an example embodiment, a MAC PDU may comprise of a MAC header, zero or more MAC Service Data Units (MAC SDU), zero or more MAC control elements, and optionally padding. The MAC header and the MAC SDUs may be of variable sizes. A MAC PDU header may comprise one or more MAC PDU subheaders. A subheader may correspond to either a MAC SDU, a MAC control element or padding. A MAC PDU subheader may comprise header fields R, F2, E, LCID, F, and/or L. The last subheader in the MAC PDU and subheaders for fixed sized MAC control elements may comprise the four header fields R, F2, E, and/or LCID. A MAC PDU

subheader corresponding to padding may comprise the four header fields R, F2, E, and/or LCID.

**[0136]** In an example embodiment, LCID or Logical Channel ID field may identify the logical channel instance of the corresponding MAC SDU or the type of the corresponding MAC control element or padding. There may be one LCID field for a MAC SDU, MAC control element or padding included in the MAC PDU. In addition to that, one or two additional LCID fields may be included in the MAC PDU when single-byte or two-byte padding is required but cannot be achieved by padding at the end of the MAC PDU. The LCID field size may be, e.g. 5 bits. L or the Length field may indicate the length of the corresponding MAC SDU or variable-sized MAC control element in bytes. There may be one L field per MAC PDU subheader except for the last subheader and subheaders corresponding to fixed-sized MAC control elements. The size of the L field may be indicated by the F field and F2 field. The F or the Format field may indicate the size of the Length field. There may be one F field per MAC PDU subheader except for the last subheader and subheaders corresponding to fixed-sized MAC control elements and expect for when F2 is set to 1. The size of the F field may be 1 bit. In an example, if the F field is included, and/or if the size of the MAC SDU or variable-sized MAC control element is less than 128 bytes, the value of the F field is set to 0, otherwise it is set to 1. The F2 or the Format2 field may indicate the size of the Length field. There may be one F2 field per MAC PDU subheader. The size of the F2 field may be 1 bit. In an example, if the size of the MAC SDU or variable-sized MAC control element is larger than 32767 bytes and if the corresponding subheader is not the last subheader, the value of the F2 field may be set to 1, otherwise it is set to 0. The E or the Extension field may be a flag indicating if more fields are present in the MAC header or not. The E field may be set to "1" to indicate another set of at least R/F2/E/LCID fields. The E field may be set to "0" to indicate that either a MAC SDU, a MAC control element or padding starts at the next byte. R or reserved bit, set to "0".

**[0137]** MAC PDU subheaders may have the same order as the corresponding MAC SDUs, MAC control elements and padding. MAC control elements may be placed before any MAC SDU. Padding may occur at the end of the MAC PDU, except when single-byte or two-byte padding is required. Padding may have any value and the MAC entity may ignore it. When padding is performed at the end of the MAC PDU, zero or more padding bytes may be allowed. When single-byte or two-byte padding is required, one or two MAC PDU subheaders corresponding to padding may be placed at the beginning of the MAC PDU before any other MAC PDU subheader. In an example, a maximum of one MAC PDU may be transmitted per TB per MAC entity, a maximum of one MCH MAC PDU can be transmitted per TTI.

**[0138]** At least one RRC message may provide configuration parameters for at least one cell and configuration parameters for PUCCH groups. The information elements in one or more RRC messages may provide mapping between configured cells and PUCCH SCells. Cells may be grouped into a plurality of cell groups and a cell may be assigned to one of the configured PUCCH groups. There may be a one-to-one relationship between PUCCH groups and cells with configured PUCCH resources. At least one RRC message may provide mapping between an SCell and a PUCCH group, and PUCCH configuration on PUCCH SCell.

**[0139]** System information (common parameters) for an SCell may be carried in a RadioResourceConfigCommonSCell in a dedicated RRC message. Some of the PUCCH related information may be included in common information of an SCell (e.g. in the RadioResourceConfigCommonSCell). Dedicated configuration parameters of SCell and PUCCH resources may be configured by dedicated RRC signaling using, for example, RadioResourceConfigDedicatedSCell.

**[0140]** The IE PUCCH-ConfigCommon and IE PUCCH-ConfigDedicated may be used to specify the common and the UE specific PUCCH configuration respectively.

**[0141]** In an example, PUCCH-ConfigCommon may include: deltaPUCCH-Shift: ENUMERATED {ds1, ds2, ds3}; nRB-CQI: INTEGER (0 . . . 98); nCS-AN: INTEGER (0 . . . 7); and/or n1PUCCH-AN: INTEGER (0 . . . 2047). The parameter deltaPUCCH-Shift ( $\Delta_{shift}^{PUCCH}$ ), nRB-CQI ( $N_{RB}^{(2)}$ ), nCS-An ( $N_{cs}^{(1)}$ ), and n1PUCCH-AN ( $N_{PUCCH}^{(1)}$ ) may be physical layer parameters of PUCCH.

**[0142]** PUCCH-ConfigDedicated may be employed. PUCCH-ConfigDedicated may include: ackNackRepetitionCHOICE{release: NULL, setup: SEQUENCE {repetitionFactor: ENUMERATED {n2, n4, n6, spare1}, n1PUCCH-AN-Rep: INTEGER (0 . . . 2047)}}, tdd-AckNackFeedbackMode: ENUMERATED {bundling, multiplexing} OPTIONAL}. ackNackRepetitionj parameter indicates whether ACK/NACK repetition is configured. n2 corresponds to repetition factor 2, n4 to 4 for repetitionFactor parameter ( $N_{ANRep}^{(1,p)}$ ). n1PUCCH-AN-Rep parameter may be  $N_{PUCCH,ANRep}^{(1,p)}$  for antenna port P0 and for antenna port P1. dd-AckNackFeedbackMode parameter may indicate one of the TDD ACK/NACK feedback modes used. The value bundling may correspond to use of ACK/NACK bundling whereas, the value multiplexing may correspond to ACK/NACK multiplexing. The same value may apply to both ACK/NACK feedback modes on PUCCH as well as on PUSCH.

**[0143]** The parameter PUCCH-ConfigDedicated may include simultaneous PUCCH-PUSCH parameter indicating whether simultaneous PUCCH and PUSCH transmissions is configured. An E-UTRAN may configure this field for the PCell when the nonContiguousUL-RA-WithinCC-Info is set to supported in the band on which PCell is configured. The E-UTRAN may configure this field for the PSCell when the nonContiguousUL-RA-WithinCC-Info is set to supported in the band on which PSCell is configured. The E-UTRAN may configure this field for the PUCCH SCell when the nonContiguousUL-RA-WithinCC-Info is set to supported in the band on which PUCCH SCell is configured.

**[0144]** A UE may transmit radio capabilities to an eNB to indicate whether UE support the configuration of PUCCH groups. The simultaneous PUCCH-PUSCH in the UE capability message may be applied to both a PCell and an SCell. Simultaneous PUCCH+PUSCH may be configured separately (using separate IEs) for a PCell and a PUCCH SCell. For example, a PCell and a PUCCH SCell may have different or the same configurations related to simultaneous PUCCH+PUSCH.

**[0145]** The eNB may select the PUCCH SCell among current SCells or candidate SCells considering cell loading, carrier quality (e.g. using measurement reports), carrier configuration, and/or other parameters. From a functionality perspective, a PUCCH Cell group management procedure may include a PUCCH Cell group addition, a PUCCH cell group release, a PUCCH cell group change and/or a PUCCH

cell group reconfiguration. The PUCCH cell group addition procedure may be used to add a secondary PUCCH cell group (e.g., to add PUCCH SCell and one or more SCells in the secondary PUCCH cell group). In an example embodiment, cells may be released and added employing one or more RRC messages. In another example embodiment, cells may be released employing a first RRC message and then added employing a second RRC messages.

**[0146]** SCells including PUCCH SCell may be in a deactivated state when they are configured. A PUCCH SCell may be activated after an RRC configuration procedure by an activation MAC CE. An eNB may transmit a MAC CE activation command to a UE. The UE may activate an SCell in response to receiving the MAC CE activation command

**[0147]** In example embodiments, a timer is running once it is started, until it is stopped or until it expires; otherwise it may not be running. A timer can be started if it is not running or restarted if it is running. For example, a timer may be started or restarted from its initial value.

**[0148]** LTE-Advanced introduced Carrier Aggregation (CA) in Release-10. In Release-10 CA, the Primary Cell (PCell) is always activated. One or more Secondary Cells (SCells) can be in activated or deactivated state. The SCell activation/deactivation processes were introduced in Release-10 to achieve battery power savings. When an SCell is deactivated, the UE may stop receiving downlink signals and stop transmission on the SCell. In Release-10 CA, the default state of an SCell is deactivated when the SCell has been configured/added. Additional activation procedure employing MAC CE Activation Command may be needed to activate the SCell. SCells may be deactivated either by an activation/deactivation MAC CE or by the sCellDeactivation-Timer. The UE and eNB maintain one sCellDeactivation-Timer per SCell with a common value across SCells. eNB maintains the activation/deactivation status of an SCell for a wireless device.

**[0149]** In LTE-Advanced Release-12, Dual Connectivity (DC) was introduced. In DC, UE maintains connectivity to a Master eNB (MeNB) and a Secondary eNB (SeNB). Serving cells may be grouped into cell groups (CGs) such as a master CG (MCG) and a secondary CG (SCG). The primary cell in MeNB is called PCell. A cell in SeNB is called PSCell. A PSCell may support similar functions supported by a PCell, such as PUCCH, RACH, RLM, etc. If PSCell is deactivated, many processes may be impacted in SCG, e.g. RACH and PUCCH delivery. Therefore, in Release-12 DC, PSCell in SCG and PCell in MCG are kept in the activated state. In DC, the activation/deactivation processes may be performed per CG and per eNB. Activation/deactivation related information may not be exchanged between MeNB and SeNB. With DC, the cells with PUCCH (e.g. PCell and PSCell) are always in an activated state after they are configured. This process may prevent the need for cross-eNB activation/deactivation.

**[0150]** Cells of an eNB may be grouped in multiple PUCCH groups, each having its own PUCCH resources on a PUCCH SCell. An eNB configures PUCCH groups for a wireless device by transmitting RRC message(s) to the wireless device. Implementation of activation/deactivation processes for PUCCH SCell may present some issues, if Release-10 or 12 activation/deactivation processes are implemented. For example, it may be needed to implement methods and systems to handle PUCCH transmissions when PUCCH SCell is deactivated and one or more SCells in the corresponding PUCCH group are still active. Novel PUCCH SCell

activation/deactivation procedures may be implemented when PUCCH SCell is configured. In addition, novel PUCCH SCell activation/deactivation procedures may be implemented to handle scenarios wherein PUCCH is deactivated.

**[0151]** PUCCH SCell may include many of the functionalities of the PSCell. Some of the issues related to deactivation of PUCCH SCell may be resolved if PUCCH SCell is always kept active, like, PCell or PSCell in prior releases of LTE-Advanced. Such a solution may increase battery power consumption in the UE since the UE has to always keep PUCCH SCell activated after PUCCH SCell is configured.

**[0152]** Implementation of the same activation and deactivation processes for PUCCH SCell and PSCell in DC may result in an inefficient implementation. To achieve battery power saving benefits similar to the existing CA technology, it may be beneficial to enable deactivation of the PUCCH SCell. PUCCH SCell delivers uplink control information for the serving cells in the corresponding PUCCH cell group using its configured PUCCH resources. When there is no need for PUCCH UCI delivery, e.g. when other serving cells in the same PUCCH cell group are deactivated, the PUCCH SCell may be deactivated. Support for activation/deactivation of PUCCH SCell may provide battery power saving benefits. There may be no need to keep PUCCH SCell activated all the time, for example when there is no data transmission on cells in the corresponding PUCCH group. A PUCCH SCell deactivation procedure may introduce new implications for SCells that are in the corresponding PUCCH group. It may be beneficial to avoid or reduce situations where an active SCell may not have access to an activated PUCCH SCell. It may be beneficial to develop systems and processes wherein the PUCCH SCell may be activated/deactivated to reduce battery power consumption in the UE. Implementations may consider that the PUCCH SCell carries control information related to other SCells within the corresponding PUCCH group.

**[0153]** Solutions may be provided in which PUCCH control information such as HARQ/CQI/SR may be sent on the PUCCH SCell even when the PUCCH SCell is deactivated. Allowing transmission of the PUCCH control information on a deactivated PUCCH SCell may require that PUCCH SCell to be capable of transmitting uplink signals when it is deactivated, or may require activation of PUCCH SCell when such transmissions are needed. Such a solution may be too complex to implement and may require many changes to existing physical and MAC layer procedures and/or hardware. Partially activating the PUCCH SCell for transmission of PUCCH control information may increase power consumption and transceiver complexity and may not be desirable.

**[0154]** Example embodiments of the invention describe solutions that provide efficient systems and processes for PUCCH SCell activation/deactivation process in an LTE network, eNB and UE. The example embodiments provide efficient mechanisms for the network, eNB and UE to implement activation and deactivation processes for SCells. This may require enhancements to existing eNB and UE processes. The embodiments may add additional requirements in eNB and UE implementations and may reduce battery power consumption, without adding too much complexity in eNB and UE implementations.

**[0155]** In an example embodiment of the invention, if the MAC entity is configured with one or more SCells, the network may activate and deactivate the configured SCells. The SpCell may always be activated when it is configured. The

network may activate and deactivate the SCell(s) by sending the Activation/Deactivation MAC control element. Furthermore, the MAC entity may maintain a sCellDeactivation-Timer timer for a configured SCell. The same initial timer value applies to an instance of the sCellDeactivationTimer and it is configured by RRC. The configured SCells may be initially deactivated upon addition and after a handover.

**[0156]** In an example embodiment, when PUCCH SCell is configured by the RRC layer, the initial state of the PUCCH SCell may be a deactivated state. An eNB may activate a PUCCH SCell when it is needed by transmitting a MAC Activation CE. In an example embodiment, when PUCCH SCell is deactivated, PUCCH resource configuration may be kept (and not released). The configuration of the corresponding PUCCH group may be maintained while deactivating PUCCH SCell or other SCells in the PUCCH group. The re-activation of PUCCH transmission after a deactivation may not require additional RRC reconfiguration procedure since RRC Configuration of PUCCH SCell is retained when it is deactivated. In some embodiments, if the TAG including PUCCH SCell is expired, PUCCH may be released and RRC reconfiguration may be needed to reconfigure PUCCH resources on PUCCH SCell.

**[0157]** In an example scenario, there may be one or more activated SCells belonging to the same PUCCH group with PUCCH SCell. Since serving cells in the same PUCCH group may use this PUCCH to deliver uplink control information, once PUCCH SCell is deactivated, the delivery of the uplink control information for other activated serving cells in the corresponding PUCCH group may not be possible. PUCCH SCell may carry PUCCH for other SCells in a secondary PUCCH group. Other SCells in the secondary PUCCH cell group may require PUCCH SCell resources. eNB implementation may consider that a PUCCH SCell is activated before any other SCell in a secondary PUCCH cell group is activated. The PUCCH SCell may not be de-activated earlier than the other SCells in Secondary PUCCH group. It may be beneficial to keep the PUCCH SCell in the activated state as long as there is at least one other activated SCell in the corresponding PUCCH group.

**[0158]** In an example embodiment, the following processes may be implemented in the UE and/or eNB when an SCell (e.g. PUCCH SCell or other SCells in a PUCCH cell group) is deactivated. Signals are applied to the process if they are configured. Other similar processes may be developed to achieve substantially the same outcome. If an SCell is deactivated, a UE may not transmit SRS on the SCell; may not report CQI/PMI/RI/PTI for the SCell; may not transmit on UL-SCH on the SCell; may not transmit on RACH on the SCell; may not monitor the PDCCH on the SCell; and/or may not monitor the PDCCH for the SCell. HARQ feedback for the MAC PDU containing Activation/Deactivation MAC control element may not be impacted by PCell interruption due to SCell activation/deactivation. When an SCell is deactivated, an ongoing Random Access procedure on the SCell, if any, may be aborted.

**[0159]** If the deactivated SCell is a PUCCH SCell in a PUCCH cell group, in addition to the above processes applicable to SCell deactivation, the UE may implement one or more additional mechanisms. The UE may stop transmission of channel state information for a first secondary cell in the secondary PUCCH cell group, the first secondary cell being different from the PUCCH secondary cell. The UE may stop

receiving downlink shared channel transport blocks on the first secondary cell in the secondary PUCCH cell group.

**[0160]** The UE may clear configured downlink shared channel assignments received for any SCell in the corresponding PUCCH cell group. In an example embodiment, the UE may not be able to process received downlink shared channel packets since the corresponding PUCCH may not be available for HARQ feedback (PUCCH SCell is deactivated). For example, the UE may clear HARQ processes for downlink SCH transport blocks in the corresponding PUCCH cell group. In an example, UE may flush HARQ processes for downlink shared channel transport blocks on the first secondary cell in the secondary PUCCH cell group.

**[0161]** In an example embodiment, the UE may stop processing assignments for downlink shared channel transport blocks received for/on the first secondary cell in the secondary PUCCH cell group. In an example, the UE may stop monitoring the PDCCH downlink assignments on the first secondary cell and may stop monitoring the PDCCH downlink assignments for the first secondary cell. The first secondary cell is an activated cell in the secondary PUCCH cell group, wherein the secondary PUCCH cell is deactivated. In an example, the UE may stop monitoring the PDCCH downlink assignments for downlink shared channel transport blocks on the first secondary cell and may stop monitoring the PDCCH downlink assignments for downlink shared channel transport blocks for the first secondary cell. The first secondary cell is an activated cell in the secondary PUCCH cell group, wherein the secondary PUCCH cell is deactivated.

**[0162]** The UE may stop transmission of PUCCH on the PUCCH SCell for SCells in the corresponding PUCCH cell group. In an example embodiment, UE may continue receiving uplink grants comprising uplink radio resources for transmission of an uplink transport block on the first secondary cell in the secondary PUCCH cell group. The UE may transmit the uplink transport block on the first secondary cell. The UE may continue transmission of sounding reference signals on the first secondary cell in the secondary PUCCH cell group. UE may transmit uplink transport blocks and SRS in other serving cells of the PUCCH cell group when PUCCH SCell is deactivated.

**[0163]** In the example embodiments, if the MAC entity receives an Activation/Deactivation MAC control element in a TTI activating the SCell (e.g. PUCCH SCell or other SCell (s) in a PUCCH cell group), the MAC entity may activate the SCell. When an SCell is activated, UE may apply normal SCell operation including one or more or all of the following: SRS transmissions on the SCell, PDCCH monitoring on the SCell, PDCCH monitoring for the SCell, start or restart the sCellDeactivationTimer associated with the SCell, and/or trigger PHR. When an SCell is activated, UE may apply CQI/PMI/RI/PTI/HARQ reporting for the SCell, if the corresponding PUCCH is activated and uplink synchronized (is included in an uplink synchronized TAG).

**[0164]** If the SCell belong to primary PUCCH cell group, then PUCCH is always activated. If the SCell is in a secondary PUCCH cell group, UE may apply CQI/PMI/RI/PTI/HARQ reporting for the SCell, if the corresponding PUCCH SCell is active and uplink synchronized. In an example embodiment, when a PUCCH SCell is activated, the UE may apply normal operation of PUCCH transmissions. SRS and/or PUCCH are transmitted on an activated SCell if SRS and/or PUCCH are configured on the SCell. No uplink signals such as PUCCH, PUSCH, and SRS signals may be transmitted on an SCell

which is out-of-sync (included in an out-of-sync TAG), except random access preamble.

**[0165]** A PUCCH SCell may be activated or deactivated by Activation/Deactivation MAC control element like other SCell(s) configured by an eNB. eNB implementation may activate a PUCCH SCell before any other SCell in the corresponding PUCCH cell group is activated. In an example embodiment, if an eNB activates an SCell in a secondary PUCCH cell group when the corresponding PUCCH SCell is deactivated, the UE may not report CQI/PMI/RI/PTI/HARQ on PUCCH for the SCell until the corresponding PUCCH SCell is activated and uplink synchronized.

**[0166]** In an example embodiment, if the MAC entity in a UE receives a Deactivation MAC control element, the UE may deactivate the SCell. A PUCCH SCell may be deactivated by Deactivation MAC control element regardless of activation or deactivation status of other SCells in the corresponding PUCCH cell group. It may be up to eNB implementation to decide when to transmit Activation/Deactivation MAC control elements to a UE. A UE may process the received command to activate or deactivate SCells per the Activation/Deactivation MAC control element.

**[0167]** When the PUCCH SCell in a PUCCH cell group is in the deactivated state, the PUCCH SCell may not transmit PUCCH control information in the uplink PUCCH for the SCells in the corresponding PUCCH cell group. Other activated SCell(s) in a PUCCH cell group corresponding to a deactivated PUCCH SCell may not transmit uplink CQI/PMI/RI/PTI/HARQ-feedback reporting on PUCCH of the deactivated PUCCH SCell. In an example embodiment, in such a scenario, UE may be able to receive uplink grants and transmit uplink packets to the eNB, but may stop receiving DL-SCH packets. UE may be able to receive downlink HARQ and downlink physical control channels (e.g. PBCCH, PCFICH, PDCCCH, and/or ePDCCCH) and/or broadcast channel (e.g. MCH, and/or MBSFN subframes, etc) on the SCell. UE may not be able to provide downlink feedback information (e.g. CQI/PMI/RI/PTI/HARQ-feedback) on a deactivated PUCCH SCell.

**[0168]** In an example embodiment, when PUCCH SCell is deactivated, UE may clear any configured downlink assignments received for the SCells in the corresponding PUCCH cell group. UE may clear any HARQ processes for downlink packets in the corresponding PUCCH cell group.

**[0169]** eNB implementation may reduce or prevent scenarios wherein PUCCH SCell is deactivated while one or more other SCells in the corresponding PUCCH cell group are active. For example, eNB may transmit activation command for activating PUCCH SCell before or at the same time activating other SCells in the corresponding PUCCH cell group. For example, an eNB may not transmit a deactivation command to deactivate PUCCH SCell, when there is at least one active SCell in the corresponding PUCCH cell group.

**[0170]** In an example embodiment, MCH transmission may occur in subframes configured by upper layer for MCCH or MTCH transmission. For such subframe, upper layer may indicate if signallingMCS or dataMCS applies. The transmission of an MCH may occur in a set of subframes defined by PMCH-Config. An MCH Scheduling Information MAC control element may be included in the first subframe allocated to the MCH within the MCH scheduling period to indicate the position of each MTCH and unused subframes on the MCH. In an example embodiment, the MAC entity may assume that the first scheduled MTCH starts after (e.g. immediately after)

the MCCH or the MCH Scheduling Information MAC control element if the MCCH is not present, and the other scheduled MTCH(s) start after (e.g. immediately after) the previous MTCH, at the earliest in the subframe where the previous MTCH stops. When the MAC entity needs to receive MCH, the MAC entity may: attempt to decode the TB on the MCH; if a TB on the MCH has been successfully decoded: demultiplex the MAC PDU and deliver the MAC SDU(s) to upper layers.

**[0171]** When a PUCCH SCell is deactivated, the UE may receive MB SFN subframes and broadcast/multicast transport blocks in the downlink for one or more SCells in the corresponding PUCCH cell group. MBSFN subframes configuration parameters indicating MBSFN subframes may be configured by system information broadcasted by eNB and/or RRC message(s). The UE may continue processing of the received broadcast/multicast control and data packets (e.g. transport blocks) and other broadcast information.

**[0172]** FIG. 14 is an example flow diagram as per an aspect of an embodiment of the present invention. A wireless device receives at least one message from a base station at 1410. The message(s) may comprise configuration parameters of a plurality of cells. The plurality of cells may comprise secondary cell(s). The plurality of cells may be grouped into a plurality of physical uplink control channel (PUCCH) groups. The PUCCH groups may comprise a primary PUCCH group and/or a secondary PUCCH group. The primary PUCCH group may comprise a primary cell with a primary PUCCH transmitted to the base station. The secondary PUCCH group may comprise a PUCCH secondary cell with a secondary PUCCH transmitted to the base station. The message(s) may also comprise a deactivation timer value for a deactivation timer of one or more secondary cells.

**[0173]** The PUCCH secondary cell may be deactivated after a deactivation condition for the PUCCH secondary cell is met at 1420. Configuration of PUCCH resources of the PUCCH secondary cell may be maintained when the PUCCH secondary cell is deactivated.

**[0174]** Transmission of channel state information for a first secondary cell in the secondary PUCCH group may be stopped at 1430 after deactivation of the PUCCH secondary cell. The first secondary cell may be different from the PUCCH secondary cell.

**[0175]** Transmission of positive acknowledgement and negative acknowledgement on the PUCCH secondary cell may be stopped at 1440 after deactivation of the PUCCH secondary cell.

**[0176]** According to an embodiment, the wireless device may stop receiving downlink shared channel transport blocks on the first secondary cell. According to an embodiment, the wireless device may also continue receiving uplink grants comprising uplink radio resource parameters for transmission of an uplink transport block on the first secondary cell and/or transmit the uplink transport block on the first secondary cell. According to an embodiment, the wireless device may continue transmission of sounding reference signals on the first secondary cell. According to an embodiment, the wireless device may flush downlink HARQ buffers and/or downlink HARQ processes for the first secondary cell after deactivation of the PUCCH secondary cell. According to an embodiment, a deactivation timer of the PUCCH secondary cell may be disabled.

**[0177]** FIG. 15 is an example flow diagram as per an aspect of an embodiment of the present invention. A base station

may transmit at least one message to a wireless device at **1510**. The message(s) may comprise configuration parameters of a plurality of cells. The configuration parameters may comprise secondary cell(s). The plurality of cells may be grouped into a plurality of physical uplink control channel (PUCCH) groups. The PUCCH groups may comprise a primary PUCCH group and/or a secondary PUCCH group. The primary PUCCH group may comprise a primary cell with a primary PUCCH transmitted to the base station. The secondary PUCCH group may comprise a PUCCH secondary cell with a secondary PUCCH transmitted to the base station. The message(s) may also comprise a deactivation timer value for a deactivation timer of one or more secondary cells.

**[0178]** A state of the PUCCH secondary cell for the wireless device may be deactivated at **1520** after a deactivation condition for the PUCCH secondary cell is met. Reception, from the wireless device, of channel state information for a first secondary cell in the secondary PUCCH group may be stopped at **1530** after deactivation of the PUCCH secondary cell. The first secondary cell may be different from the PUCCH secondary cell.

**[0179]** Reception of positive acknowledgement and negative acknowledgement on the PUCCH secondary cell from the wireless device may be stopped at **1540** after deactivation of the PUCCH secondary cell.

**[0180]** According to an embodiment, the transmission of downlink shared channel transport blocks to the wireless device on the first secondary cell may be stopped. According to an embodiment, transmission, to the wireless device, of uplink grants may be continued. The uplink grants may comprise uplink radio resource parameters for transmission of an uplink transport block on the first secondary cell. Additionally, the uplink transport block may be received on the first secondary cell.

**[0181]** According to an embodiment, the base station may continue to receive, from the wireless device, sounding reference signals on the first secondary cell. According to an embodiment, the base station may transmit a MAC deactivation command from the base station indicating deactivation of the PUCCH secondary cell. According to an embodiment, a deactivation timer of the PUCCH secondary cell for the wireless device may be disabled. According to an embodiment, configuration of PUCCH resources of the PUCCH secondary cell may be maintained when the PUCCH secondary cell is deactivated.

**[0182]** The Primary PUCCH group may comprise a group of serving cells including a PCell whose PUCCH signalling is associated with the PUCCH on PCell. A PUCCH group may comprise either primary PUCCH group or a secondary PUCCH group. A PUCCH SCell may comprise a secondary cell configured with PUCCH. A Secondary PUCCH group may comprise a group of SCells whose PUCCH signalling is associated with the PUCCH on the PUCCH SCell.

**[0183]** A PUCCH may be transmitted on a PCell, a PUCCH SCell (if such is configured in CA) and/or on a PSCell (in DC).

**[0184]** With regard to carrier aggregation, the configured set of serving cells for a UE may comprise of one PCell and one or more SCells. If DC is not configured, one additional PUCCH may be configured on an SCell, such as, for example, the PUCCH SCell. When a PUCCH SCell is configured, an RRC may configure the mapping of each serving cell to a Primary PUCCH group or a Secondary PUCCH group (e.g.,

for each SCell, whether the PCell or the PUCCH SCell is used for the transmission of ACK/NAKs and/or CSI reports).

**[0185]** With regard to activation/deactivation Mechanism (s), an E-UTRAN may ensure that while a PUCCH SCell is deactivated, SCells of a secondary PUCCH group should not be activated. With the exception of a PUCCH SCell, one deactivation timer may be maintained per SCell. One common value may be configured per CG by RRC.

**[0186]** FIG. 16 is an example flow diagram as per an aspect of an embodiment of the present invention. A wireless device receives at least one message from a base station at **1610**. The message(s) may comprise configuration parameters of a plurality of cells. The plurality of cells may be grouped into a plurality of physical uplink control channel (PUCCH) groups. The PUCCH groups may comprise a primary PUCCH group and/or a secondary PUCCH group. The primary PUCCH group may comprise a primary cell with a primary PUCCH transmitted to the base station. The secondary PUCCH group may comprise a PUCCH secondary cell with a secondary PUCCH transmitted to the base station.

**[0187]** At **1620**, the PUCCH secondary cell may be deactivated after a deactivation condition for the PUCCH secondary cell is met. At **1630**, the wireless device may stop receiving downlink shared channel transport blocks on a first secondary cell in the secondary PUCCH group after deactivation of the PUCCH secondary cell. The first secondary cell may be different from the PUCCH secondary cell. The wireless device may continue to receive downlink multicast channel transport blocks on the first secondary cell at **1640**.

**[0188]** According to an embodiment, the wireless device may stop transmission of positive acknowledgement and negative acknowledgement on the PUCCH secondary cell after deactivation of the PUCCH secondary cell.

**[0189]** According to an embodiment, the wireless device may continue receiving uplink grants comprising uplink radio resource parameters for transmission of an uplink transport block on the first secondary cell. Additionally, the wireless device may transmit the uplink transport block on the first secondary cell.

**[0190]** According to an embodiment, the wireless device may continue transmission of sounding reference signals on the first secondary cell. According to an embodiment, the wireless device may receive a MAC deactivation command from the base station indicating deactivation of the PUCCH secondary cell. A deactivation timer of the PUCCH secondary cell may be disabled. According to an embodiment, the wireless device may maintain configuration of PUCCH resources of the PUCCH secondary cell when the PUCCH secondary cell is deactivated.

**[0191]** FIG. 17 is an example flow diagram as per an aspect of an embodiment of the present invention. A base station may transmit at least one message to a wireless device at **1710**. The message(s) may comprise configuration parameters of a plurality of cells. The configuration parameters may comprise secondary cell(s). The plurality of cells may be grouped into a plurality of physical uplink control channel (PUCCH) groups. The PUCCH groups may comprise a primary PUCCH group and/or a secondary PUCCH group. The primary PUCCH group may comprise a primary cell with a primary PUCCH transmitted to the base station. The secondary PUCCH group may comprise a PUCCH secondary cell with a secondary PUCCH transmitted to the base station.

**[0192]** A state of the PUCCH secondary cell for the wireless device may be deactivated after a deactivation condition

for the PUCCH secondary cell is met at 1720. At 1730, the base station may stop transmitting, to the wireless device, downlink shared channel transport blocks on a first secondary cell in the secondary PUCCH group after deactivation of the PUCCH secondary cell. The first secondary cell may be different from the PUCCH secondary cell. At 1740, the base station may continue transmitting downlink multicast channel transport blocks on the first secondary cell.

[0193] According to an embodiment, the base station may stop reception of positive acknowledgement and negative acknowledgement on the PUCCH secondary cell after deactivation of the PUCCH secondary cell.

[0194] According to an embodiment, the base station may continue transmitting, to the wireless device, uplink grants comprising uplink radio resource parameters for transmission of an uplink transport block on the first secondary cell. Additionally, the base station may receive the uplink transport block on the first secondary cell.

[0195] According to an embodiment, the base station may continue receiving, from the wireless device, sounding reference signals on the first secondary cell. According to an embodiment, the base station may transmit a MAC deactivation command from the base station indicating deactivation of the PUCCH secondary cell. According to an embodiment, a deactivation timer of the PUCCH secondary cell for the wireless device is disabled. According to an embodiment, the base station may maintain configuration of PUCCH resources of the PUCCH secondary cell, when the PUCCH secondary cell is deactivated.

[0196] In this specification, “a” and “an” and similar phrases are to be interpreted as “at least one” and “one or more.” In this specification, the term “may” is to be interpreted as “may, for example.” In other words, the term “may” is indicative that the phrase following the term “may” is an example of one of a multitude of suitable possibilities that may, or may not, be employed to one or more of the various embodiments. If A and B are sets and every element of A is also an element of B, A is called a subset of B. In this specification, only non-empty sets and subsets are considered. For example, possible subsets of  $B = \{\text{cell1}, \text{cell2}\}$  are:  $\{\text{cell1}\}$ ,  $\{\text{cell2}\}$ , and  $\{\text{cell1}, \text{cell2}\}$ .

[0197] In this specification, parameters (Information elements: IEs) may comprise one or more objects, and each of those objects may comprise one or more other objects. For example, if parameter (IE) N comprises parameter (IE) M, and parameter (IE) M comprises parameter (IE) K, and parameter (IE) K comprises parameter (information element) J, then, for example, N comprises K, and N comprises J. In an example embodiment, when one or more messages comprise a plurality of parameters, it implies that a parameter in the plurality of parameters is in at least one of the one or more messages, but does not have to be in each of the one or more messages.

[0198] Many of the elements described in the disclosed embodiments may be implemented as modules. A module is defined here as an isolatable element that performs a defined function and has a defined interface to other elements. The modules described in this disclosure may be implemented in hardware, software in combination with hardware, firmware, wetware (i.e. hardware with a biological element) or a combination thereof, all of which are behaviorally equivalent. For example, modules may be implemented as a software routine written in a computer language configured to be executed by a hardware machine (such as C, C++, Fortran, Java, Basic,

Matlab or the like) or a modeling/simulation program such as Simulink, Stateflow, GNU Octave, or LabVIEWMathScript. Additionally, it may be possible to implement modules using physical hardware that incorporates discrete or programmable analog, digital and/or quantum hardware. Examples of programmable hardware comprise: computers, microcontrollers, microprocessors, application-specific integrated circuits (ASICs); field programmable gate arrays (FPGAs); and complex programmable logic devices (CPLDs). Computers, microcontrollers and microprocessors are programmed using languages such as assembly, C, C++ or the like. FPGAs, ASICs and CPLDs are often programmed using hardware description languages (HDL) such as VHSIC hardware description language (VHDL) or Verilog that configure connections between internal hardware modules with lesser functionality on a programmable device. Finally, it needs to be emphasized that the above mentioned technologies are often used in combination to achieve the result of a functional module.

[0199] The disclosure of this patent document incorporates material which is subject to copyright protection. The copyright owner has no objection to the facsimile reproduction by anyone of the patent document or the patent disclosure, as it appears in the Patent and Trademark Office patent file or records, for the limited purposes required by law, but otherwise reserves all copyright rights whatsoever.

[0200] While various embodiments have been described above, it should be understood that they have been presented by way of example, and not limitation. It will be apparent to persons skilled in the relevant art(s) that various changes in form and detail can be made therein without departing from the spirit and scope. In fact, after reading the above description, it will be apparent to one skilled in the relevant art(s) how to implement alternative embodiments. Thus, the present embodiments should not be limited by any of the above described exemplary embodiments. In particular, it should be noted that, for example purposes, the above explanation has focused on the example(s) using FDD communication systems. However, one skilled in the art will recognize that embodiments of the invention may also be implemented in a system comprising one or more TDD cells (e.g. frame structure 2 and/or frame structure 3-licensed assisted access). The disclosed methods and systems may be implemented in wireless or wireline systems. The features of various embodiments presented in this invention may be combined. One or many features (method or system) of one embodiment may be implemented in other embodiments. Only a limited number of example combinations are shown to indicate to one skilled in the art the possibility of features that may be combined in various embodiments to create enhanced transmission and reception systems and methods.

[0201] In addition, it should be understood that any figures which highlight the functionality and advantages, are presented for example purposes only. The disclosed architecture is sufficiently flexible and configurable, such that it may be utilized in ways other than that shown. For example, the actions listed in any flowchart may be re-ordered or only optionally used in some embodiments.

[0202] Further, the purpose of the Abstract of the Disclosure is to enable the U.S. Patent and Trademark Office and the public generally, and especially the scientists, engineers and practitioners in the art who are not familiar with patent or legal terms or phraseology, to determine quickly from a cursory inspection the nature and essence of the technical dis-



closure of the application. The Abstract of the Disclosure is not intended to be limiting as to the scope in any way.

**[0203]** Finally, it is the applicant's intent that only claims that include the express language "means for" or "step for" be interpreted under 35 U.S.C. 112, paragraph 6. Claims that do not expressly include the phrase "means for" or "step for" are not to be interpreted under 35 U.S.C. 112.

What is claimed is:

1. A method comprising:
  - receiving, by a wireless device from a base station, at least one message comprising:
    - configuration parameters of a plurality of cells comprising at least one secondary cell, the plurality of cells grouped into a plurality of physical uplink control channel (PUCCH) groups comprising:
      - a primary PUCCH group comprising a primary cell with a primary PUCCH transmitted to the base station; and
      - a secondary PUCCH group comprising a PUCCH secondary cell with a secondary PUCCH transmitted to the base station; and
    - a deactivation timer value for a deactivation timer of one or more secondary cells;
  - deactivating the PUCCH secondary cell after a deactivation condition for the PUCCH secondary cell is met;
  - stopping transmission of channel state information for a first secondary cell in the secondary PUCCH group after deactivation of the PUCCH secondary cell, wherein the first secondary cell is different from the PUCCH secondary cell; and
  - stopping transmission of positive acknowledgement and negative acknowledgement on the PUCCH secondary cell after deactivation of the PUCCH secondary cell.
2. The method of claim 1, further comprising stopping receiving downlink shared channel transport blocks on the first secondary cell.
3. The method of claim 1, further comprising:
  - continuing receiving uplink grants comprising uplink radio resource parameters for transmission of an uplink transport block on the first secondary cell; and
  - transmitting the uplink transport block on the first secondary cell.
4. The method of claim 1, further comprising continuing transmission of sounding reference signals on the first secondary cell.
5. A method of claim 1, further comprising flushing downlink HARQ buffers or downlink HARQ processes for the first secondary cell after deactivation of the PUCCH secondary cell.
6. A method of claim 1, wherein a deactivation timer of the PUCCH secondary cell is disabled.
7. A method of claim 1, further comprising maintaining configuration of PUCCH resources of the PUCCH secondary cell when the PUCCH secondary cell is deactivated.
8. A method comprising:
  - transmitting, by a base station to a wireless device, at least one message comprising:
    - configuration parameters of a plurality of cells comprising at least one secondary cell, the plurality of cells grouped into a plurality of physical uplink control channel (PUCCH) groups comprising:
      - a primary PUCCH group comprising a primary cell with a primary PUCCH received by the base station; and

- a secondary PUCCH group comprising a PUCCH secondary cell with a secondary PUCCH received by the base station; and
    - a deactivation timer value for a deactivation timer of one or more secondary cells; and
  - deactivating a state of the PUCCH secondary cell for the wireless device after a deactivation condition for the PUCCH secondary cell is met;
  - stopping reception, from the wireless device, of channel state information for a first secondary cell in the secondary PUCCH group after deactivation of the PUCCH secondary cell, wherein the first secondary cell is different from the PUCCH secondary cell; and
  - stopping reception of positive acknowledgement and negative acknowledgement on the PUCCH secondary cell from the wireless device after deactivation of the PUCCH secondary cell.
9. The method of claim 8, further comprising stopping transmitting downlink shared channel transport blocks to the wireless device on the first secondary cell.
10. The method of claim 8, further comprising:
  - continuing transmitting, to the wireless device, uplink grants comprising uplink radio resource parameters for transmission of an uplink transport block on the first secondary cell; and
  - receiving the uplink transport block on the first secondary cell.
11. The method of claim 8, further comprising continuing receiving, from the wireless device, sounding reference signals on the first secondary cell.
12. A method of claim 8, further comprising transmitting a MAC deactivation command from the base station indicating deactivation of the PUCCH secondary cell.
13. A method of claim 8, wherein a deactivation timer of the PUCCH secondary cell for the wireless device is disabled.
14. A method of claim 8, further comprising maintaining configuration of PUCCH resources of the PUCCH secondary cell when the PUCCH secondary cell is deactivated.
15. A wireless device comprising:
  - one or more processors; and
  - memory storing instructions that, when executed, cause the wireless device to:
    - receive, from a base station, at least one message comprising:
      - configuration parameters of a plurality of cells comprising at least one secondary cell, the plurality of cells grouped into a plurality of physical uplink control channel (PUCCH) groups comprising:
        - a primary PUCCH group comprising a primary cell with a primary PUCCH transmitted to the base station; and
        - a secondary PUCCH group comprising a PUCCH secondary cell with a secondary PUCCH transmitted to the base station; and
      - a deactivation timer value for a deactivation timer of one or more secondary cells;
    - deactivate the PUCCH secondary cell after a deactivation condition for the PUCCH secondary cell is met;
    - stop transmission of channel state information for a first secondary cell in the secondary PUCCH group after deactivation of the PUCCH secondary cell, wherein the first secondary cell is different from the PUCCH secondary cell; and



stop transmission of positive acknowledgement and negative acknowledgement on the PUCCH secondary cell after deactivation of the PUCCH secondary cell.

**16.** The wireless device of claim **15**, wherein the instructions, when executed, further cause the wireless device to stop receiving downlink shared channel transport blocks on the first secondary cell.

**17.** The wireless device of claim **15**, wherein the instructions, when executed, further cause the wireless device to:  
continue receiving uplink grants comprising uplink radio resource parameters for transmission of an uplink transport block on the first secondary cell; and  
transmit the uplink transport block on the first secondary cell.

**18.** The wireless device of claim **15**, wherein the instructions, when executed, further cause the wireless device to continue transmission of sounding reference signals on the first secondary cell.

**19.** A wireless device of claim **15**, wherein the instructions, when executed, further cause the wireless device to receive a MAC deactivation command from the base station indicating deactivation of the PUCCH secondary cell.

**20.** A wireless device of claim **15**, wherein a deactivation timer of the PUCCH secondary cell is disabled.

\* \* \* \* \*