



US 20170223675A1

(19) **United States**

(12) **Patent Application Publication**
Dinan et al.

(10) **Pub. No.: US 2017/0223675 A1**

(43) **Pub. Date: Aug. 3, 2017**

(54) **DOWNLINK CONTROL INFORMATION IN A WIRELESS DEVICE AND WIRELESS NETWORK**

Publication Classification

(71) Applicant: **Ofinno Technologies, LLC**, Herndon, VA (US)

(51) **Int. Cl.**
H04W 72/04 (2006.01)
H04W 72/10 (2006.01)
H04W 28/26 (2006.01)
H04L 5/00 (2006.01)

(72) Inventors: **Esmael Hejazi Dinan**, Herndon, VA (US); **Alireza Babaei**, Asburn, VA (US)

(52) **U.S. Cl.**
CPC *H04W 72/042* (2013.01); *H04L 5/005* (2013.01); *H04W 72/10* (2013.01); *H04W 28/26* (2013.01)

(73) Assignee: **Ofinno Technologies, LLC**, Herndon, VA (US)

(21) Appl. No.: **15/418,924**

(22) Filed: **Jan. 30, 2017**

Related U.S. Application Data

(60) Provisional application No. 62/289,949, filed on Feb. 2, 2016, provisional application No. 62/290,738, filed on Feb. 3, 2016.

(57) **ABSTRACT**

A wireless device receives a downlink control information (DCI) comprising SRS request field indicating whether an SRS is transmitted in the last symbol of the subframe; and an ending symbol field for a physical uplink shared channel (PUSCH) indicating whether the PUSCH is transmitted in a last symbol of the subframe. The wireless device transmits, in the subframe, one or more transport blocks based on the ending symbol field. The wireless device transmits the SRS signal in the last symbol of the subframe when the SRS request field indicates that SRS transmission is triggered.

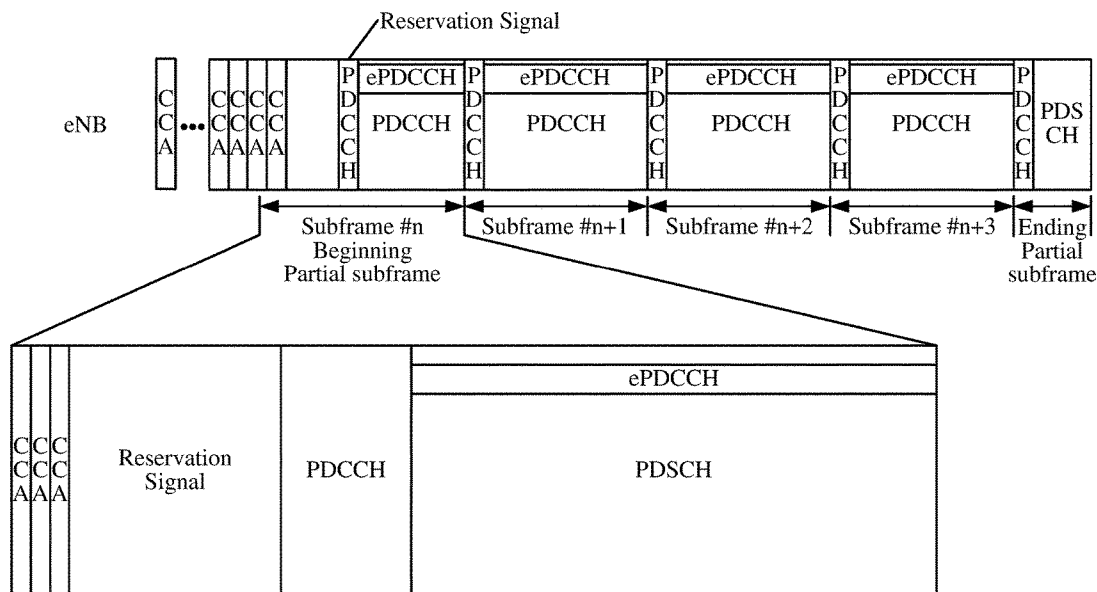

DL transmission

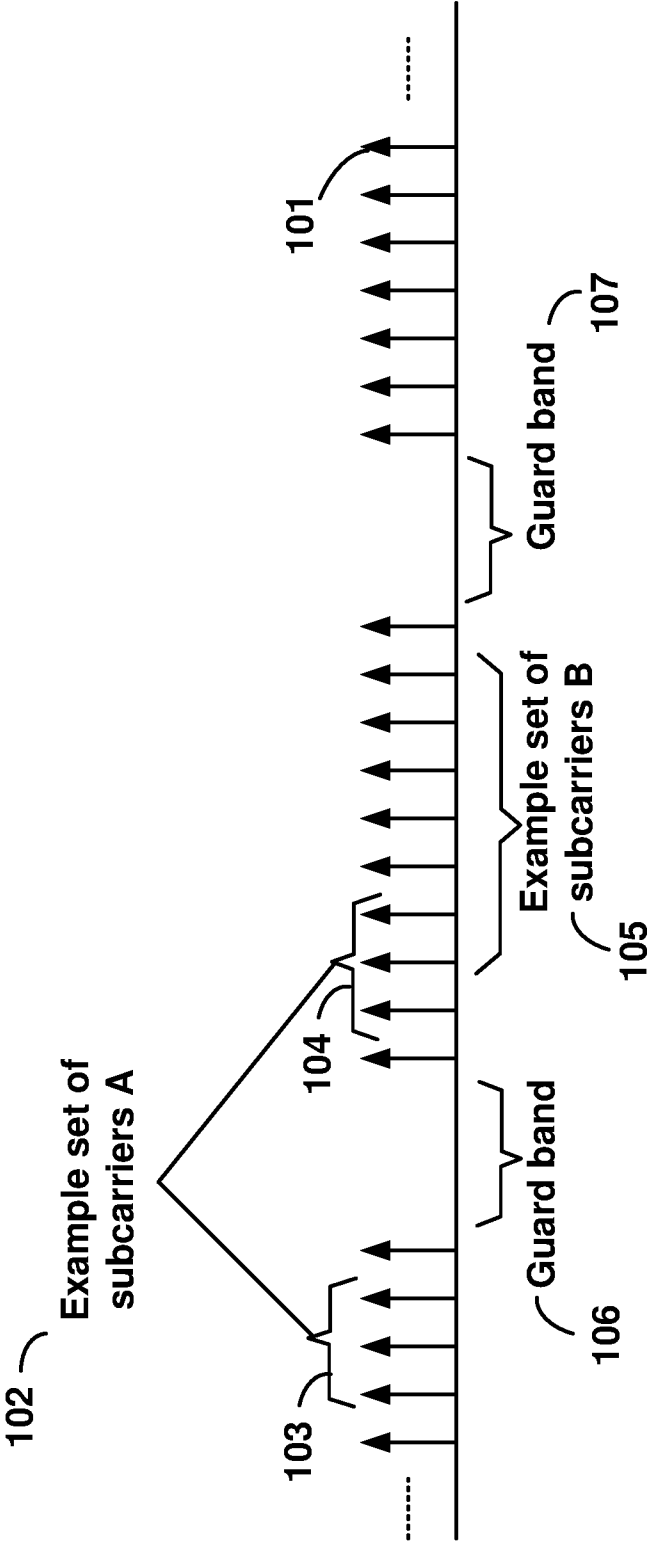

FIG. 1

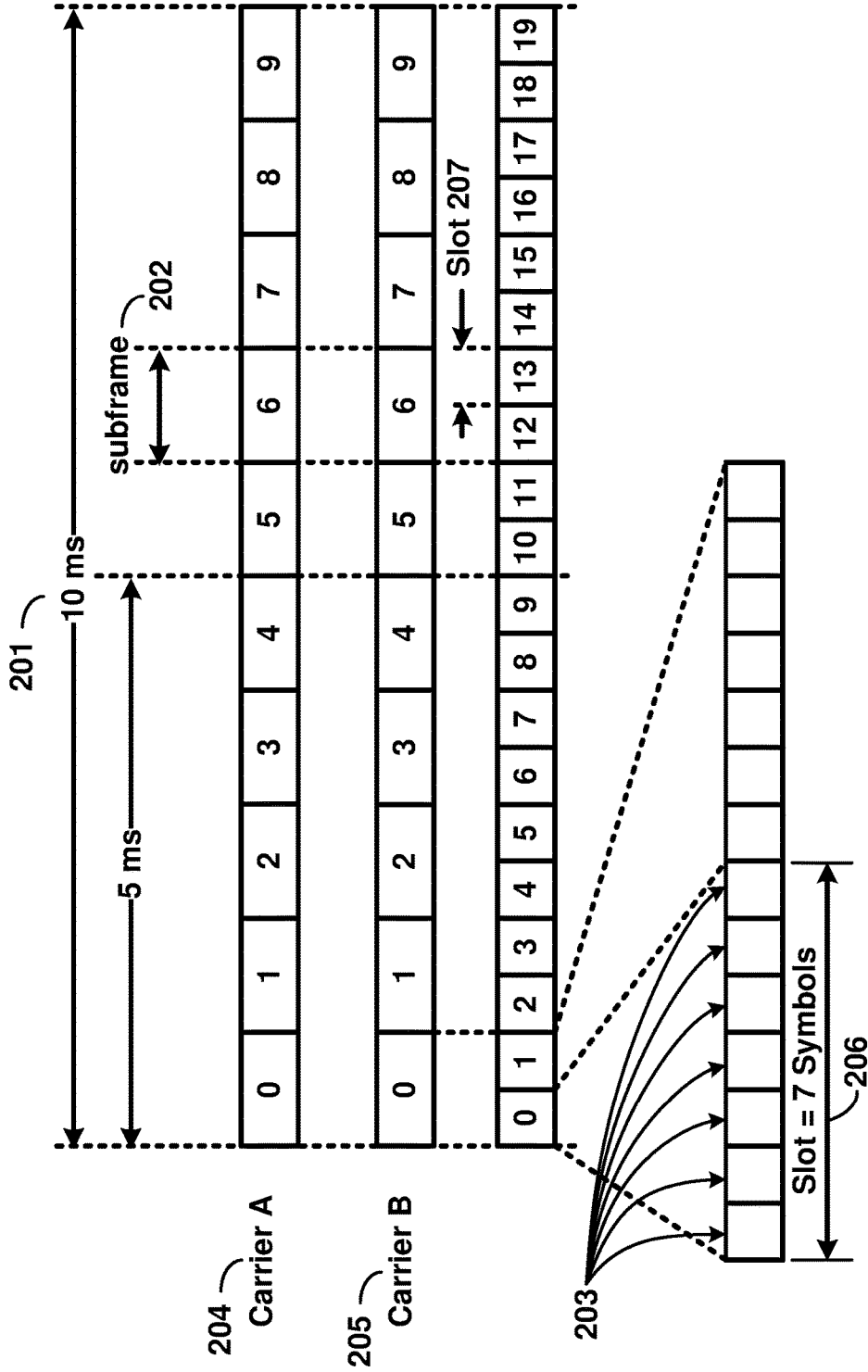

FIG. 2

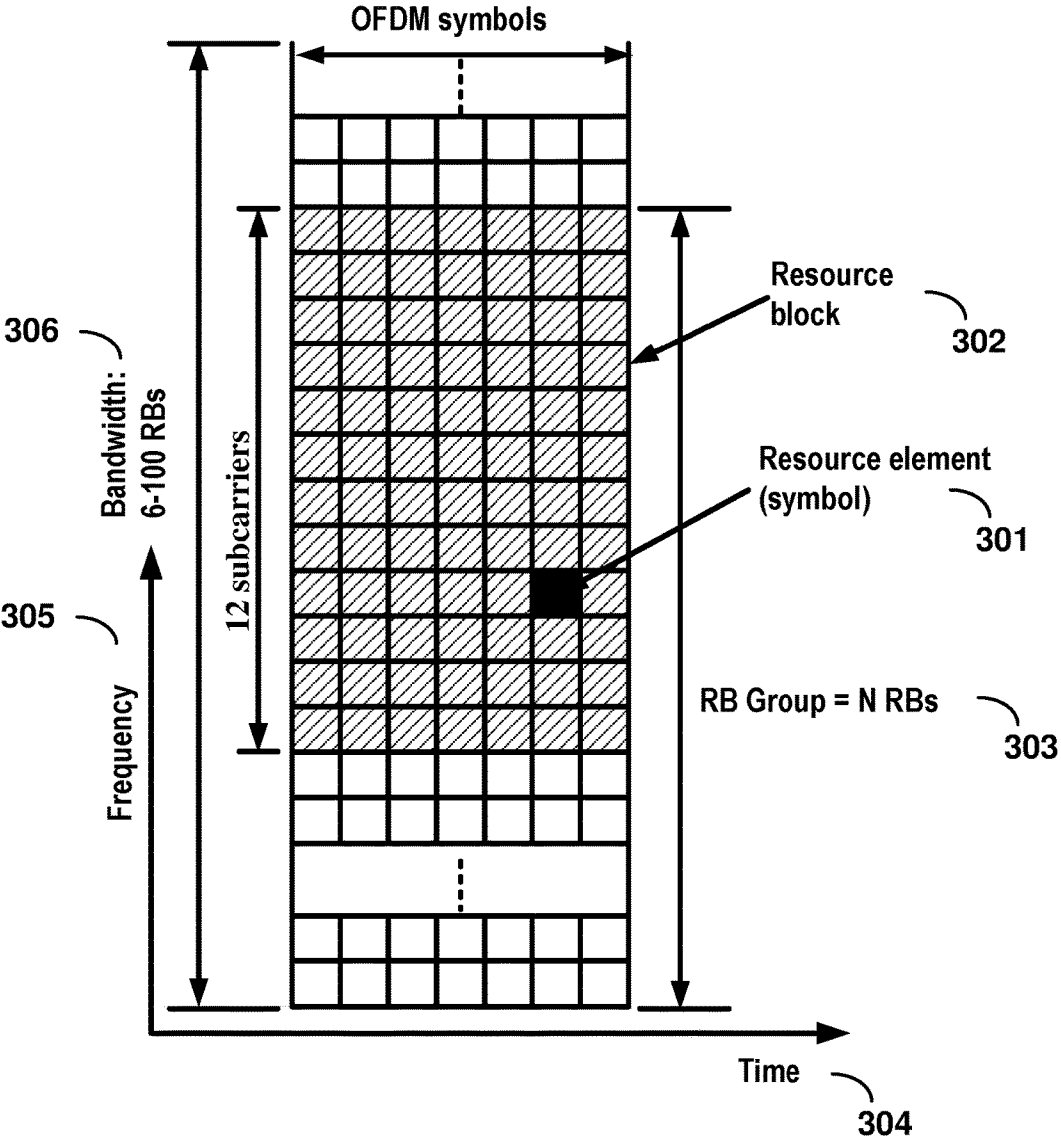

FIG. 3

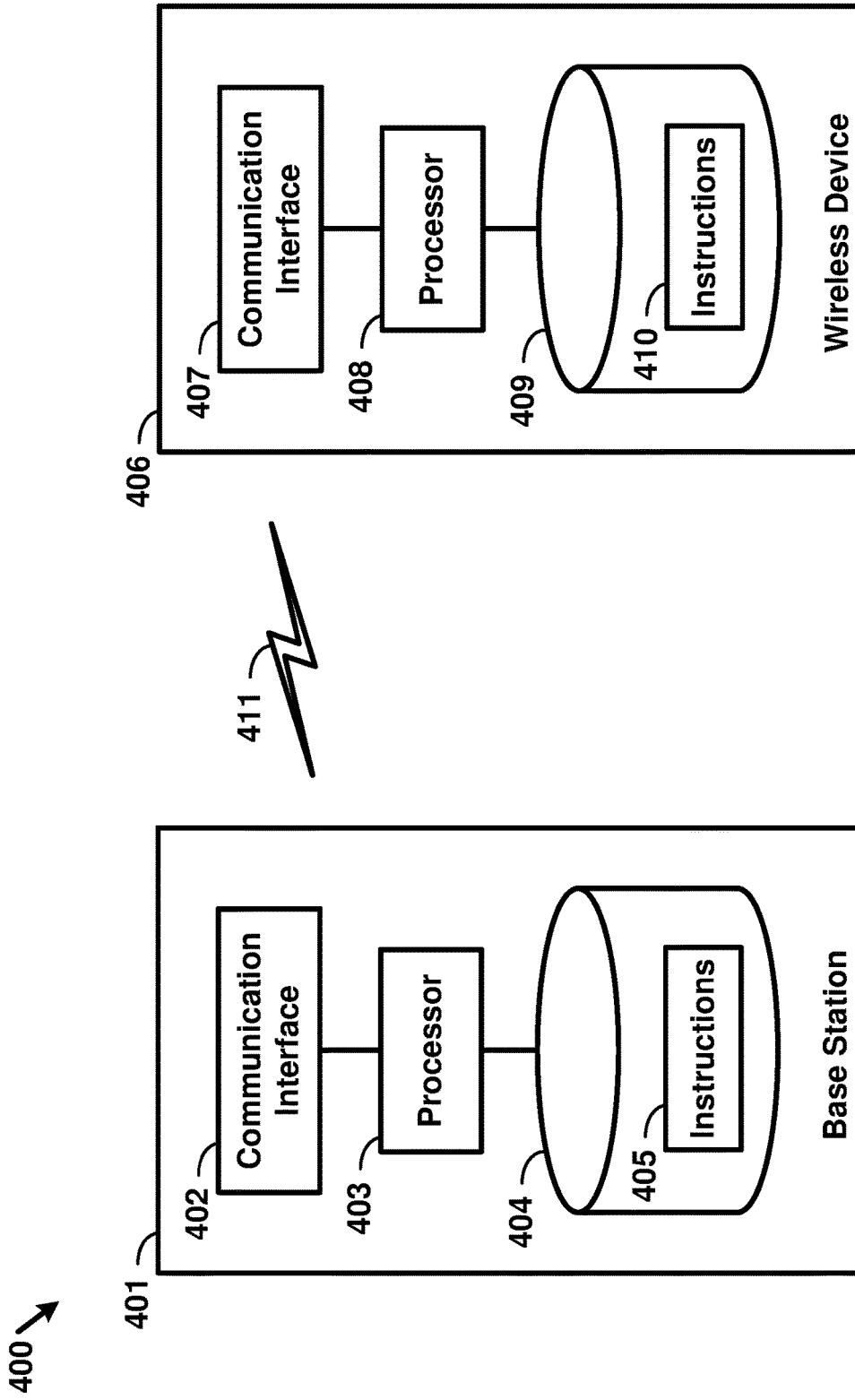

FIG. 4

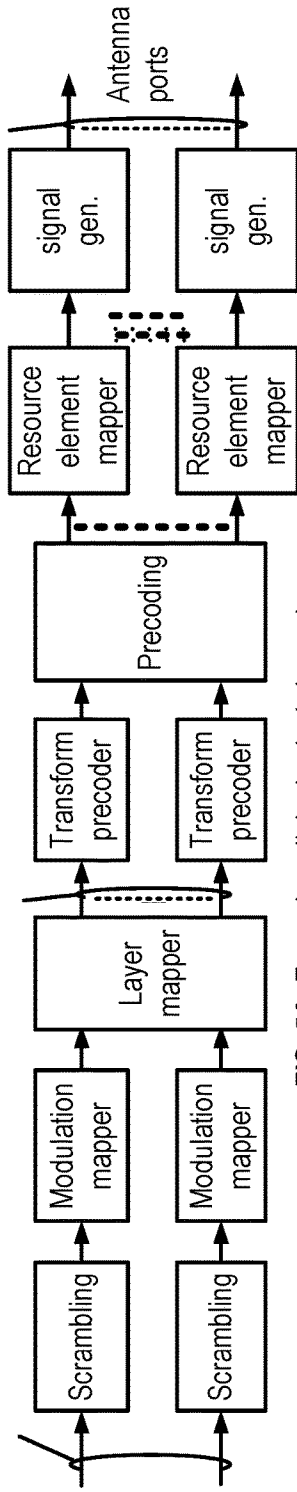

FIG. 5A Example uplink physical channel

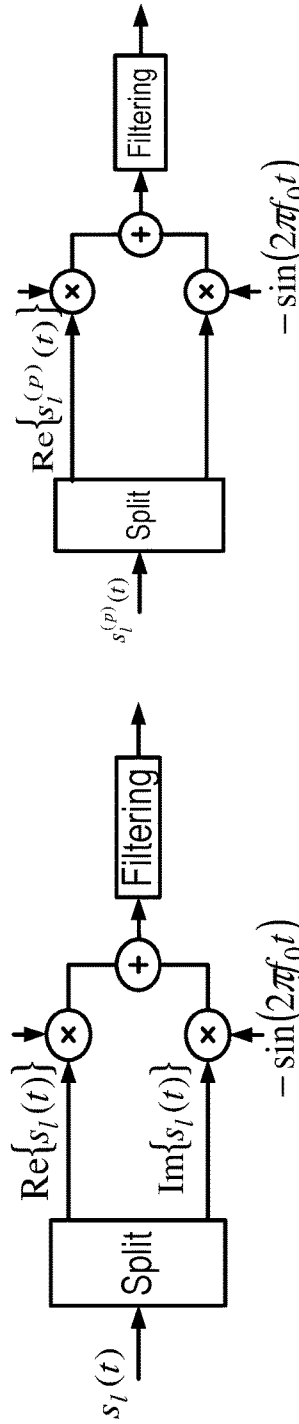

FIG. 5B Example uplink modulation

FIG. 5D Example downlink modulation

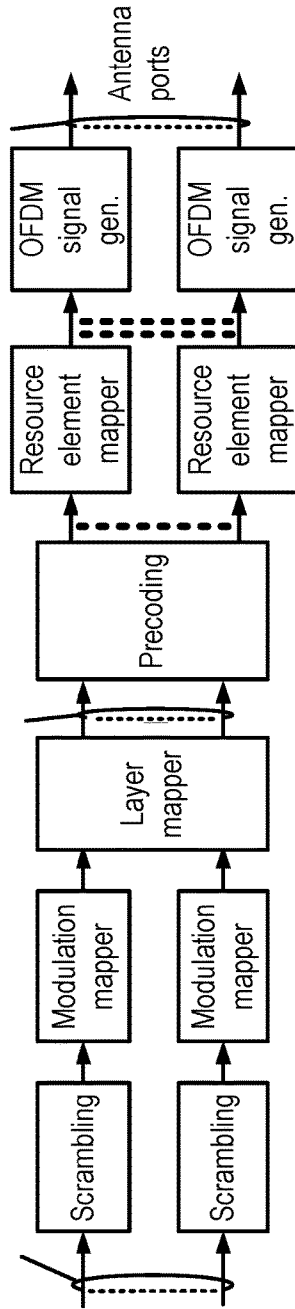
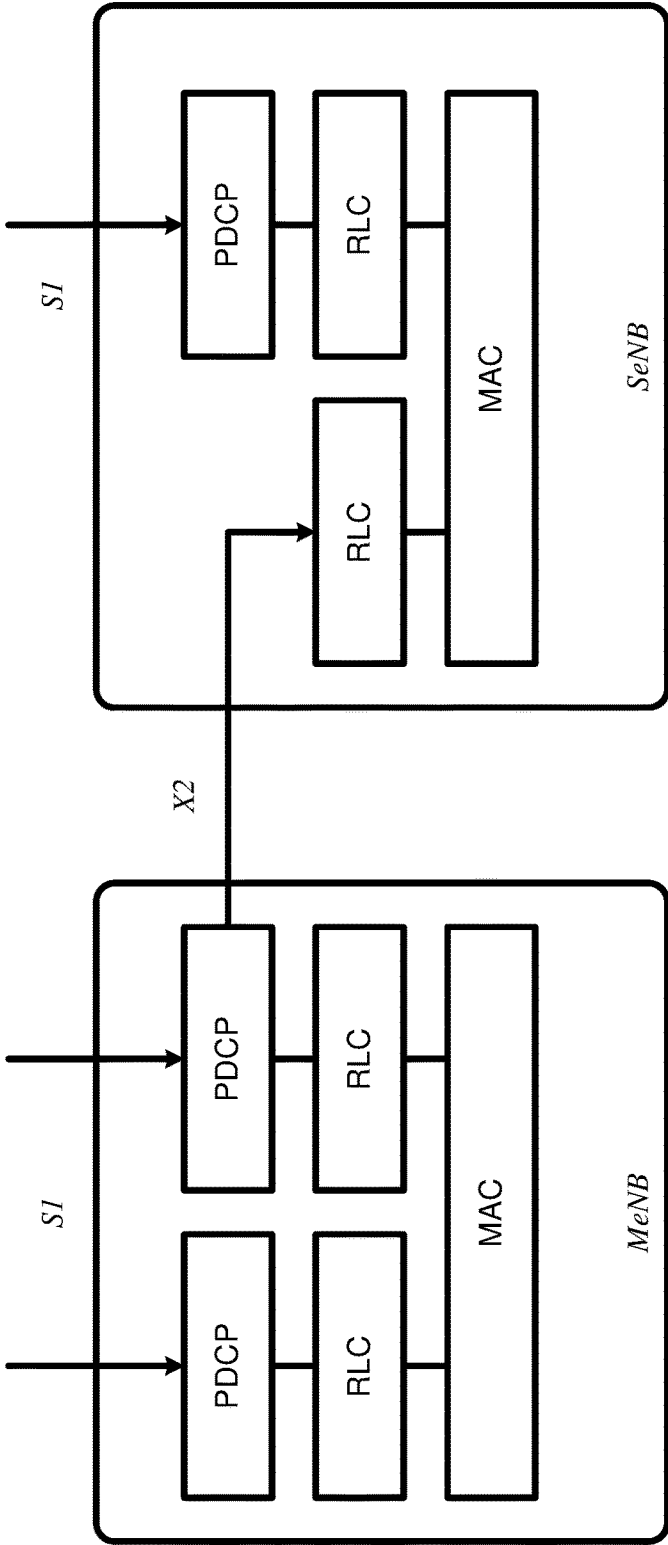
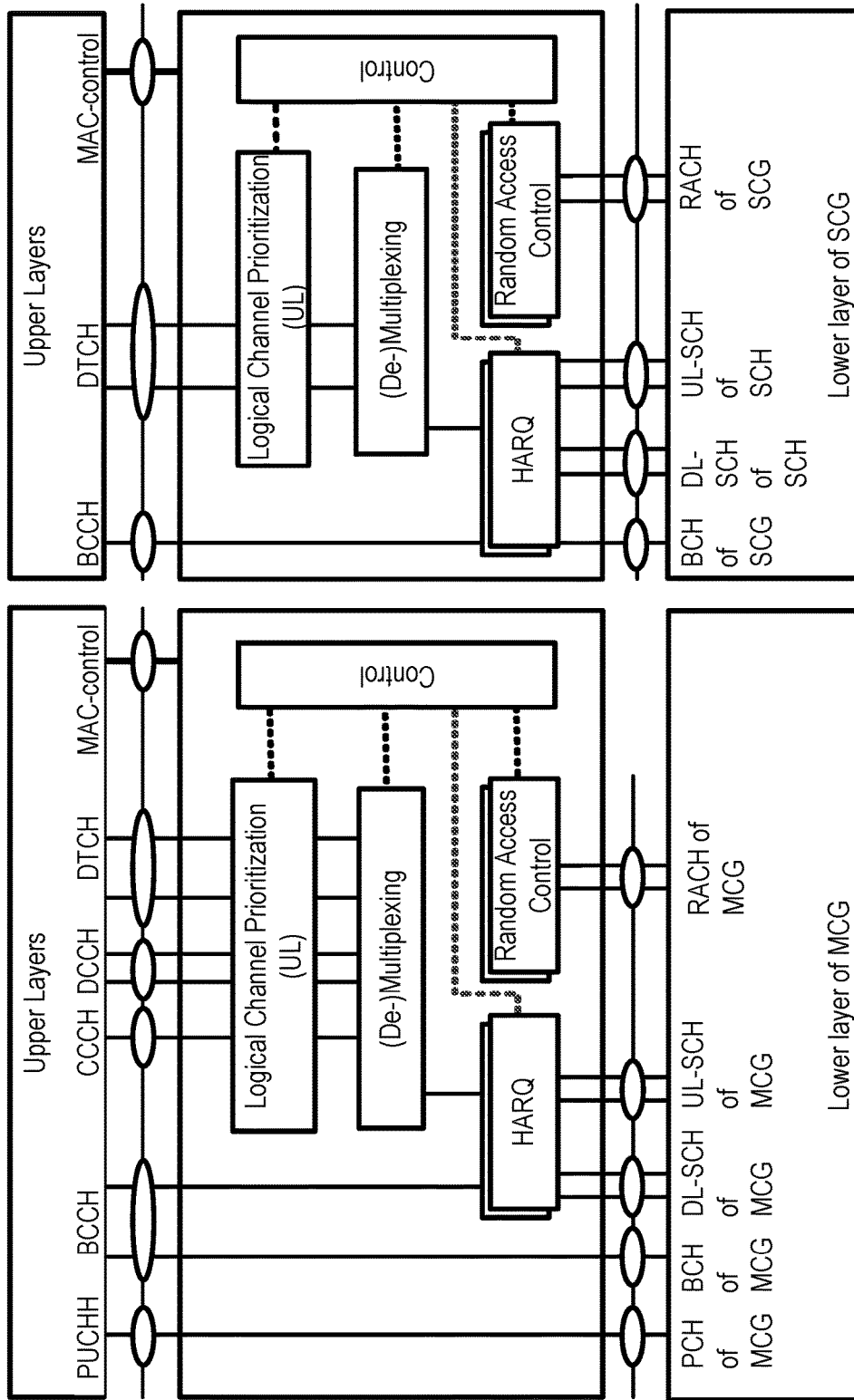

FIG. 5C Example downlink physical channel



Dual-Connectivity at eNB

FIG. 6



Dual-Connectivity- two MAC entities at UE side

FIG. 7

Example 1:

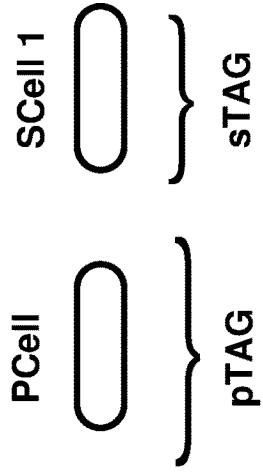

Example 2:

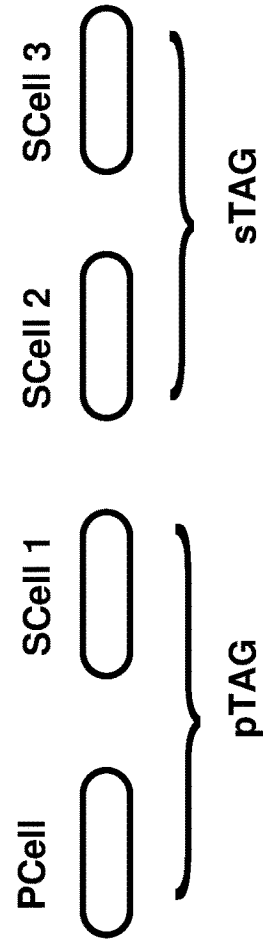

Example 3:

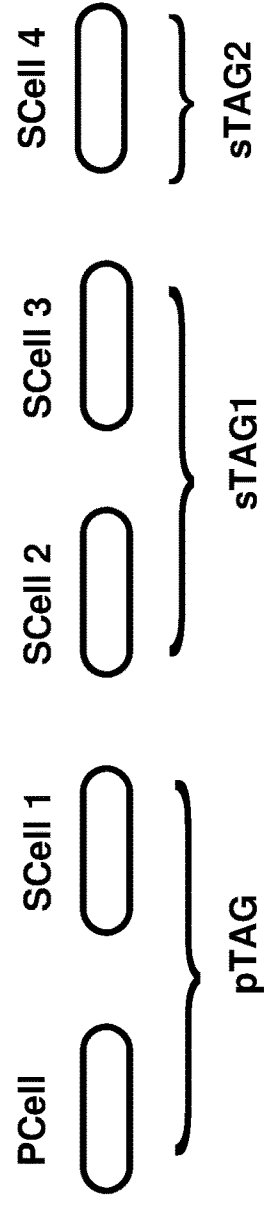

FIG. 8

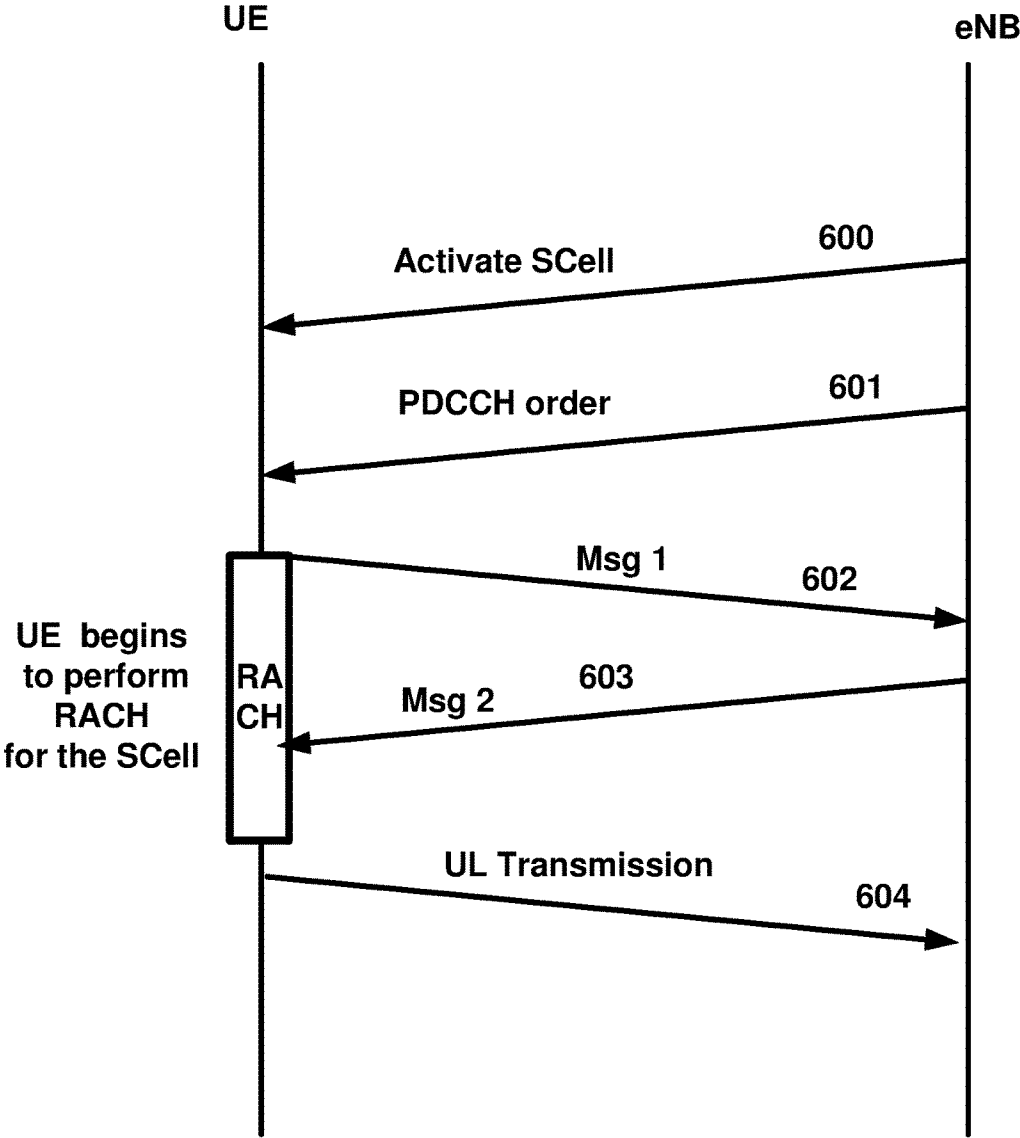

FIG. 9

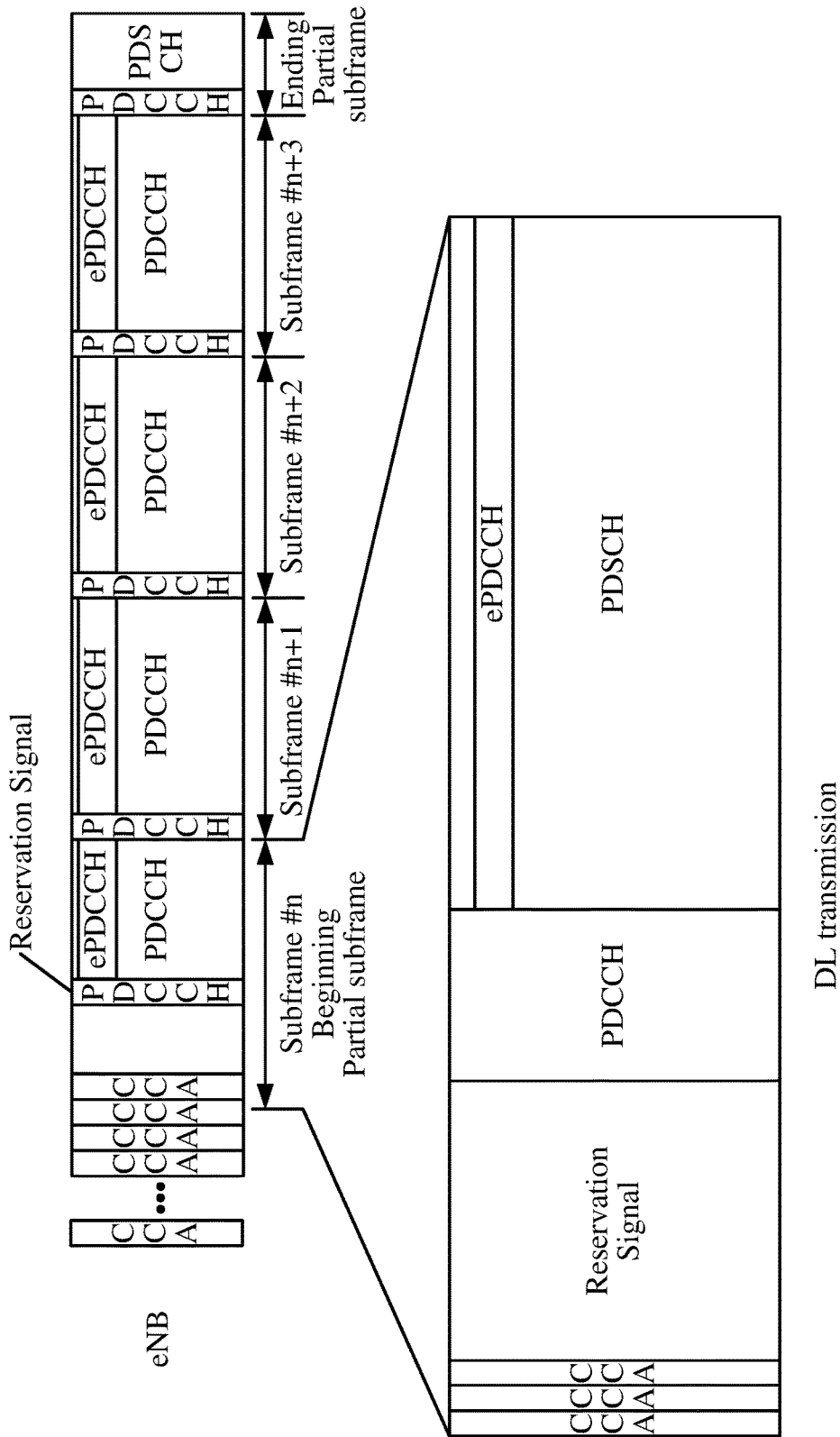

FIG. 10

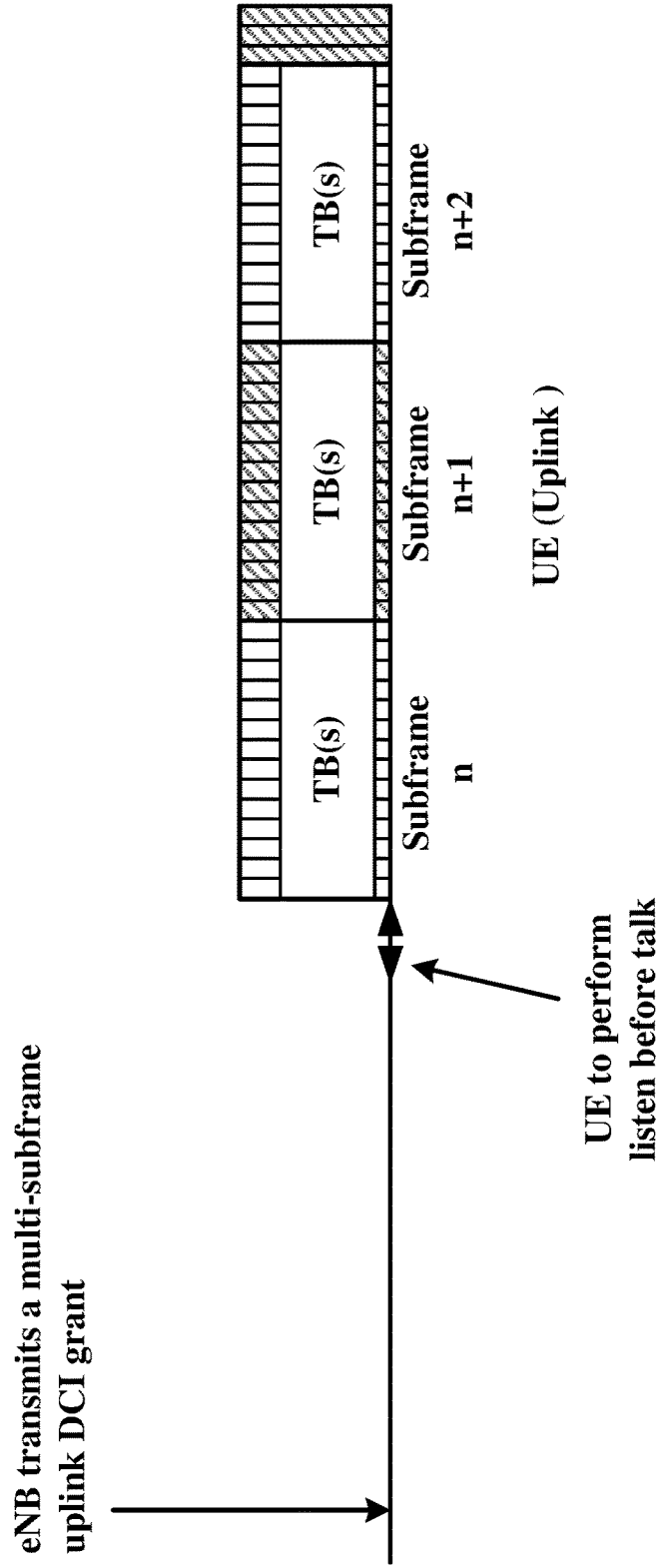

FIG. 11

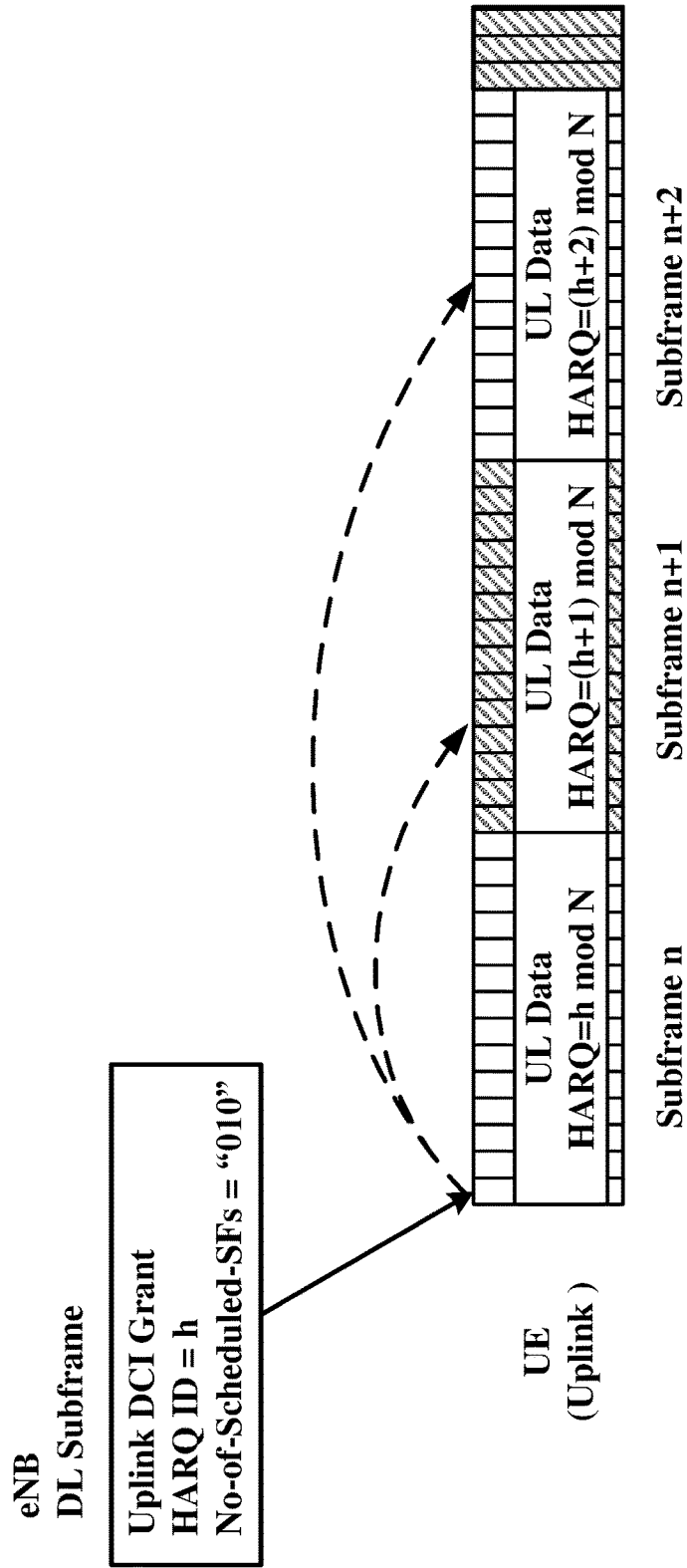

FIG. 12

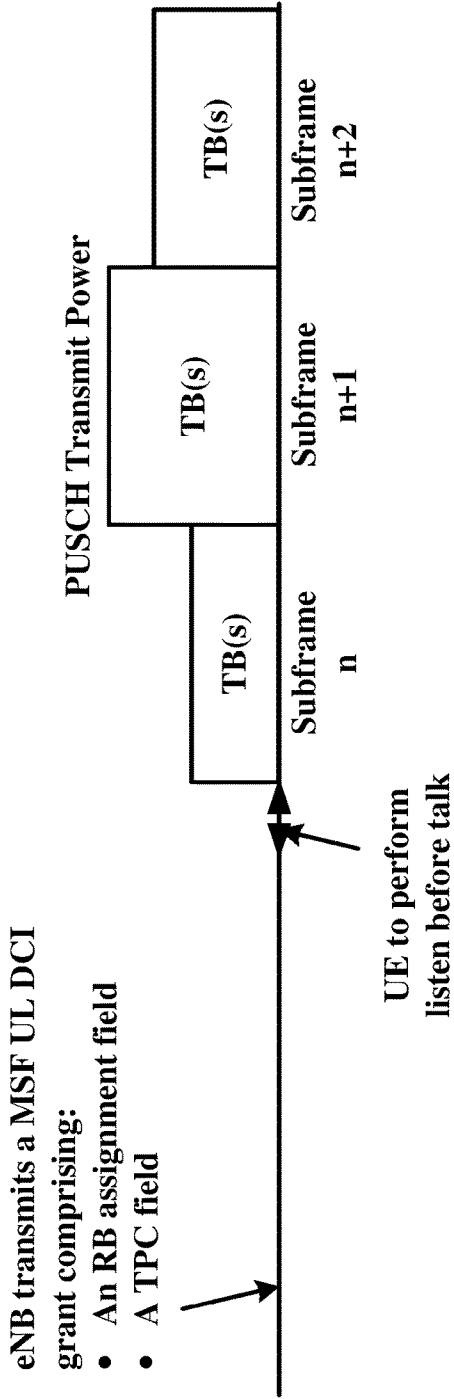

FIG. 13A

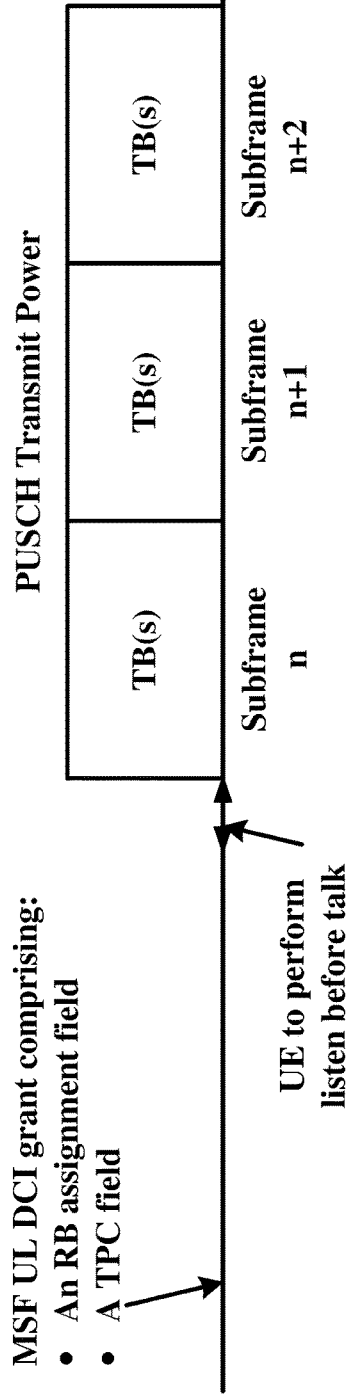

FIG. 13B

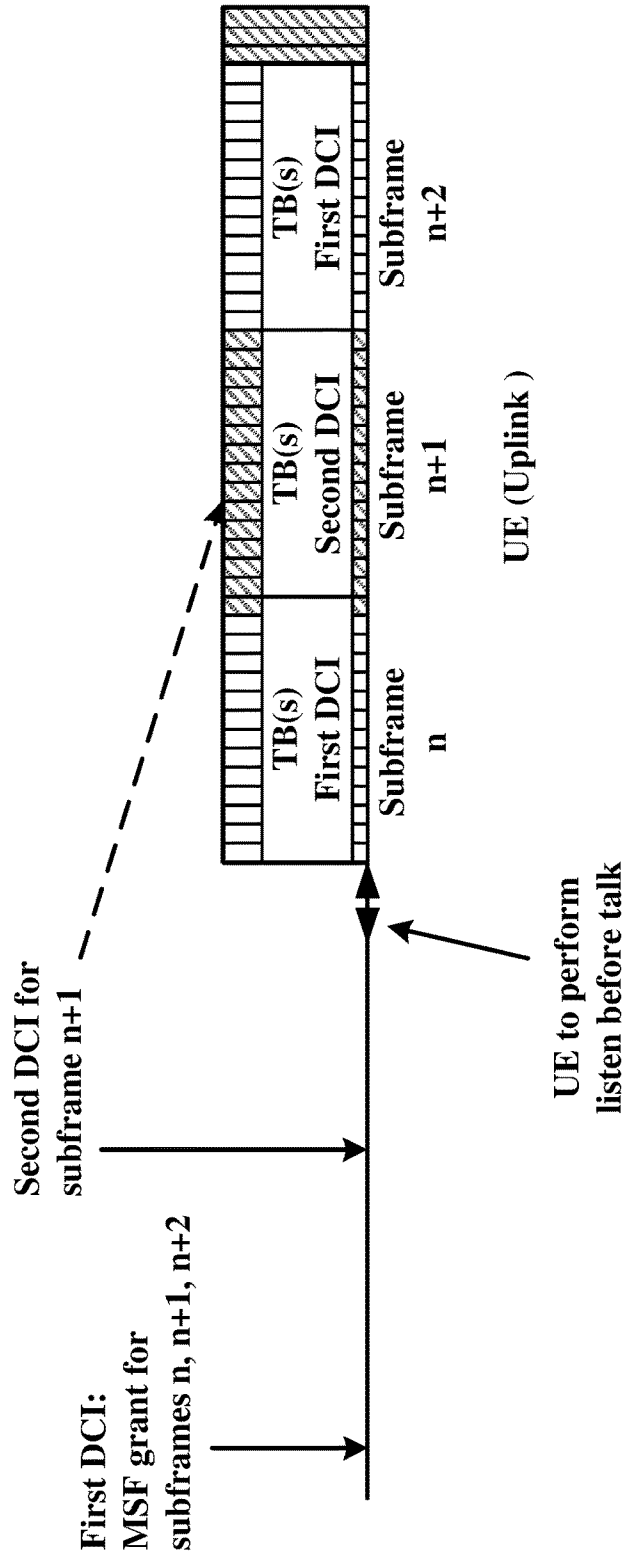

FIG. 14

No of scheduled subframes field: 3		
Resource Block field		
MCS field		
TPC field		
LBT field(s)		
HARQ ID		
Redundancy Version 1	Redundancy Version 2	Redundancy Version 3
New Data Indicator 1	New Data Indicator 2	New Data Indicator 3

**Example fields of an example MSFG DCI
when the number of scheduled subframes
is 3** ●●●

FIG. 15

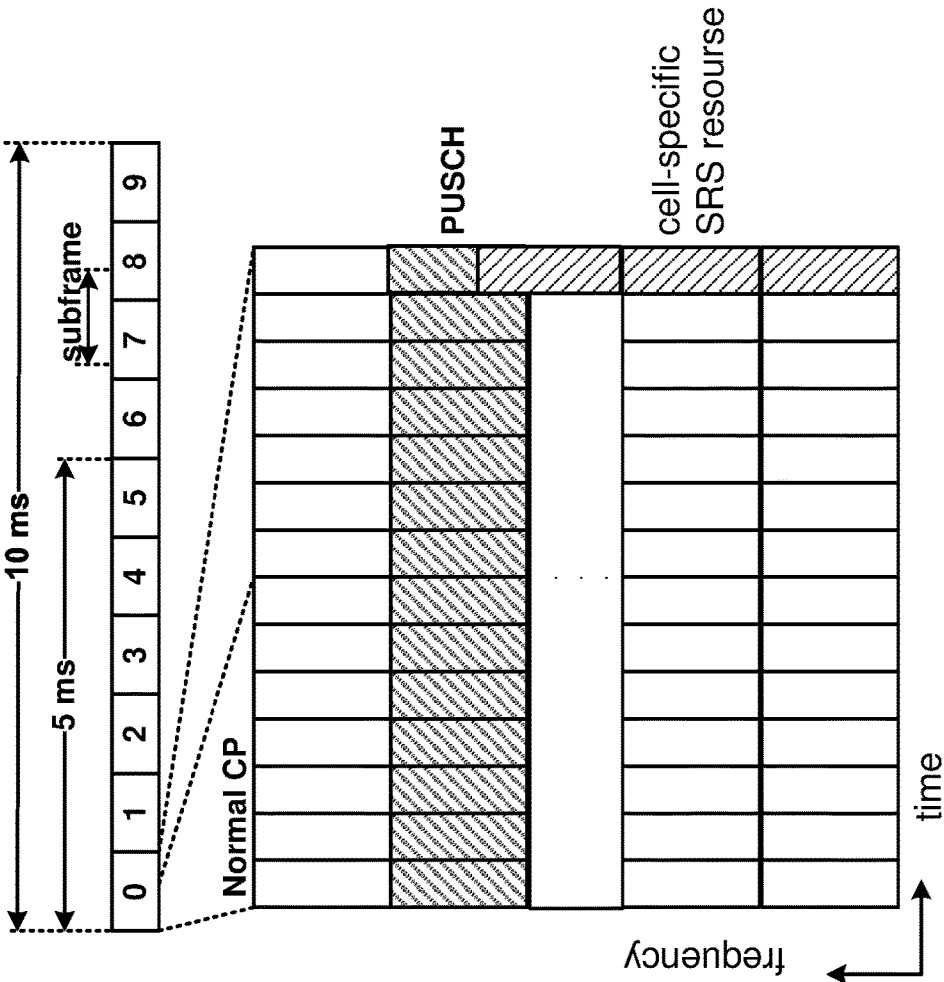

FIG. 16

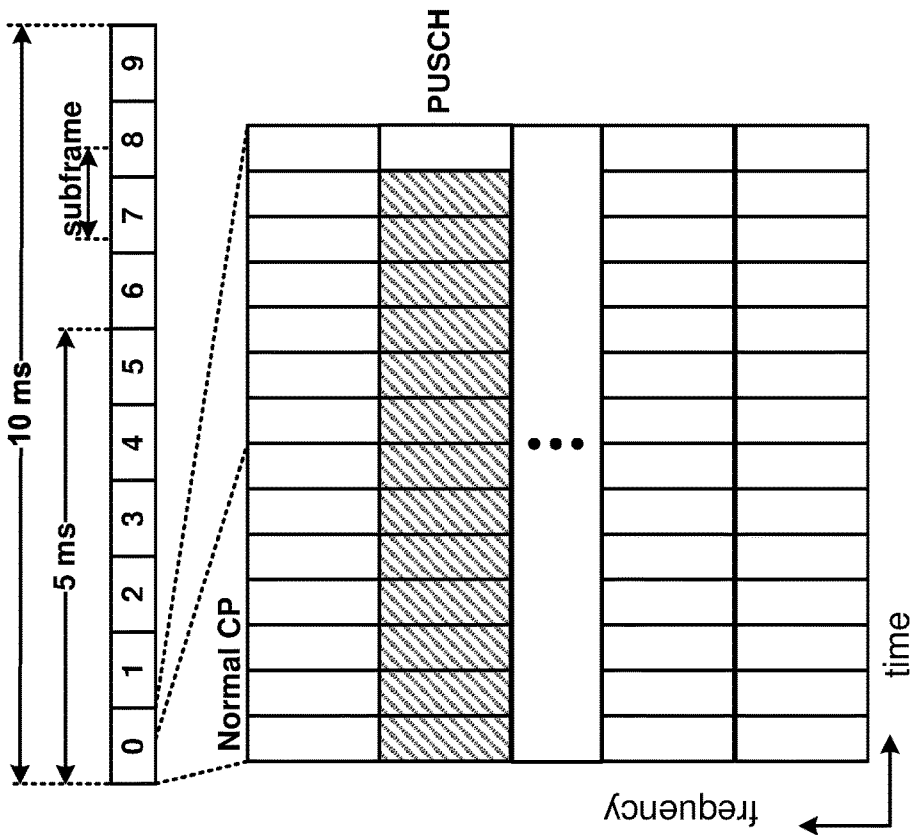

FIG. 17

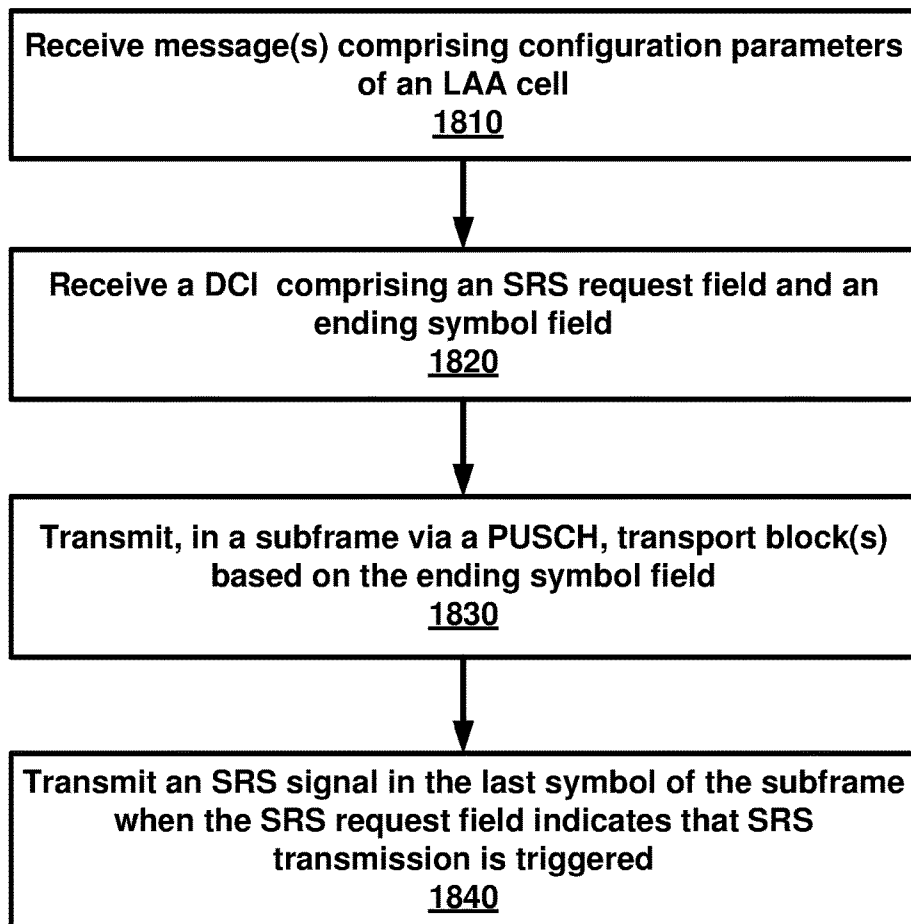

FIG. 18

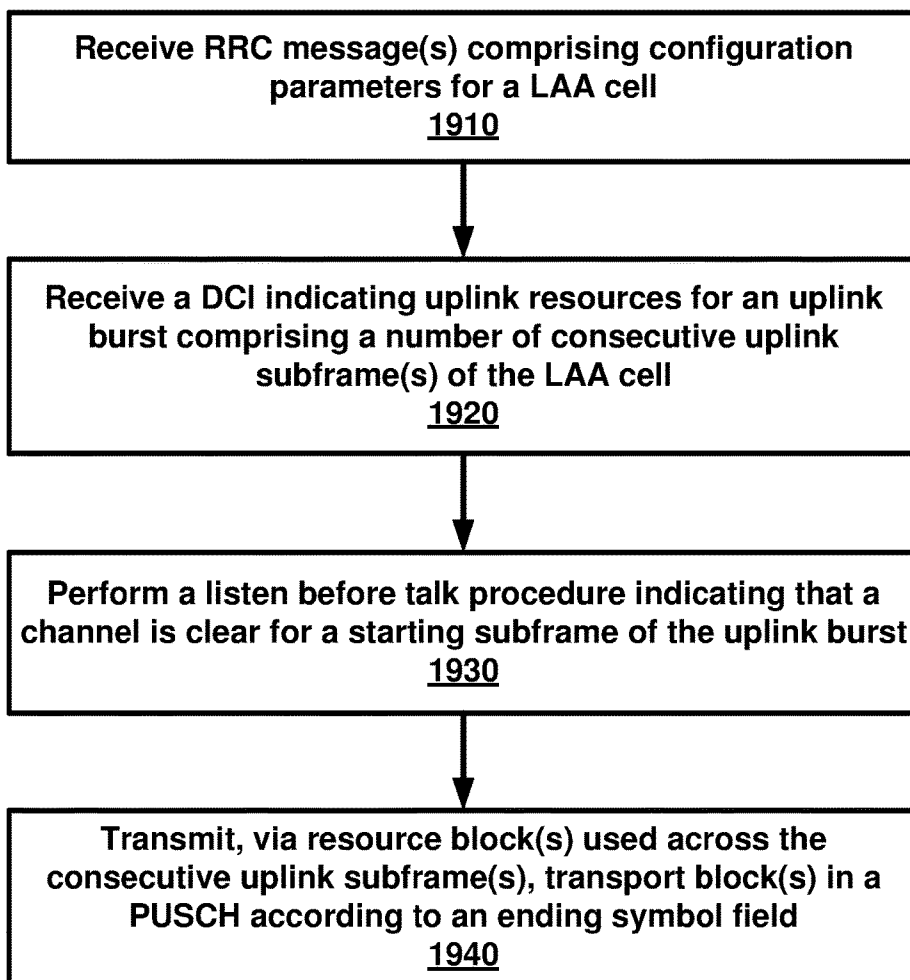

FIG. 19

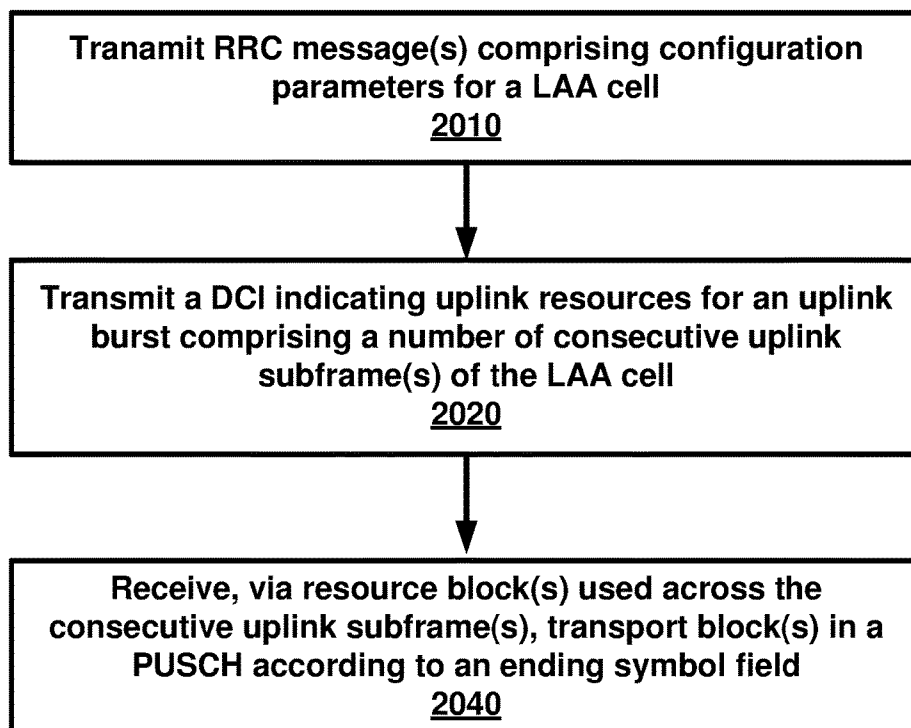

FIG. 20

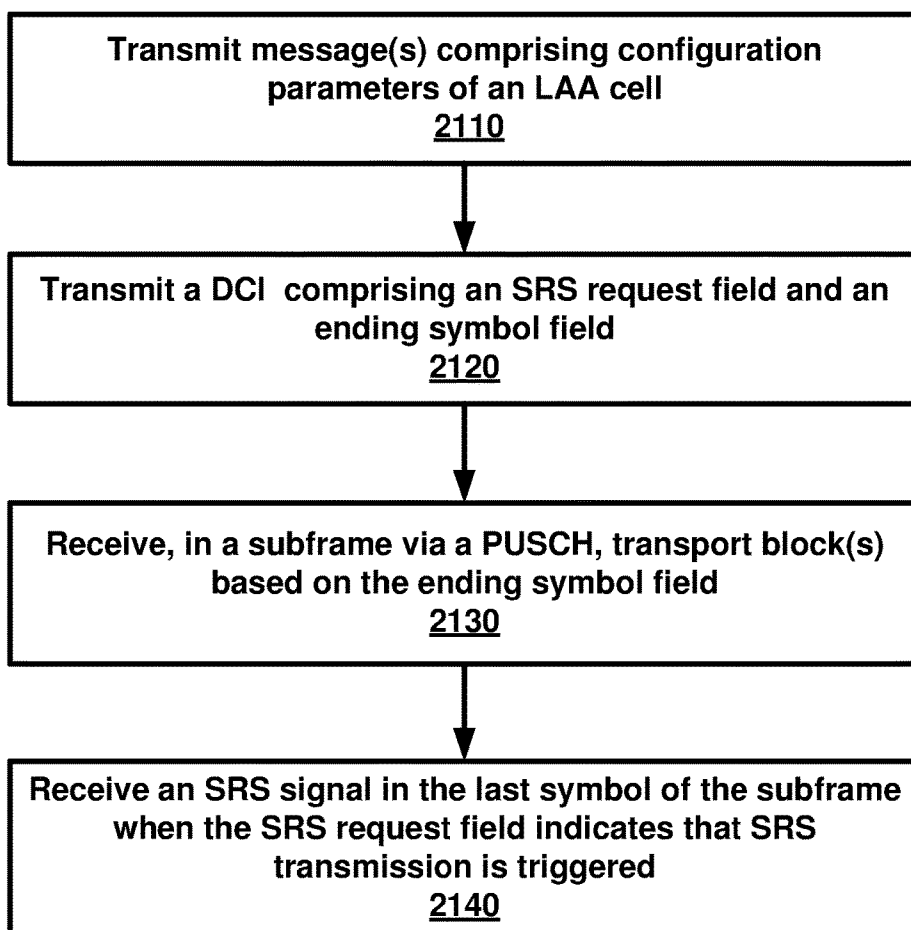

FIG. 21

DOWNLINK CONTROL INFORMATION IN A WIRELESS DEVICE AND WIRELESS NETWORK

CROSS-REFERENCE TO RELATED APPLICATIONS

[0001] This application claims the benefit of U.S. Provisional Application No. 62/289,949, filed Feb. 2, 2016, and U.S. Provisional Application 62/290,738, filed Feb. 3, 2016, which are hereby incorporated by reference in its entirety.

BRIEF DESCRIPTION OF THE SEVERAL VIEWS OF THE DRAWINGS

[0002] Examples of several of the various embodiments of the present disclosure are described herein with reference to the drawings.

[0003] FIG. 1 is a diagram depicting example sets of OFDM subcarriers as per an aspect of an embodiment of the present disclosure.

[0004] FIG. 2 is a diagram depicting an example transmission time and reception time for two carriers in a carrier group as per an aspect of an embodiment of the present disclosure.

[0005] FIG. 3 is an example diagram depicting OFDM radio resources as per an aspect of an embodiment of the present disclosure.

[0006] FIG. 4 is an example block diagram of a base station and a wireless device as per an aspect of an embodiment of the present disclosure.

[0007] FIG. 5A, FIG. 5B, FIG. 5C and FIG. 5D are example diagrams for uplink and downlink signal transmission as per an aspect of an embodiment of the present disclosure.

[0008] FIG. 6 is an example diagram for a protocol structure with CA and DC as per an aspect of an embodiment of the present disclosure.

[0009] FIG. 7 is an example diagram for a protocol structure with CA and DC as per an aspect of an embodiment of the present disclosure.

[0010] FIG. 8 shows example TAG configurations as per an aspect of an embodiment of the present disclosure.

[0011] FIG. 9 is an example message flow in a random access process in a secondary TAG as per an aspect of an embodiment of the present disclosure.

[0012] FIG. 10 is an example diagram depicting a downlink burst as per an aspect of an embodiment of the present disclosure.

[0013] FIG. 11 is an example diagram depicting a plurality of cells as per an aspect of an embodiment of the present disclosure.

[0014] FIG. 12 is an example diagram depicting a plurality of cells as per an aspect of an embodiment of the present disclosure.

[0015] FIG. 13A and FIG. 13B are an example diagrams depicting a plurality of cells as per an aspect of an embodiment of the present disclosure.

[0016] FIG. 14 is an example diagram depicting a plurality of cells as per an aspect of an embodiment of the present disclosure.

[0017] FIG. 15 is an example diagram depicting example DCI fields as per an aspect of an embodiment of the present disclosure.

[0018] FIG. 16 is an example diagram illustrating uplink signals as per an aspect of an embodiment of the present disclosure.

[0019] FIG. 17 is an example diagram illustrating uplink signals as per an aspect of an embodiment of the present disclosure.

[0020] FIG. 18 is an example flow diagram illustrating an aspect of an embodiment of the present disclosure.

[0021] FIG. 19 is an example flow diagram illustrating an aspect of an embodiment of the present disclosure.

[0022] FIG. 20 is an example flow diagram illustrating an aspect of an embodiment of the present disclosure.

[0023] FIG. 21 is an example flow diagram illustrating an aspect of an embodiment of the present disclosure.

DETAILED DESCRIPTION OF EMBODIMENTS

[0024] Example embodiments of the present disclosure enable operation of carrier aggregation. Embodiments of the technology disclosed herein may be employed in the technical field of multicarrier communication systems.

[0025] The following Acronyms are used throughout the present disclosure:

- [0026] ASIC application-specific integrated circuit
- [0027] BPSK binary phase shift keying
- [0028] CA carrier aggregation
- [0029] CSI channel state information
- [0030] CDMA code division multiple access
- [0031] CSS common search space
- [0032] CPLD complex programmable logic devices
- [0033] CC component carrier
- [0034] DL downlink
- [0035] DCI downlink control information
- [0036] DC dual connectivity
- [0037] EPC evolved packet core
- [0038] E-UTRAN evolved-universal terrestrial radio access network
- [0039] FPGA field programmable gate arrays
- [0040] FDD frequency division multiplexing
- [0041] HDL hardware description languages
- [0042] HARQ hybrid automatic repeat request
- [0043] IE information element
- [0044] LAA licensed assisted access
- [0045] LTE long term evolution
- [0046] MCG master cell group
- [0047] MeNB master evolved node B
- [0048] MIB master information block
- [0049] MAC media access control
- [0050] MAC media access control
- [0051] MME mobility management entity
- [0052] NAS non-access stratum
- [0053] OFDM orthogonal frequency division multiplexing
- [0054] PDCP packet data convergence protocol
- [0055] PDU packet data unit
- [0056] PHY physical
- [0057] PDCCH physical downlink control channel
- [0058] PHICH physical HARQ indicator channel
- [0059] PUCCH physical uplink control channel
- [0060] PUSCH physical uplink shared channel
- [0061] PCell primary cell
- [0062] PCell primary cell
- [0063] PCC primary component carrier
- [0064] PSCell primary secondary cell
- [0065] pTAG primary timing advance group

[0066] QAM quadrature amplitude modulation
 [0067] QPSK quadrature phase shift keying
 [0068] RBG Resource Block Groups
 [0069] RLC radio link control
 [0070] RRC radio resource control
 [0071] RA random access
 [0072] RB resource blocks
 [0073] SCC secondary component carrier
 [0074] SCell secondary cell
 [0075] Scell secondary cells
 [0076] SCG secondary cell group
 [0077] SeNB secondary evolved node B
 [0078] sTAGs secondary timing advance group
 [0079] SDU service data unit
 [0080] S-GW serving gateway
 [0081] SRB signaling radio bearer
 [0082] SC-OFDM single carrier-OFDM
 [0083] SFN system frame number
 [0084] SIB system information block
 [0085] TAI tracking area identifier
 [0086] TAT time alignment timer
 [0087] TDD time division duplexing
 [0088] TDMA time division multiple access
 [0089] TA timing advance
 [0090] TAG timing advance group
 [0091] TB transport block
 [0092] UL uplink
 [0093] UE user equipment
 [0094] VHDL VHSIC hardware description language
 [0095] Example embodiments of the disclosure may be implemented using various physical layer modulation and transmission mechanisms. Example transmission mechanisms may include, but are not limited to: CDMA, OFDM, TDMA, Wavelet technologies, and/or the like. Hybrid transmission mechanisms such as TDMA/CDMA, and OFDM/CDMA may also be employed. Various modulation schemes may be applied for signal transmission in the physical layer. Examples of modulation schemes include, but are not limited to: phase, amplitude, code, a combination of these, and/or the like. An example radio transmission method may implement QAM using BPSK, QPSK, 16-QAM, 64-QAM, 256-QAM, and/or the like. Physical radio transmission may be enhanced by dynamically or semi-dynamically changing the modulation and coding scheme depending on transmission requirements and radio conditions.
 [0096] FIG. 1 is a diagram depicting example sets of OFDM subcarriers as per an aspect of an embodiment of the present disclosure. As illustrated in this example, arrow(s) in the diagram may depict a subcarrier in a multicarrier OFDM system. The OFDM system may use technology such as OFDM technology, DFTS-OFDM, SC-OFDM technology, or the like. For example, arrow 101 shows a subcarrier transmitting information symbols. FIG. 1 is for illustration purposes, and a typical multicarrier OFDM system may include more subcarriers in a carrier. For example, the number of subcarriers in a carrier may be in the range of 10 to 10,000 subcarriers. FIG. 1 shows two guard bands 106 and 107 in a transmission band. As illustrated in FIG. 1, guard band 106 is between subcarriers 103 and subcarriers 104. The example set of subcarriers A 102 includes subcarriers 103 and subcarriers 104. FIG. 1 also illustrates an example set of subcarriers B 105. As illustrated, there is no guard band between any two subcarriers in the example set of subcarriers B 105. Carriers in a multicarrier OFDM

communication system may be contiguous carriers, non-contiguous carriers, or a combination of both contiguous and non-contiguous carriers.

[0097] FIG. 2 is a diagram depicting an example transmission time and reception time for two carriers as per an aspect of an embodiment of the present disclosure. A multicarrier OFDM communication system may include one or more carriers, for example, ranging from 1 to 10 carriers. Carrier A 204 and carrier B 205 may have the same or different timing structures. Although FIG. 2 shows two synchronized carriers, carrier A 204 and carrier B 205 may or may not be synchronized with each other. Different radio frame structures may be supported for FDD and TDD duplex mechanisms. FIG. 2 shows an example FDD frame timing. Downlink and uplink transmissions may be organized into radio frames 201. In this example, the radio frame duration is 10 msec. Other frame durations, for example, in the range of 1 to 100 msec may also be supported. In this example, each 10 ms radio frame 201 may be divided into ten equally sized subframes 202. Other subframe durations such as 0.5 msec, 1 msec, 2 msec, and 5 msec may also be supported. Subframe(s) may consist of two or more slots (for example, slots 206 and 207). For the example of FDD, 10 subframes may be available for downlink transmission and 10 subframes may be available for uplink transmissions in each 10 ms interval. Uplink and downlink transmissions may be separated in the frequency domain. Slot(s) may include a plurality of OFDM symbols 203. The number of OFDM symbols 203 in a slot 206 may depend on the cyclic prefix length and subcarrier spacing.

[0098] FIG. 3 is a diagram depicting OFDM radio resources as per an aspect of an embodiment of the present disclosure. The resource grid structure in time 304 and frequency 305 is illustrated in FIG. 3. The quantity of downlink subcarriers or RBs (in this example 6 to 100 RBs) may depend, at least in part, on the downlink transmission bandwidth 306 configured in the cell. The smallest radio resource unit may be called a resource element (e.g. 301). Resource elements may be grouped into resource blocks (e.g. 302). Resource blocks may be grouped into larger radio resources called Resource Block Groups (RBG) (e.g. 303). The transmitted signal in slot 206 may be described by one or several resource grids of a plurality of subcarriers and a plurality of OFDM symbols. Resource blocks may be used to describe the mapping of certain physical channels to resource elements. Other pre-defined groupings of physical resource elements may be implemented in the system depending on the radio technology. For example, 24 subcarriers may be grouped as a radio block for a duration of 5 msec. In an illustrative example, a resource block may correspond to one slot in the time domain and 180 kHz in the frequency domain (for 15 KHz subcarrier bandwidth and 12 subcarriers).

[0099] FIG. 5A, FIG. 5B, FIG. 5C and FIG. 5D are example diagrams for uplink and downlink signal transmission as per an aspect of an embodiment of the present disclosure. FIG. 5A shows an example uplink physical channel. The baseband signal representing the physical uplink shared channel may perform the following processes. These functions are illustrated as examples and it is anticipated that other mechanisms may be implemented in various embodiments. The functions may comprise scrambling, modulation of scrambled bits to generate complex-valued symbols, mapping of the complex-valued modulation sym-

bols onto one or several transmission layers, transform precoding to generate complex-valued symbols, precoding of the complex-valued symbols, mapping of precoded complex-valued symbols to resource elements, generation of complex-valued time-domain DFTS-OFDM/SC-TDMA signal for each antenna port, and/or the like.

[0100] Example modulation and up-conversion to the carrier frequency of the complex-valued DFTS-OFDM/SC-TDMA baseband signal for each antenna port and/or the complex-valued PRACH baseband signal is shown in FIG. 5B. Filtering may be employed prior to transmission.

[0101] An example structure for Downlink Transmissions is shown in FIG. 5C. The baseband signal representing a downlink physical channel may perform the following processes. These functions are illustrated as examples and it is anticipated that other mechanisms may be implemented in various embodiments. The functions include scrambling of coded bits in each of the codewords to be transmitted on a physical channel; modulation of scrambled bits to generate complex-valued modulation symbols; mapping of the complex-valued modulation symbols onto one or several transmission layers; precoding of the complex-valued modulation symbols on each layer for transmission on the antenna ports; mapping of complex-valued modulation symbols for each antenna port to resource elements; generation of complex-valued time-domain OFDM signal for each antenna port, and/or the like.

[0102] Example modulation and up-conversion to the carrier frequency of the complex-valued OFDM baseband signal for each antenna port is shown in FIG. 5D. Filtering may be employed prior to transmission.

[0103] FIG. 4 is an example block diagram of a base station 401 and a wireless device 406, as per an aspect of an embodiment of the present disclosure. A communication network 400 may include at least one base station 401 and at least one wireless device 406. The base station 401 may include at least one communication interface 402, at least one processor 403, and at least one set of program code instructions 405 stored in non-transitory memory 404 and executable by the at least one processor 403. The wireless device 406 may include at least one communication interface 407, at least one processor 408, and at least one set of program code instructions 410 stored in non-transitory memory 409 and executable by the at least one processor 408. Communication interface 402 in base station 401 may be configured to engage in communication with communication interface 407 in wireless device 406 via a communication path that includes at least one wireless link 411. Wireless link 411 may be a bi-directional link. Communication interface 407 in wireless device 406 may also be configured to engage in a communication with communication interface 402 in base station 401. Base station 401 and wireless device 406 may be configured to send and receive data over wireless link 411 using multiple frequency carriers. According to aspects of an embodiment, transceiver(s) may be employed. A transceiver is a device that includes both a transmitter and receiver. Transceivers may be employed in devices such as wireless devices, base stations, relay nodes, and/or the like. Example embodiments for radio technology implemented in communication interface 402, 407 and wireless link 411 are illustrated in FIG. 1, FIG. 2, FIG. 3, FIG. 5, and associated text.

[0104] An interface may be a hardware interface, a firmware interface, a software interface, and/or a combination

thereof. The hardware interface may include connectors, wires, electronic devices such as drivers, amplifiers, and/or the like. A software interface may include code stored in a memory device to implement protocol(s), protocol layers, communication drivers, device drivers, combinations thereof, and/or the like. A firmware interface may include a combination of embedded hardware and code stored in and/or in communication with a memory device to implement connections, electronic device operations, protocol(s), protocol layers, communication drivers, device drivers, hardware operations, combinations thereof, and/or the like.

[0105] The term configured may relate to the capacity of a device whether the device is in an operational or non-operational state. Configured may also refer to specific settings in a device that effect the operational characteristics of the device whether the device is in an operational or non-operational state. In other words, the hardware, software, firmware, registers, memory values, and/or the like may be “configured” within a device, whether the device is in an operational or nonoperational state, to provide the device with specific characteristics. Terms such as “a control message to cause in a device” may mean that a control message has parameters that may be used to configure specific characteristics in the device, whether the device is in an operational or non-operational state.

[0106] According to various aspects of an embodiment, an LTE network may include a multitude of base stations, providing a user plane PDCP/RLC/MAC/PHY and control plane (RRC) protocol terminations towards the wireless device. The base station(s) may be interconnected with other base station(s) (for example, interconnected employing an X2 interface). Base stations may also be connected employing, for example, an S1 interface to an EPC. For example, base stations may be interconnected to the MME employing the S1-MME interface and to the S-G) employing the S1-U interface. The S1 interface may support a many-to-many relation between MMEs/Serving Gateways and base stations. A base station may include many sectors for example: 1, 2, 3, 4, or 6 sectors. A base station may include many cells, for example, ranging from 1 to 50 cells or more. A cell may be categorized, for example, as a primary cell or secondary cell. At RRC connection establishment/re-establishment/handover, one serving cell may provide the NAS (non-access stratum) mobility information (e.g. TAI), and at RRC connection re-establishment/handover, one serving cell may provide the security input. This cell may be referred to as the Primary Cell (PCell). In the downlink, the carrier corresponding to the PCell may be the Downlink Primary Component Carrier (DL PCC), while in the uplink, the carrier corresponding to the PCell may be the Uplink Primary Component Carrier (UL PCC). Depending on wireless device capabilities, Secondary Cells (SCells) may be configured to form together with the PCell a set of serving cells. In the downlink, the carrier corresponding to an SCell may be a Downlink Secondary Component Carrier (DL SCC), while in the uplink, it may be an Uplink Secondary Component Carrier (UL SCC). An SCell may or may not have an uplink carrier.

[0107] A cell, comprising a downlink carrier and optionally an uplink carrier, may be assigned a physical cell ID and a cell index. A carrier (downlink or uplink) may belong to only one cell. The cell ID or Cell index may also identify the downlink carrier or uplink carrier of the cell (depending on the context it is used). In the specification, cell ID may be

equally referred to a carrier ID, and cell index may be referred to carrier index. In implementation, the physical cell ID or cell index may be assigned to a cell. A cell ID may be determined using a synchronization signal transmitted on a downlink carrier. A cell index may be determined using RRC messages. For example, when the specification refers to a first physical cell ID for a first downlink carrier, the specification may mean the first physical cell ID is for a cell comprising the first downlink carrier. The same concept may apply, for example, to carrier activation. When the specification indicates that a first carrier is activated, the specification may also mean that the cell comprising the first carrier is activated.

[0108] Embodiments may be configured to operate as needed. The disclosed mechanism may be performed when certain criteria are met, for example, in a wireless device, a base station, a radio environment, a network, a combination of the above, and/or the like. Example criteria may be based, at least in part, on for example, traffic load, initial system set up, packet sizes, traffic characteristics, a combination of the above, and/or the like. When the one or more criteria are met, various example embodiments may be applied. Therefore, it may be possible to implement example embodiments that selectively implement disclosed protocols.

[0109] A base station may communicate with a mix of wireless devices. Wireless devices may support multiple technologies, and/or multiple releases of the same technology. Wireless devices may have some specific capability (ies) depending on its wireless device category and/or capability(ies). A base station may comprise multiple sectors. When this disclosure refers to a base station communicating with a plurality of wireless devices, this disclosure may refer to a subset of the total wireless devices in a coverage area. This disclosure may refer to, for example, a plurality of wireless devices of a given LTE release with a given capability and in a given sector of the base station. The plurality of wireless devices in this disclosure may refer to a selected plurality of wireless devices, and/or a subset of total wireless devices in a coverage area which perform according to disclosed methods, and/or the like. There may be a plurality of wireless devices in a coverage area that may not comply with the disclosed methods, for example, because those wireless devices perform based on older releases of LTE technology.

[0110] FIG. 6 and FIG. 7 are example diagrams for protocol structure with CA and DC as per an aspect of an embodiment of the present disclosure. E-UTRAN may support Dual Connectivity (DC) operation whereby a multiple RX/TX UE in RRC_CONNECTED may be configured to utilize radio resources provided by two schedulers located in two eNBs connected via a non-ideal backhaul over the X2 interface. eNBs involved in DC for a certain UE may assume two different roles: an eNB may either act as an MeNB or as an SeNB. In DC a UE may be connected to one MeNB and one SeNB. Mechanisms implemented in DC may be extended to cover more than two eNBs. FIG. 7 illustrates one example structure for the UE side MAC entities when a Master Cell Group (MCG) and a Secondary Cell Group (SCG) are configured, and it may not restrict implementation. Media Broadcast Multicast Service (MBMS) reception is not shown in this figure for simplicity.

[0111] In DC, the radio protocol architecture that a particular bearer uses may depend on how the bearer is setup. Three alternatives may exist, an MCG bearer, an SCG bearer

and a split bearer as shown in FIG. 6. RRC may be located in MeNB and SRBs may be configured as a MCG bearer type and may use the radio resources of the MeNB. DC may also be described as having at least one bearer configured to use radio resources provided by the SeNB. DC may or may not be configured/implemented in example embodiments of the disclosure.

[0112] In the case of DC, the UE may be configured with two MAC entities: one MAC entity for MeNB, and one MAC entity for SeNB. In DC, the configured set of serving cells for a UE may comprise two subsets: the Master Cell Group (MCG) containing the serving cells of the MeNB, and the Secondary Cell Group (SCG) containing the serving cells of the SeNB. For a SCG, one or more of the following may be applied. At least one cell in the SCG may have a configured UL CC and one of them, named PSCell (or PCell of SCG, or sometimes called PCell), may be configured with PUCCH resources. When the SCG is configured, there may be at least one SCG bearer or one Split bearer. Upon detection of a physical layer problem or a random access problem on a PSCell, or the maximum number of RLC retransmissions has been reached associated with the SCG, or upon detection of an access problem on a PSCell during a SCG addition or a SCG change: a RRC connection re-establishment procedure may not be triggered, UL transmissions towards cells of the SCG may be stopped, and a MeNB may be informed by the UE of a SCG failure type. For split bearer, the DL data transfer over the MeNB may be maintained. The RLC AM bearer may be configured for the split bearer. Like a PCell, a PSCell may not be de-activated. A PSCell may be changed with a SCG change (for example, with a security key change and a RACH procedure), and/or neither a direct bearer type change between a Split bearer and a SCG bearer nor simultaneous configuration of a SCG and a Split bearer may be supported.

[0113] With respect to the interaction between a MeNB and a SeNB, one or more of the following principles may be applied. The MeNB may maintain the RRM measurement configuration of the UE and may, (for example, based on received measurement reports or traffic conditions or bearer types), decide to ask a SeNB to provide additional resources (serving cells) for a UE. Upon receiving a request from the MeNB, a SeNB may create a container that may result in the configuration of additional serving cells for the UE (or decide that it has no resource available to do so). For UE capability coordination, the MeNB may provide (part of) the AS configuration and the UE capabilities to the SeNB. The MeNB and the SeNB may exchange information about a UE configuration by employing RRC containers (inter-node messages) carried in X2 messages. The SeNB may initiate a reconfiguration of its existing serving cells (for example, a PUCCH towards the SeNB). The SeNB may decide which cell is the PSCell within the SCG. The MeNB may not change the content of the RRC configuration provided by the SeNB. In the case of a SCG addition and a SCG SCell addition, the MeNB may provide the latest measurement results for the SCG cell(s). Both a MeNB and a SeNB may know the SFN and subframe offset of each other by OAM, (for example, for the purpose of DRX alignment and identification of a measurement gap). In an example, when adding a new SCG SCell, dedicated RRC signaling may be used for sending required system information of the cell as for CA, except for the SFN acquired from a MIB of the PSCell of a SCG.

[0114] In an example, serving cells may be grouped in a TA group (TAG). Serving cells in one TAG may use the same timing reference. For a given TAG, user equipment (UE) may use at least one downlink carrier as a timing reference. For a given TAG, a UE may synchronize uplink subframe and frame transmission timing of uplink carriers belonging to the same TAG. In an example, serving cells having an uplink to which the same TA applies may correspond to serving cells hosted by the same receiver. A UE supporting multiple TAs may support two or more TA groups. One TA group may contain the PCell and may be called a primary TAG (pTAG). In a multiple TAG configuration, at least one TA group may not contain the PCell and may be called a secondary TAG (sTAG). In an example, carriers within the same TA group may use the same TA value and/or the same timing reference. When DC is configured, cells belonging to a cell group (MCG or SCG) may be grouped into multiple TAGs including a pTAG and one or more sTAGs.

[0115] FIG. 8 shows example TAG configurations as per an aspect of an embodiment of the present disclosure. In Example 1, pTAG comprises a PCell, and an sTAG comprises SCell1. In Example 2, a pTAG comprises a PCell and SCell1, and an sTAG comprises SCell2 and SCell3. In Example 3, pTAG comprises PCell and SCell1, and an sTAG1 includes SCell2 and SCell3, and sTAG2 comprises SCell4. Up to four TAGs may be supported in a cell group (MCG or SCG) and other example TAG configurations may also be provided. In various examples in this disclosure, example mechanisms are described for a pTAG and an sTAG. Some of the example mechanisms may be applied to configurations with multiple sTAGs.

[0116] In an example, an eNB may initiate an RA procedure via a PDCCH order for an activated SCell. This PDCCH order may be sent on a scheduling cell of this SCell. When cross carrier scheduling is configured for a cell, the scheduling cell may be different than the cell that is employed for preamble transmission, and the PDCCH order may include an SCell index. At least a non-contention based RA procedure may be supported for SCell(s) assigned to sTAG(s).

[0117] FIG. 9 is an example message flow in a random access process in a secondary TAG as per an aspect of an embodiment of the present disclosure. An eNB transmits an activation command 600 to activate an SCell. A preamble 602 (Msg1) may be sent by a UE in response to a PDCCH order 601 on an SCell belonging to an sTAG. In an example embodiment, preamble transmission for SCells may be controlled by the network using PDCCH format 1A. Msg2 message 603 (RAR: random access response) in response to the preamble transmission on the SCell may be addressed to RA-RNTI in a PCell common search space (CSS). Uplink packets 604 may be transmitted on the SCell in which the preamble was transmitted.

[0118] According to an embodiment, initial timing alignment may be achieved through a random access procedure. This may involve a UE transmitting a random access preamble and an eNB responding with an initial TA command NTA (amount of timing advance) within a random access response window. The start of the random access preamble may be aligned with the start of a corresponding uplink subframe at the UE assuming NTA=0. The eNB may estimate the uplink timing from the random access preamble transmitted by the UE. The TA command may be derived by

the eNB based on the estimation of the difference between the desired UL timing and the actual UL timing. The UE may determine the initial uplink transmission timing relative to the corresponding downlink of the sTAG on which the preamble is transmitted.

[0119] The mapping of a serving cell to a TAG may be configured by a serving eNB with RRC signaling. The mechanism for TAG configuration and reconfiguration may be based on RRC signaling. According to various aspects of an embodiment, when an eNB performs an SCell addition configuration, the related TAG configuration may be configured for the SCell. In an example embodiment, an eNB may modify the TAG configuration of an SCell by removing (releasing) the SCell and adding (configuring) a new SCell (with the same physical cell ID and frequency) with an updated TAG ID. The new SCell with the updated TAG ID may initially be inactive subsequent to being assigned the updated TAG ID. The eNB may activate the updated new SCell and start scheduling packets on the activated SCell. In an example implementation, it may not be possible to change the TAG associated with an SCell, but rather, the SCell may need to be removed and a new SCell may need to be added with another TAG. For example, if there is a need to move an SCell from an sTAG to a pTAG, at least one RRC message, (for example, at least one RRC reconfiguration message), may be sent to the UE to reconfigure TAG configurations by releasing the SCell and then configuring the SCell as a part of the pTAG. When an SCell is added/configured without a TAG index, the SCell may be explicitly assigned to the pTAG. The PCell may not change its TA group and may be a member of the pTAG.

[0120] The purpose of an RRC connection reconfiguration procedure may be to modify an RRC connection, (for example, to establish, modify and/or release RBs, to perform handover, to setup, modify, and/or release measurements, to add, modify, and/or release SCells). If the received RRC Connection Reconfiguration message includes the sCellToReleaseList, the UE may perform an SCell release. If the received RRC Connection Reconfiguration message includes the sCellToAddModList, the UE may perform SCell additions or modification.

[0121] In LTE Release-10 and Release-11 CA, a PUCCH may only be transmitted on the PCell (PSCell) to an eNB. In LTE-Release 12 and earlier, a UE may transmit PUCCH information on one cell (PCell or PSCell) to a given eNB.

[0122] As the number of CA capable UEs and also the number of aggregated carriers increase, the number of PUCCHs and also the PUCCH payload size may increase. Accommodating the PUCCH transmissions on the PCell may lead to a high PUCCH load on the PCell. A PUCCH on an SCell may be introduced to offload the PUCCH resource from the PCell. More than one PUCCH may be configured for example, a PUCCH on a PCell and another PUCCH on an SCell. In the example embodiments, one, two or more cells may be configured with PUCCH resources for transmitting CSI/ACK/NACK to a base station. Cells may be grouped into multiple PUCCH groups, and one or more cell within a group may be configured with a PUCCH. In an example configuration, one SCell may belong to one PUCCH group. SCells with a configured PUCCH transmitted to a base station may be called a PUCCH SCell, and a cell group with a common PUCCH resource transmitted to the same base station may be called a PUCCH group.

[0123] In an example embodiment, a MAC entity may have a configurable timer `timeAlignmentTimer` per TAG. The `timeAlignmentTimer` may be used to control how long the MAC entity considers the Serving Cells belonging to the associated TAG to be uplink time aligned. The MAC entity may, when a Timing Advance Command MAC control element is received, apply the Timing Advance Command for the indicated TAG; start or restart the `timeAlignmentTimer` associated with the indicated TAG. The MAC entity may, when a Timing Advance Command is received in a Random Access Response message for a serving cell belonging to a TAG and/or if the Random Access Preamble was not selected by the MAC entity, apply the Timing Advance Command for this TAG and start or restart the `timeAlignmentTimer` associated with this TAG. Otherwise, if the `timeAlignmentTimer` associated with this TAG is not running, the Timing Advance Command for this TAG may be applied and the `timeAlignmentTimer` associated with this TAG started. When the contention resolution is considered not successful, a `timeAlignmentTimer` associated with this TAG may be stopped. Otherwise, the MAC entity may ignore the received Timing Advance Command.

[0124] In example embodiments, a timer is running once it is started, until it is stopped or until it expires; otherwise it may not be running. A timer can be started if it is not running or restarted if it is running. For example, a timer may be started or restarted from its initial value.

[0125] Example embodiments of the disclosure may enable operation of multi-carrier communications. Other example embodiments may comprise a non-transitory tangible computer readable media comprising instructions executable by one or more processors to cause operation of multi-carrier communications. Yet other example embodiments may comprise an article of manufacture that comprises a non-transitory tangible computer readable machine-accessible medium having instructions encoded thereon for enabling programmable hardware to cause a device (e.g. wireless communicator, UE, base station, etc.) to enable operation of multi-carrier communications. The device may include processors, memory, interfaces, and/or the like. Other example embodiments may comprise communication networks comprising devices such as base stations, wireless devices (or user equipment: UE), servers, switches, antennas, and/or the like.

[0126] The amount of data traffic carried over cellular networks is expected to increase for many years to come. The number of users/devices is increasing and each user/device accesses an increasing number and variety of services, e.g. video delivery, large files, images. This may require not only high capacity in the network, but also provisioning very high data rates to meet customers' expectations on interactivity and responsiveness. More spectrum may therefore be needed for cellular operators to meet the increasing demand. Considering user expectations of high data rates along with seamless mobility, it may be beneficial that more spectrum be made available for deploying macro cells as well as small cells for cellular systems.

[0127] Striving to meet the market demands, there has been increasing interest from operators in deploying some complementary access utilizing unlicensed spectrum to meet the traffic growth. This is exemplified by the large number of operator-deployed Wi-Fi networks and the 3GPP standardization of LTE/WLAN interworking solutions. This interest indicates that unlicensed spectrum, when present,

may be an effective complement to licensed spectrum for cellular operators to help addressing the traffic explosion in some scenarios, such as hotspot areas. LAA may offer an alternative for operators to make use of unlicensed spectrum while managing one radio network, thus offering new possibilities for optimizing the network's efficiency.

[0128] In an example embodiment, Listen-before-talk (clear channel assessment) may be implemented for transmission in an LAA cell. In a listen-before-talk (LBT) procedure, equipment may apply a clear channel assessment (CCA) check before using the channel. For example, the CCA may utilize at least energy detection to determine the presence or absence of other signals on a channel in order to determine if a channel is occupied or clear, respectively. For example, European and Japanese regulations mandate the usage of LBT in the unlicensed bands. Apart from regulatory requirements, carrier sensing via LBT may be one way for fair sharing of the unlicensed spectrum.

[0129] In an example embodiment, discontinuous transmission on an unlicensed carrier with limited maximum transmission duration may be enabled. Some of these functions may be supported by one or more signals to be transmitted from the beginning of a discontinuous LAA downlink transmission. Channel reservation may be enabled by the transmission of signals, by an LAA node, after gaining channel access via a successful LBT operation, so that other nodes that receive the transmitted signal with energy above a certain threshold sense the channel to be occupied. Functions that may need to be supported by one or more signals for LAA operation with discontinuous downlink transmission may include one or more of the following: detection of the LAA downlink transmission (including cell identification) by UEs, time & frequency synchronization of UEs, and/or the like.

[0130] In an example embodiment, a DL LAA design may employ subframe boundary alignment according to LTE-A carrier aggregation timing relationships across serving cells aggregated by CA. This may not imply that the eNB transmissions can start only at the subframe boundary. LAA may support transmitting PDSCH when not all OFDM symbols are available for transmission in a subframe according to LBT. Delivery of necessary control information for the PDSCH may also be supported.

[0131] An LBT procedure may be employed for fair and friendly coexistence of LAA with other operators and technologies operating in an unlicensed spectrum. LBT procedures on a node attempting to transmit on a carrier in an unlicensed spectrum may require the node to perform a clear channel assessment to determine if the channel is free for use. An LBT procedure may involve at least energy detection to determine if the channel is being used. For example, regulatory requirements in some regions, for example, in Europe, may specify an energy detection threshold such that if a node receives energy greater than this threshold, the node assumes that the channel is not free. While nodes may follow such regulatory requirements, a node may optionally use a lower threshold for energy detection than that specified by regulatory requirements. In an example, LAA may employ a mechanism to adaptively change the energy detection threshold. For example, LAA may employ a mechanism to adaptively lower the energy detection threshold from an upper bound. Adaptation mechanism(s) may not preclude

static or semi-static setting of the threshold. In an example a Category 4 LBT mechanism or other type of LBT mechanisms may be implemented.

[0132] Various example LBT mechanisms may be implemented. In an example, for some signals, in some implementation scenarios, in some situations, and/or in some frequencies, no LBT procedure may be performed by the transmitting entity. In an example, Category 2 (for example, LBT without random back-off) may be implemented. The duration of time that the channel is sensed to be idle before the transmitting entity transmits may be deterministic. In an example, Category 3 (for example, LBT with random back-off with a contention window of fixed size) may be implemented. The LBT procedure may have the following procedure as one of its components. The transmitting entity may draw a random number N within a contention window. The size of the contention window may be specified by the minimum and maximum value of N . The size of the contention window may be fixed. The random number N may be employed in the LBT procedure to determine the duration of time that the channel is sensed to be idle before the transmitting entity transmits on the channel. In an example, Category 4 (for example, LBT with random back-off with a contention window of variable size) may be implemented. The transmitting entity may draw a random number N within a contention window. The size of the contention window may be specified by a minimum and maximum value of N . The transmitting entity may vary the size of the contention window when drawing the random number N . The random number N may be employed in the LBT procedure to determine the duration of time that the channel is sensed to be idle before the transmitting entity transmits on the channel.

[0133] LAA may employ uplink LBT at the UE. The UL LBT scheme may be different from the DL LBT scheme (for example, by using different LBT mechanisms or parameters), since the LAA UL may be based on scheduled access which affects a UE's channel contention opportunities. Other considerations motivating a different UL LBT scheme include, but are not limited to, multiplexing of multiple UEs in a single subframe.

[0134] In an example, a DL transmission burst may be a continuous transmission from a DL transmitting node with no transmission immediately before or after from the same node on the same CC. A UL transmission burst from a UE perspective may be a continuous transmission from a UE with no transmission immediately before or after from the same UE on the same CC. In an example, a UL transmission burst may be defined from a UE perspective. In an example, a UL transmission burst may be defined from an eNB perspective. In an example, in case of an eNB operating DL+UL LAA over the same unlicensed carrier, DL transmission burst(s) and UL transmission burst(s) on LAA may be scheduled in a TDM manner over the same unlicensed carrier. For example, an instant in time may be part of a DL transmission burst or an UL transmission burst.

[0135] In an example embodiment, in an unlicensed cell, a downlink burst may be started in a subframe. When an eNB accesses the channel, the eNB may transmit for a duration of one or more subframes. The duration may depend on a maximum configured burst duration in an eNB, the data available for transmission, and/or eNB scheduling algorithm. FIG. 10 shows an example downlink burst in an unlicensed (e.g. licensed assisted access) cell. The maxi-

um configured burst duration in the example embodiment may be configured in the eNB. An eNB may transmit the maximum configured burst duration to a UE employing an RRC configuration message.

[0136] The wireless device may receive from a base station at least one message (for example, an RRC) comprising configuration parameters of a plurality of cells. The plurality of cells may comprise at least one license cell and at least one unlicensed (for example, an LAA cell). The configuration parameters of a cell may, for example, comprise configuration parameters for physical channels, (for example, a ePDCCH, PDSCH, PUSCH, PUCCH and/or the like).

[0137] Frame structure type 3 may be applicable to an unlicensed (for example, LAA) secondary cell operation. In an example, frame structure type 3 may be implemented with normal cyclic prefix only. A radio frame may be $T_f=307200 \cdot T_s=10$ ms long and may comprise 20 slots of length $T_{slot}=15360 \cdot T_s=0.5$ ms, numbered from 0 to 19. A subframe i may be defined as two consecutive slots where subframe i comprises of slots $2i$ and $2i+1$. In an example, the 10 subframes within a radio frame may be available for downlink and/or uplink transmissions. Downlink transmissions may occupy one or more consecutive subframes, starting anywhere within a subframe and ending with the last subframe either fully occupied or following one of the DwPTS durations in a 3GPP Frame structure 2 (TDD frame). When an LAA cell is configured for uplink transmissions, frame structure 3 may be used for both uplink or downlink transmission.

[0138] An eNB may transmit one or more RRC messages to a wireless device (UE). The one or more RRC messages may comprise configuration parameters of a plurality of cells comprising one or more licensed cells and/or one or more unlicensed (for example, Licensed Assisted Access-LAA) cells. The one or more RRC messages may comprise configuration parameters for one or more unlicensed (for example, LAA) cells. An LAA cell may be configured for downlink and/or uplink transmissions.

[0139] In an example, the configuration parameters may comprise a first configuration field having a value of N for an LAA cell. The parameter N may be RRC configurable. N may be a cell specific or a UE specific RRC parameter. For example, N (for example, 6, 8, 16) may indicate a maximum number of HARQ processes that may be configured for UL transmissions. In an example, the RRC message may comprise an RNTI parameter for a multi-subframe DCI. In an example, one or more RRC messages may comprise configuration parameters of multi-subframe allocation parameters, maximum number of HARQ processes in the uplink, and/or other parameters associated with an LAA cell.

[0140] In an example, a UE may receive a downlink control information (DCI) indicating uplink resources (resource blocks for uplink grant) for uplink transmissions.

[0141] In an example embodiment, persistent (also called burst or multi-subframe) scheduling may be implemented. An eNB may schedule uplink transmissions by self scheduling and/or cross scheduling. In an example, an eNB may use UE C-RNTI for transmitting DCIs for multi-subframe grants. A UE may receive a multi-subframe DCI indicating uplink resources (resource blocks for uplink grant) for more than one consecutive uplink subframes (a burst), for example m subframes. In an example, a UE may transmit m subpackets (transport blocks-TBs), in response to the DCI

grant. FIG. 11 shows an example multi-subframe grant, LBT process, and multi-subframe transmission.

[0142] In an example embodiment, an uplink DCI may comprise one or more fields including uplink RBs, a power control command, an MCS, the number of consecutive subframes (m), and/or other parameters for the uplink grant. FIG. 15 shows example fields of a multi-subframe DCI grant.

[0143] In an example, a multi-subframe DCI may comprise one or more parameters indicating that a DCI grant is a multi-subframe grant. A field in a multi-subframe DCI may indicate the number of scheduled consecutive subframes (m). For example, a DCI for an uplink grant on an LAA cell may comprise a 3-bit field. The value indicated by the 3-bit field may indicate the number of subframes associated with the uplink DCI grant (other examples may comprise, for example, a 1-bit field or a 2-bit field). For example, a value 000 may indicate a dynamic grant for one subframe. For example, a field value 011 may indicate a DCI indicating uplink resources for 4 scheduled subframes (m =field value in binary +1). In an example, RRC configuration parameters may comprise a first configuration field having a value of N for an LAA cell. In an example implementation, the field value may be configured to be less than N . For example, N may be configured as 2, and a maximum number of scheduled subframes in a multi-subframe grant may be 2. In an example, N may be configured as 4 and a maximum number of scheduled subframes in a multi-subframe grant may be 4. In an example, N may be a number of configured HARQ processes in an UL. Successive subframes on a carrier may be allocated to a UE when the UE receives a multi-subframe UL DCI grant from an eNB.

[0144] At least one field included in a multi-subframe DCI may determine transmission parameters and resource blocks used across m consecutive subframes for transmission of one or more TBs. The DCI may comprise an assignment of a plurality of resource blocks for uplink transmissions. The UE may use the RBs indicated in the DCI across m subframes. The same resource blocks may be allocated to the UE in m subframes as shown in FIG. 11.

[0145] Asynchronous UL HARQ may be employed for UL HARQ operation(s). An uplink DCI grant may comprise a HARQ process number (HARQ ID). The uplink DCI may further comprise at least one redundancy version (RV) and/or at least one new data indicator (NDI). At least one new transmission and/or at least one retransmission may be scheduled by PDCCH DCI in LAA uplink HARQ transmissions. Example embodiments may comprise processes for granting resources calculating HARQ IDs and transmission parameters for one or more first TBs of HARQ Process(es).

[0146] A UE may perform listen before talk (LBT) before transmitting uplink signals. The UE may perform an LBT procedure indicating that a channel is clear for a starting subframe of the one or more consecutive uplink subframes. The UE may not perform a transmission at the starting subframe if the LBT procedure indicates that the channel is not clear for the starting subframe.

[0147] A TB transmission may be associated with a HARQ process. Multiple HARQ processes may be associated with TB transmissions in multiple subframes, for example, subframes $n, n+1, n+2, \dots, n+m-1$.

[0148] A field in the multi-subframe DCI may indicate the number of subframes (m) associated with the uplink grant. For example, a multi-subframe DCI for an uplink grant on

an LAA cell may comprise a 3-bit field, where a value indicated by the 3 bits may indicate the number of subframes associated with the grant (m =field value in binary +1). The DCI may further comprise a HARQ process number (HARQ ID: h). In an example, when the HARQ ID in the DCI grant indicates HARQ process ID= h and the 3-bit field (m) is "000," the DCI may indicate a dynamic grant for one subframe and for HARQ ID= h . In an example, when HARQ ID= h and m is "011" ($m=4$), the DCI may indicate that the grant is also valid for subframes $n+1, n+2$ and $n+3$ for HARQ processes $(h+1) \text{ Mod } N, (h+2) \text{ Mod } N$ and $(h+3) \text{ Mod } N$, respectively. N may be a preconfigured number, for example, $N=8$ or 16. Mod is a modulo function. For example, N may be a number of configured HARQ processes. For example, when $m=4$, and $h=3$, and $N=16$, then HARQ process IDs may be 3, 4, 5, and 6, respectively for subframes $n, n+1, n+2$, and $n+3$, where the multi-subframe grant is associated with subframes $n, n+1, n+2$, and $n+3$.

[0149] FIG. 12 shows an example for $m=3$, and HARQ ID= h . HARQ ID for subframes $n, n+1$, and $n+2$ may be $h \text{ mod } N, (h+1) \text{ mod } N$, and $(h+2) \text{ mod } N$. For example when $h=1$, and $N=8$, then $h \text{ mod } N=h=1, (h+1) \text{ mod } N=h+1=2$, and $(h+2) \text{ mod } N=h+2=3$.

[0150] The UE may apply a multi-subframe grant to m HARQ processes. HARQ process ID may be incremented and rounded to modulo N : $(\text{HARQ_ID}+i) \text{ modulo } N$. A first HARQ ID for a first subframe i in a multi-subframe burst may be calculated as: (the HARQ ID plus i) modulo a first pre-configured number. The parameter i may indicate a subframe position of the first subframe in the one or more consecutive uplink subframes. The parameter i may have a value of zero for a starting subframe. The parameter i may have a value of the number minus one ($m-1$) for an ending subframe. In an example, N may be a preconfigured number.

[0151] A DCI grant may comprise at least one redundancy version (RV), and at least one new data indicator (NDI). In an example, multi-subframe resource allocation may be applicable to uplink grants for a first TB (for example, first transmission) of one or more HARQ process.

[0152] In an example, for a LAA SCell, and transmission mode 1, there may be 16 uplink HARQ processes. For a LAA SCell, and transmission mode 2, there may be 32 uplink HARQ processes. In an example embodiment, for a serving cell that is an LAA SCell, a UE may upon detection of an PDCCH/EPDCCH with a multi-subframe uplink DCI grant for subframes starting subframe n , may perform a corresponding PUSCH transmission, conditioned on a successful LBT procedure, in subframe(s) $n+i$ with $i=0, 1, \dots, m-1$ according to the PDCCH/EPDCCH and HARQ process ID $\text{mod } (n_{\text{HARQ_ID}}+i, N_{\text{HARQ}})$. Mod may be a module function. The value of m may be determined by the number of scheduled subframes field in the corresponding multi-subframe grant DCI format. The UE may be configured with a maximum value of m by an RRC parameter in the at least one RRC message. The value of $n_{\text{HARQ_ID}}$ may be determined by the HARQ process number field in the corresponding multi-subframe uplink DCI format. In an example, N_{HARQ} may be 16.

[0153] An example embodiment for calculating HARQ ID(s) may reduce the DCI size and reduce downlink control overhead. Instead of transmitting multiple HARQ IDs for multiple subframes, one HARQ ID may be included in the DCI for multiple subframes. Example embodiments provide a simple and efficient mechanism for calculating a HARQ ID

for each subframe in a multi-subframe grant, when HARQ ID has an upper limit. Example embodiments may increase spectral efficiency, reduce downlink control overhead, and simplify UE processing related to HARQ processes.

[0154] In an example, one or more HARQ re-transmissions (if any) may be dynamically scheduled by the eNB employing uplink grant DCIs for one or more retransmissions. In an example embodiment, dynamic scheduling may be implemented. A UE may transmit in a subframe on a carrier if it receives an UL grant for that subframe.

[0155] In an example, when a UE receives a new UL DCI grant for a first transmission of one or more first TBs during applicability of a prior DCI grant (for example, multi-subframe DCI) on an LAA cell, the new DCI grant may override the old one. An example is shown in FIG. 14. Second DCI may be considered for uplink transmissions on subframe n+1, and may override the first DCI for subframe n+1.

[0156] An example embodiment for DCI processing may enable an eNB to transmit updated DCIs to over-ride previous DCIs when needed. This may enable an eNB and a UE to adjust and adapt to an updated scheduling in different scenarios depending on link parameters, HARQ transmissions, and LBT success or failure. This process may be employed to improve scheduling efficiency for an LAA cell.

[0157] In an example, a wireless device may receive, in a first subframe, a first multi-subframe DCI indicating first uplink resources for the LAA cell. The first DCI being for a number of one or more consecutive uplink subframes comprising a third subframe. The wireless device may receive, in a second subframe different from the first subframe, a second DCI indicating second uplink resources for the third subframe. In an example, a new grant may override the old one. The wireless device may transmit, via a plurality of resource blocks in the third subframe, one or more transport blocks according to parameters of the most recently received first DCI or second DCI.

[0158] In an example embodiment, in order to transmit on the UL-SCH, the MAC entity may have a valid uplink grant which it may receive dynamically on the (E)PDCCH or in a Random Access Response. To perform requested transmissions, the MAC layer may receive HARQ information from lower layers. When the physical layer is configured for uplink spatial multiplexing, the MAC layer may receive up to two grants (one per HARQ process) for the same TTI from lower layers.

[0159] There may be one HARQ entity at a MAC entity for a Serving Cell with a configured uplink, which may maintain a number of parallel HARQ processes allowing transmissions to take place continuously while waiting for the HARQ feedback on the successful or unsuccessful reception of previous transmissions. The number of parallel HARQ processes per HARQ entity may depend on UE capability(ies), for example, it may be 4, 6, 8, 16 or 32. In an example, when the physical layer is configured for uplink spatial multiplexing, there may be two HARQ processes associated with a given TT, otherwise there may be one HARQ process associated with a given TTI.

[0160] At a given TTI, if an uplink grant is indicated for the TTI, the HARQ entity may identify the HARQ process(es) for which a transmission may take place. The HARQ entity may route the received HARQ feedback (ACK/NACK information), MCS and resource, relayed by the physical layer, to appropriate HARQ process(es).

[0161] A HARQ process may be associated with a HARQ buffer. A HARQ process may maintain a state variable CURRENT_TX_NB, which indicates the number of transmissions that have taken place for the MAC PDU currently in the buffer, and a state variable HARQ_FEEDBACK, which indicates the HARQ feedback for the MAC PDU currently in the buffer. When the HARQ process is established, CURRENT_TX_NB may be initialized to 0.

[0162] The sequence of redundancy versions may be 0, 2, 3, and/or 1. A variable CURRENT_IRV may comprise an index into the sequence of redundancy versions. In an example implementation, this variable may be an up-dated modulo 4.

[0163] New transmissions may be performed on the resource and with the MCS indicated on (E)PDCCH or Random Access Response. Adaptive retransmissions may be performed on the resource and, if provided, with the MCS indicated on (E)PDCCH. Non-adaptive retransmission may be performed on the same resource and with the same MCS as was used for the last made transmission attempt.

[0164] An Uplink HARQ operation may be asynchronous for serving cells operating according to Frame Structure Type 3 (for example, LAA cells).

[0165] In a non-adaptive UL HARQ process, the MAC entity may be configured with a Maximum number of HARQ transmissions and a Maximum number of Msg3 HARQ transmissions by RRC: maxHARQ-Tx and max-HARQ-Msg3Tx respectively. For transmissions on HARQ processes and logical channels except for transmission of a MAC PDU stored in the Msg3 buffer, the maximum number of transmissions may be set to maxHARQ-Tx. For transmission of a MAC PDU stored in the Msg3 buffer, the maximum number of transmissions may be set to max-HARQ-Msg3Tx.

[0166] In an example embodiment, a MAC entity may perform the following process. In a TTI, the HARQ entity may: identify the HARQ process(es) associated with the TTI, and for an identified HARQ process may perform the following process. If an uplink grant has been indicated for the process and the TTI: if the received grant was not addressed to a Temporary C-RNTI on (E)PDCCH and if the NDI provided in the associated HARQ information has been toggled compared to the value in the previous transmission of the HARQ process; or if the uplink grant was received on (E)PDCCH for the C-RNTI and the HARQ buffer of the identified process is empty; or if the uplink grant was received in a Random Access Response, the MAC may perform the following actions. If there is a MAC PDU in the Msg3 buffer and the uplink grant was received in a Random Access Response: obtain the MAC PDU to transmit from the Msg3 buffer. Else, obtain the MAC PDU to transmit from the "Multiplexing and assembly" entity; deliver the MAC PDU and the uplink grant and the HARQ information to the identified HARQ process; and instruct the identified HARQ process to trigger a new transmission. Otherwise, the MAC may perform the following: deliver the uplink grant and the HARQ information (redundancy version) to the identified HARQ process; and instruct the identified HARQ process to generate an adaptive retransmission.

[0167] If an uplink grant has not been indicated for the process and the TTI: if the HARQ buffer of this HARQ process is not empty: instruct the identified HARQ process to generate a non-adaptive retransmission.

[0168] When determining if NDI has been toggled compared to the value in the previous transmission, the MAC entity may ignore NDI received in an uplink grant on (E)PDCCH for its Temporary C-RNTI. In an example embodiment, the above process may be for a licensed cell.

[0169] In an example embodiment, when the HARQ feedback is received for this TB, the HARQ process in a MAC entity may: set HARQ_FEEDBACK to the received value.

[0170] If the HARQ entity requests a new transmission, the HARQ process may perform: set CURRENT_TX_NB to 0; set CURRENT_IRV to 0; store the MAC PDU in the associated HARQ buffer; store the uplink grant received from the HARQ entity; set HARQ_FEEDBACK to NACK; and/or generate a transmission as described below, and/or a combination of these tasks.

[0171] If the HARQ entity requests a retransmission, the HARQ process may: increment CURRENT_TX_NB by 1; if the HARQ entity requests an adaptive retransmission: store the uplink grant received from the HARQ entity; set CURRENT_IRV to the index corresponding to the redundancy version value provided in the HARQ information; set HARQ_FEEDBACK to NACK; generate a transmission as described below. Else, if the HARQ entity requests a non-adaptive retransmission: if HARQ_FEEDBACK=NACK: generate a transmission as described below.

[0172] When receiving a HARQ ACK alone, the MAC entity may keep the data in the HARQ buffer. When no UL-SCH transmission can be made due to the occurrence of a measurement gap, no HARQ feedback may be received and a non-adaptive retransmission may follow.

[0173] To generate a transmission, the HARQ process may: if the MAC PDU was obtained from the Msg3 buffer; or if there is no measurement gap at the time of the transmission and, in case of retransmission, the retransmission does not collide with a transmission for a MAC PDU obtained from the Msg3 buffer in the TTI: instruct the physical layer to generate a transmission according to the stored uplink grant with the redundancy version corresponding to the CURRENT_IRV value; increment CURRENT_IRV by 1; and if there is a measurement gap at the time of the HARQ feedback reception for this transmission and if the MAC PDU was not obtained from the Msg3 buffer: set HARQ_FEEDBACK to ACK at the time of the HARQ feedback reception for the transmission.

[0174] After performing the above actions, when a HARQ maximum number of transmissions is configured, the HARQ process may: if CURRENT_TX_NB=maximum number of transmissions-1, flush the HARQ buffer.

[0175] An asynchronous HARQ may be implemented for UL HARQ for an unlicensed cell. The scheduler at the eNB may schedule UL transmissions and retransmissions. Transmissions or retransmissions may be scheduled via (E)PDCCH. Implementation of mechanisms implemented in legacy uplink synchronous HARQ for unlicensed cells adopting an asynchronous HARQ may result in many issues. Example embodiments may enhance implementation of asynchronous uplink HARQ.

[0176] In an example embodiment, a wireless device may receive one or more radio resource control (RRC) messages comprising configuration parameters for a licensed assisted access (LAA) cell. The one or more RRC messages may comprise one or more consecutive uplink subframe allocation configuration parameters. In an example, the one or more consecutive uplink subframe allocation configuration parameters comprises a first field, N.

[0177] A wireless device may receive a downlink control information (DCI) indicating uplink resources in a number of one or more consecutive uplink subframes of the LAA cell. The DCI may comprise: the number of the one or more

consecutive uplink subframes (m); an assignment of a plurality of resource blocks; and a transmit power control command. The first field may indicate an upper limit for the number of the one or more consecutive uplink subframes.

[0178] The wireless device may perform a listen before talk procedure indicating that a channel is clear for a starting subframe of the one or more consecutive uplink subframes. The wireless device may transmit one or more transport blocks, via the plurality of resource blocks used across the one or more consecutive uplink subframes. At least one field included in a multi-subframe DCI may determine transmission parameters and resource blocks used across m consecutive subframes for transmission of one or more TBs. The DCI may comprise an assignment of a plurality of resource blocks for uplink transmissions. The UE may use the RBs indicated in the DCI across m subframes. The same resource blocks may be allocated to the UE in m subframes.

[0179] A transmission power of the one or more transport blocks in each subframe of the one or more consecutive uplink subframes may employ the transmit power control (TPC) command in the multi-subframe DCI. A transmission power of the one or more transport blocks in each subframe of the one or more consecutive uplink subframes may be adjusted in each subframe when a total transmit power in each subframe exceeds a power value in each subframe. The power value may be an allowed maximum transmission power of the wireless device. A calculation of the transmission power may employ a measured pathloss value. The transmission power of the one or more transport blocks in each subframe of the one or more consecutive uplink subframes may employ the same closed loop adjustment factor (calculated employing, at least, the TPC in multi-subframe DCI). The closed loop adjustment factor may be calculated employing the transmit power control command

[0180] An UL grant for subframe n sent by an eNB, for example, on subframe n-4, may comprise a power control command from eNB for UE to adjust its uplink transmission power for transmission of a signal, for example, PUSCH, SRS, etc on an uplink of an LAA SCell. A UE may calculate a transmit power considering a power control command received from the eNB. Enhanced power control mechanisms may be implemented for uplink transmission when an eNB transmits a multi-subframe UL grant applicable to multiple subframes.

[0181] In an example embodiment, a UE may receive a multi-subframe uplink DCI grant comprising a TPC for one or more consecutive subframes starting from subframe n. The UE may calculate uplink transmit power for subframe n based on the TPC command and other power parameters as described in PUSCH/SRS power calculation mechanism. This may be considered a baseline power for transmission on subframes associated with the multi-subframe uplink grant. The UE may apply the same baseline power to subframes associated with the multi-subframe grant. For example, TPC command may be employed to calculate a closed loop adjustment factor (f(i)) for subframe i. The same closed loop adjustment factor may be employed for subframes in the one or more consecutive subframes associated with the multi-subframe uplink grant.

[0182] In an example, for subframe i in one or more consecutive subframes, $f(n)=f(n-1)+TPC$, when accumulation is enabled and where the TPC is the transmit power control received in the multi-subframe grant. f(n) may be calculated for subframe n (the starting subframe in the one or more subsequent subframes) and may be applied to all subframes in the one or more consecutive subframes. This implies that $f(n)=f(n-1)+TPC$ for the starting subframe in the one or more consecutive subframes, and $f(i)=f(i-1)$ for

subsequent subframes, where $i > n$ and subframe i is one of the subsequent subframes in the one or more consecutive subframes.

[0183] In an example, for subframe n in one or more consecutive subframes, $f(n)$ may equal TPC when accumulation is not enabled and where the TPC comprises the transmit power control received in the multi-subframe grant. $f(n)$ may be calculated for subframe n (the starting subframe in the one or more subsequent subframes) and may be applied to all subframes in the one or more consecutive subframes. This may imply that $f(i) = \text{TPC}$ for each subframe i in the one or more consecutive subframes.

[0184] An example embodiment for a multi-subframe grant may reduce downlink control overhead by including one TPC field and one RB resource assignment field in a multi-subframe grant for multiple subframes. Example embodiments provide a flexible method for resource assignment and power calculations for multiple subframes. An example embodiment may reduce overhead control signaling for resource block assignment(s). An example embodiment reduces overhead control signaling for TPC transmission while maintaining flexibility for each subframe power calculation. Although one TPC field is transmitted in a multi-subframe DCI grant, power calculation(s) may be performed for each subframe separately. A wireless device may have different transmit power values for different subframes (of an LAA cell) associated with a multiple-subframe grant, while using the same TPC field. Calculating the same power value for multiple subframes may introduce unnecessary constraints which may reduce uplink transmission efficiency in some scenarios. Example embodiments may reduce downlink control overhead while providing flexibility for separate transmit power calculations for each subframe when needed.

[0185] The UE may adjust the UE signal transmit power when needed based on maximum allowed transmit power limitation of a UE in a subframe. For example, if multi-subframe grant is applicable to subframes n , $n+1$ and $n+2$, a UE may calculate a baseline power for the uplink transmission of PUSCH. In subframes n , $n+1$, and $n+2$, the UE may or may not adjust the transmit power depending on power limitations in the subframe. The UE may adjust (when needed) the transmit power in each subframe so that the total transmit power in each subframe is below a maximum allowed transmit power of the UE in each subframe. In the example illustrated in FIG. 13A, LAA PUSCH may be adjusted differently in each subframe due to power limitations in subframes n , $n+1$, and $n+2$. When a calculated total power exceeds a threshold in a subframe, the UE may adjust PUSCH transmit power in the subframe. The calculated power may be for licensed cell(s) and/or unlicensed cell(s). In the example illustrated in FIG. 13B, the power may not be adjusted due to power limitations and pathloss is the same across subframes. The UE may maintain the same transmit power for PUSCH transmission of the LAA cell across subframes.

[0186] In an example embodiment, a UE may calculate uplink transmit power for subframe n based on a TPC command in the UL grant and other power parameters as described in PUSCH power calculation mechanism. The UE may calculate uplink transmit power on subframe $n+1$ based on TPC command on UL grant and other power parameters as described in PUSCH power calculation mechanism. The UE may employ the same closed loop adjustment factor ($f(i)$) as the baseline for all the subframes in the one or more subsequent subframes.

[0187] The UE may apply adjustments, if needed, to compensate for changes in measured pathloss reference (for example, using a configured moving average equation, or

based on a measured value). The transmit power may be recalculated in a subframe when the pathloss has changed in the subframe. The UE may also adjust the UE signal transmit power, if needed, based on a maximum allowed transmit power limitation of a UE in each subframe. For example, if a multi-subframe grant is applicable for subframes n , $n+1$ and $n+2$, a UE may calculate a baseline power for the uplink transmission of PUSCH. In subframes n , $n+1$, and $n+2$, the UE may or may not adjust the transmit power depending on whether the pathloss reference measurement is changed. The UE may or may not adjust the transmit power depending on power limitations in the subframe. The UE may adjust (when needed) the transmit power in a subframe so that the total transmit power in a subframe is below a maximum allowed transmit power of the UE in the subframe.

[0188] In an example embodiment, one or more RRC messages configuring the LAA cell may indicate whether a single baseline power is calculated for subframes or whether each subframe may have its own calculated power (for example, based on pathloss reference value, etc). Power adjustments due to UE maximum allowed power may be applicable to a subframe, when needed.

[0189] Uplink power control may control a transmit power of the different uplink physical channels. In an example, the setting of the UE Transmit power for a Physical Uplink Shared Channel (PUSCH) transmission may be defined as follows. If the UE transmits PUSCH without a simultaneous PUCCH for the serving cell c , then the UE transmit power $P_{PUSCH,c}(i)$ for PUSCH transmission in subframe i for the serving cell c may be given by

$$P_{PUSCH,c}(i) = \min \left\{ \begin{array}{l} P_{CMAX,c}(i), \\ 10 \log_{10}(M_{PUSCH,c}(i) + P_{O_PUSCH,c}(j) + \alpha_c(j) \cdot PL_c + \Delta_{TF,c}(i) + f_c(i)) \end{array} \right\} \quad [dBm]$$

[0190] If the UE transmits PUSCH simultaneous with PUCCH for the serving cell c , then the UE transmit power $P_{PUSCH,c}(i)$ for the PUSCH transmission in subframe i for the serving cell c may be given by

$$P_{PUSCH,c}(i) = \min \left\{ \begin{array}{l} 10 \log_{10}(\hat{P}_{CMAX,c}(i) - \hat{P}_{PUCCH}(i)) \\ 10 \log_{10}(M_{PUSCH,c}(i) + P_{O_PUSCH,c}(j) + \alpha_c(j) \cdot PL_c + \Delta_{TF,c}(i) + f_c(i)) \end{array} \right\} \quad [dBm]$$

[0191] If the UE is not transmitting PUSCH for the serving cell c , for the accumulation of TPC command received with DCI format 3/3A for PUSCH, the UE may assume that the UE transmit power $P_{PUSCH,c}(i)$ for the PUSCH transmission in subframe i for the serving cell c is computed by

$$P_{PUSCH,c}(i) = \min \{ P_{CMAX,c}(j), P_{O_PUSCH,c}(1) + \alpha_c(1) \cdot PL_c + f_c(i) \} \quad [dBm]$$

where, $P_{CMAX,c}(i)$ may be a configured UE transmit power in subframe i for serving cell c and $\hat{P}_{CMAX,c}(i)$ may be the linear value of $P_{CMAX,c}(i)$. $\hat{P}_{PUCCH}(i)$ may be the linear value of $P_{PUCCH}(i)$. $M_{PUSCH,c}(i)$ may be the bandwidth of the

PUSCH resource assignment expressed in number of resource blocks valid for subframe i and serving cell c . Further description of some of the parameters in a power control formula may be defined according to the latest LTE-Advanced standard specifications (for example, 3GPP TS 36.213). PL_c may be the downlink path loss estimate calculated in the UE for serving cell c in dB.

[0192] $\delta_{PUSCH,c}$ may be a correction value, also referred to as a TPC command and may be included in PDCCH/EPDCCH with DCI format comprising a corresponding TPC. In an example, if the UE is configured with higher layer parameter UplinkPowerControlDedicated-v12x0 for serving cell c and if subframe i belongs to uplink power control subframe set 2 as indicated by the higher layer parameter tpc-SubframeSet-r12, the current PUSCH power control adjustment state for serving cell c is given by $f_{c,2}(i)$, and the UE shall use $f_{c,2}(i)$ instead of $f_c(i)$ to determine $P_{PUSCH,c}(i)$. Otherwise, the current PUSCH power control adjustment state for serving cell c is given by $f_c(i)$. $f_{c,2}(i)$ and $f_c(i)$ may be defined by the following example formulas.

[0193] $f_c(i) = f_c(i-1) + \delta_{PUSCH,c}(i - K_{PUSCH})$ and $f_{c,2}(i) = f_{c,2}(i-1) + \delta_{PUSCH,c}(i - K_{PUSCH})$ if accumulation is enabled based on the parameter Accumulation-enabled provided by higher layers (for example, in RRC message). where $\delta_{PUSCH,c}(i - K_{PUSCH})$ may be signalled on PDCCH/EPDCCH with DCI format on subframe $i - K_{PUSCH}$, and where $f_c(0)$ is the first value after reset of accumulation. For example, the value of K_{PUSCH} is for FDD or FDD-TDD and serving cell frame structure type 1, $K_{PUSCH} = 4$. For a serving cell with frame structure type 3, subframe $i - K_{PUSCH}$ comprises the DCI comprising TPC for subframe i , based on uplink grant format and grant timing. $\delta_{PUSCH,c} = 0$ dB for a subframe where no TPC command is decoded for serving cell c or where DRX occurs or i is not an uplink subframe in TDD or FDD-TDD and serving cell c frame structure type 2. In an example, $\delta_{PUSCH,c} = 0$ dB if the subframe i is not the starting subframe scheduled by a PDCCH/EPDCCH of a multi-subframe uplink DCI grant. In an example, if UE has reached $P_{CMAX,c}(i)$ for serving cell c , positive TPC commands for serving cell c shall not be accumulated. In an example, if a UE has reached minimum power, negative TPC commands shall not be accumulated.

[0194] In an example embodiment, $f_c(i) = \delta_{PUSCH,c}(i - K_{PUSCH})$ and $f_{c,2}(i) = \delta_{PUSCH,c}(i - K_{PUSCH})$ if accumulation is not enabled for serving cell c based on the parameter Accumulation-enabled provided by higher layers (for example, RRC layer). $\delta_{PUSCH,c}(i - K_{PUSCH})$ is the TPC command received for subframe i .

[0195] In an example embodiment, if the UE is not configured with an SCG or a PUCCH-SCell, and if the total transmit power of the UE would exceed $\hat{P}_{CMAX}(i)$, the UE may scale $\hat{P}_{PUSCH,c}(i)$ for the serving cell c in subframe i such that the condition

$$\sum_c w(i) \cdot \hat{P}_{PUSCH,c}(i) \leq (\hat{P}_{CMAX}(i) - \hat{P}_{PUCCH}(i))$$

is satisfied where $\hat{P}_{PUCCH}(i)$ may be the linear value of $P_{PUCCH}(i)$, $\hat{P}_{PUSCH,c}(i)$ may be the linear value of $P_{PUSCH,c}(i)$, $\hat{P}_{CMAX}(i)$ may be the linear value of the UE total configured maximum output power P_{CMAX} in subframe i and $w(i)$ may be a scaling factor of $\hat{P}_{PUSCH,c}(i)$ for serving cell c where $0 \leq w(i) \leq 1$. In case there is no PUCCH transmission in subframe i $\hat{P}_{PUCCH}(i) = 0$. If the UE is not configured with an SCG or a PUCCH-SCell, and if the UE has PUSCH transmission with UCI on serving cell j and PUSCH without UCI in any of the remaining serving cells, and the total

transmit power of the UE would exceed $\hat{P}_{CMAX}(i)$, the UE may scale $\hat{P}_{PUSCH,c}(i)$ for the serving cells without UCI in subframe i such that the condition

$$\sum_{c \neq j} w(i) \cdot \hat{P}_{PUSCH,c}(i) \leq (\hat{P}_{CMAX}(i) - \hat{P}_{PUSCH,j}(i))$$

is satisfied where $\hat{P}_{PUSCH,j}(i)$ is the PUSCH transmit power for the cell with UCI and $w(i)$ is a scaling factor of $\hat{P}_{PUSCH,c}(i)$ for serving cell c without UCI. In this case, no power scaling may be applied to $\hat{P}_{PUSCH,j}(i)$ unless

$$\sum_{c \neq j} w(i) \cdot \hat{P}_{PUSCH,c}(i) = 0$$

and the total transmit power of the UE still would exceed $\hat{P}_{CMAX}(i)$.

[0196] For a UE not configured with a SCG or a PUCCH-SCell, note that $w(i)$ values may be the same across serving cells when $w(i) > 0$ but for certain serving cells $w(i)$ may be zero. If the UE is not configured with an SCG or a PUCCH-SCell, and if the UE has simultaneous PUCCH and PUSCH transmission with UCI on serving cell j and PUSCH transmission without UCI in any of the remaining serving cells, and the total transmit power of the UE would exceed $\hat{P}_{CMAX}(i)$, the UE may obtain $\hat{P}_{PUSCH,c}(i)$ according to

$$\hat{P}_{PUSCH,j}(i) = \min(\hat{P}_{PUSCH,j}(i), (\hat{P}_{CMAX}(i) - \hat{P}_{PUCCH}(i)))$$

and

$$\sum_{c \neq j} w(i) \cdot \hat{P}_{PUSCH,c}(i) \leq (\hat{P}_{CMAX}(i) - \hat{P}_{PUCCH}(i) - \hat{P}_{PUSCH,j}(i))$$

[0197] In an example embodiment, if the UE is configured with a LAA SCell for uplink transmissions, the UE may compute the scaling factor $w(i)$ assuming that the UE performs a PUSCH transmission on the LAA SCell in subframe i irrespective of whether the UE can access the LAA SCell for the PUSCH transmission in subframe i according to the channel access procedures.

[0198] The latest standard documents 3GPP TS 36.211, 36.212, 36.212, 36.302 and 36.331 of V13.0 describe SRS and PUSCH processes.

[0199] According to release 13 of the LTE standard, PUSCH resource mapping in a subframe are done considering cell-specific SRS configuration and UE-specific SRS transmission in the uplink.

[0200] 3GPP TS 36.211 v13.0 discloses that for an antenna port p used for transmission of the PUSCH in a subframe the block of complex-valued symbols $z^{(p)}(0), \dots, z^{(p)}(M_{\text{symbol}}^{ap} - 1)$ may be multiplied with the amplitude scaling factor β_{PUSCH} in order to conform to the transmit power of P_{PUSCH} and may be mapped in sequence starting with $z^{(p)(0)}$ to physical resource blocks on antenna port p and assigned for transmission of PUSCH. The relation between the index \tilde{p} and the antenna port number p may be specified. The mapping to resource elements (k,l) corresponding to the physical resource blocks assigned for transmission and not used for transmission of reference signals, and not part of the

last SC-FDMA symbol in a subframe, if the UE transmits SRS in the same subframe in the same serving cell, and not part of the last SC-FDMA symbol in a subframe configured with cell-specific SRS, if the PUSCH transmission partly or fully overlaps with the cell-specific SRS bandwidth, and not part of an SC-FDMA symbol reserved for possible SRS transmission in a UE-specific aperiodic SRS subframe in the same serving cell, and not part of an SC-FDMA symbol reserved for possible SRS transmission in a UE-specific periodic SRS subframe in the same serving cell when the UE is configured with multiple TAGs may be in increasing order of first the index k, then the index l, starting with the first slot in the subframe.

[0201] In the current PUSCH resource mapping, coding and/or modulation, mechanism may not be efficient for uplink transmissions. The current implementation may introduce issues for uplink transmission in LAA cells. UL-SCH coding mechanisms implemented for LTE technology may reduce uplink spectral efficiency. Example embodiment of the invention increase uplink spectral efficiency in the uplink transmission, for example, for PUSCH and/or SRS.

[0202] In Release 13, UL-SCH Code blocks may delivered to the channel coding block. The bits in a code block may denoted by $c_{r,0}, c_{r,1}, c_{r,2}, c_{r,3}, \dots, c_{r(K_r-1)}$, where r is the code block number, and K_r is the number of bits in code block number r. The total number of code blocks may be denoted by C and a code block is individually turbo encoded. In an example, after encoding the bits are denoted by $d_{r,0}^{(i)}, d_{r,1}^{(i)}, d_{r,2}^{(i)}, d_{r,3}^{(i)}, \dots, d_{r(D_r-1)}^{(i)}$, with $i=0, 1$, and 2 and where D_r is the number of bits on the i-th coded stream for code block number r, i.e. $D_r=K_r+4$

[0203] Turbo coded blocks may be delivered to the rate matching block. They are denoted by $d_{r,0}^{(i)}, d_{r,1}^{(i)}, d_{r,2}^{(i)}, d_{r,3}^{(i)}, \dots, d_{r(D_r-1)}^{(i)}$, with $i=0, 1$, and 2, and where r is the code block number, i is the coded stream index, and D_r is the number of bits in each coded stream of code block number r. The total number of code blocks may be denoted by C and each coded block is individually rate matched. After rate matching, the bits are denoted by $e_{r,0}, e_{r,1}, e_{r,2}, e_{r,3}, \dots, e_{r(E_r-1)}$, where r is the coded block number, and where E_r is the number of rate matched bits for code block number r.

[0204] The bits input to the code block concatenation block may be denoted by $e_{r,0}, e_{r,1}, e_{r,2}, e_{r,3}, \dots, e_{r(E_r-1)}$ for $r=0, \dots, C-1$ and where E_r is the number of rate matched bits for the r-th code block. Code block concatenation is performed in release 13 LTE devices. The bits after code block concatenation are denoted by $f_0, f_1, f_2, f_3, \dots, f_{G-1}$, where G is the total number of coded bits for transmission of the given transport block over N_L transmission layers excluding the bits used for control transmission, when control information is multiplexed with the UL-SCH transmission.

[0205] Control data may arrive at the coding unit in the form of channel quality information (CQI and/or PMI), HARQ-ACK and rank indication, and CSI-RS resource indication (CRI). Different coding rates for the control information are achieved by allocating different number of coded symbols for its transmission. When control data are transmitted in the PUSCH, the channel coding for HARQ-ACK, rank indication, CRI and channel quality information $o_0, o_1, o_2, \dots, o_{O-1}$ is done independently. For the cases with TDD primary cell, the number of HARQ-ACK bits is determined according to a predefined mechanism.

[0206] When the UE transmits HARQ-ACK bits, rank indicator bits or CRI bits, it may determine the number of coded modulation symbols per layer Q' for HARQ-ACK, rank indicator or CRI bits as follows.

[0207] In an example implementation, for the case when one transport block is transmitted in the PUSCH conveying the HARQ-ACK bits, rank indicator bits or CRI bits:

$$Q' = \min \left(\left\lceil \frac{O \cdot M_{sc}^{PUSCH-initial} \cdot N_{symb}^{PUSCH-initial} \cdot \beta_{offset}^{PUSCH}}{\sum_{r=0}^{C-1} K_r} \right\rceil, 4 \cdot M_{sc}^{PUSCH} \right)$$

[0208] where O is the number of HARQ-ACK bits, rank indicator bits or CRI bits, and M_{sc}^{PUSCH} is the scheduled bandwidth for PUSCH transmission in the current sub-frame for the transport block, expressed as a number of subcarriers, and $N_{symb}^{PUSCH-initial}$ is the number of SC-FDMA symbols per subframe for initial PUSCH transmission for the same transport block, respectively, given by $N_{symb}^{PUSCH-initial} = (2 \cdot (N_{symb}^{UL} - 1) - N_{SRS})$, where is equal to 1. If UE configured with one UL cell is configured to send PUSCH and SRS in the same subframe for initial transmission, or if UE transmits PUSCH and SRS in the same subframe in the same serving cell for initial transmission, or if the PUSCH resource allocation for initial transmission even partially overlaps with the cell-specific SRS subframe and bandwidth configuration, or if the subframe for initial transmission in the same serving cell is a UE-specific type-1 SRS subframe, or if the subframe for initial transmission in the same serving cell is a UE-specific type-0 SRS subframe and the UE is configured with multiple TAGs. Otherwise N_{SRS} is equal to 0.

[0209] $M_{sc}^{PUSCH-initial}$, C, and K_r are obtained from the initial PDCCH or EPDCCH for the same transport block. If there is no initial PDCCH or EPDCCH with DCI format 0 for the same transport block, $M_{sc}^{PUSCH-initial}$, C, and K_r shall be determined from: the most recent semi-persistent scheduling assignment PDCCH or EPDCCH, when the initial PUSCH for the same transport block is semi-persistently scheduled, or, the random access response grant for the same transport block, when the PUSCH is initiated by the random access response grant.

[0210] In an example implementation, for the case when two transport blocks are transmitted in the PUSCH conveying the HARQ-ACK bits, rank indicator bits or CRI bits:

$$Q' = \max[\min(Q'_{temp}, 4 \cdot M_{sc}^{PUSCH}), Q'_{min}] \text{ with}$$

$$Q'_{temp} = \left\lceil \frac{O \cdot M_{sc}^{PUSCH-initial(1)} \cdot N_{symb}^{PUSCH-initial(1)} + M_{sc}^{PUSCH-initial(2)} \cdot N_{symb}^{PUSCH-initial(2)} \cdot \beta_{offset}^{PUSCH}}{\sum_{r=0}^{C^{(1)}-1} K_r^{(1)} \cdot M_{sc}^{PUSCH-initial(2)} \cdot N_{symb}^{PUSCH-initial(2)} + \sum_{r=0}^{C^{(2)}-1} K_r^{(2)} \cdot M_{sc}^{PUSCH-initial(1)} \cdot N_{symb}^{PUSCH-initial(1)}} \right\rceil$$

[0211] where O is the number of HARQ-ACK bits, rank indicator bits or CRI bits, and $Q'_{min} = 0$ if $O \leq 2$, $Q'_{min} = \lceil 2O / Q_m \rceil$ if $3 \leq O \leq 11$ with $Q_m = \min(Q_m^1, Q_m^2)$ where $Q_m^x, x=\{1, 2\}$

2} is the modulation order of transport block “x”, and $Q_{min} = \lceil 2O_1/Q_m \rceil + \lceil 2O_2/Q_m \rceil$ if $O > 11$ with $O_1 = \lfloor O/2 \rfloor$ and $O_2 = O - \lfloor O/2 \rfloor$. $M_{sc}^{PUSCH-initial(x)}$, $x = \{1, 2\}$ are the scheduled bandwidths for PUSCH transmission in the initial sub-frame for the first and second transport block, respectively, expressed as a number of subcarriers in [2], and $N_{symb}^{PUSCH-initial(x)}$, $x = \{1, 2\}$ are the number of SC-FDMA symbols per subframe for initial PUSCH transmission for the first and second transport block given by $N_{symb}^{PUSCH-initial(x)} = (2 \cdot (N_{symb}^{UL} - 1) - N_{SRS}^{(x)})$, $x = \{1, 2\}$, where $N_{SRS}^{(x)}$, $x = \{1, 2\}$ is equal to 1. If UE configured with one UL cell is configured to send PUSCH and SRS in the same subframe for initial transmission, or if UE transmits PUSCH and SRS in the same subframe in the same serving cell for initial transmission of transport block “x”, or if the PUSCH resource allocation for initial transmission of transport block “x” even partially overlaps with the cell-specific SRS subframe and bandwidth configuration, or if the subframe for initial transmission of transport block “x” in the same serving cell is a UE-specific type-1 SRS subframe, or if the subframe for initial transmission of transport block “x” in the same serving cell is a UE-specific type-0 SRS subframe and the UE is configured with multiple TAGs. Otherwise $N_{SRS}^{(x)}$, $x = \{1, 2\}$ is equal to 0.

[0212] $M_{sc}^{PUSCH-initial(x)}$, $x = \{1, 2\}$, $C^{(x)}$, $x = \{1, 2\}$, and $K_r^{(x)}$, $x = \{1, 2\}$ are obtained from the initial PDCCH or EPDCCH for the corresponding transport block.

[0213] In an example implementation, when the UE transmits channel quality control information bits, it shall determine the number of modulation coded symbols per layer Q' for channel quality information as

$$Q' = \min \left(\left\lceil \frac{(O+L) \cdot M_{sc}^{PUSCH-initial(x)} \cdot N_{symb}^{PUSCH-initial(x)} \cdot \beta_{offset}^{PUSCH}}{\sum_{r=0}^{C^{(x)}-1} K_r^{(x)}} \right\rceil, \left\lfloor \frac{M_{sc}^{PUSCH} \cdot N_{symb}^{PUSCH} - \frac{Q_{RI}^{(x)}}{Q_m^{(x)}}}{1} \right\rfloor \right)$$

[0214] where O is the number of CQI/PMI bits, and L is the number of CRC bits given by

$$L = \begin{cases} 0 & O \leq 11 \\ 8 & \text{otherwise} \end{cases}$$

and $Q_{CQI} = Q_m^{(x)} \cdot Q'$ and $\beta_{offset}^{PUSCH} = \beta_{offset}^{CQI}$, where β_{offset}^{CQI} may be determined according to [3] depending on the number of transmission codewords for the corresponding PUSCH, and on the uplink power control subframe set for the corresponding PUSCH when two uplink power control subframe sets are configured by higher layers for the cell. If RI or CRI is not transmitted then $Q_{RI}^{(x)} = 0$.

[0215] The variable “x” in $K_r^{(x)}$ represents the transport block index corresponding to the highest IMCS value indicated by the initial UL grant. In case the two transport blocks have the same IMCS value in the corresponding initial UL grant, “x=1”, which corresponds to the first transport block. $M_{sc}^{PUSCH-initial(x)}$, $C^{(x)}$, and $K_r^{(x)}$ are obtained from the initial PDCCH or EPDCCH for the same transport block. If there is no initial PDCCH or EPDCCH with DCI format 0 for the same transport block, $M_{sc}^{PUSCH-initial(x)}$, $C^{(x)}$, and

$K_r^{(x)}$ may be determined from: the most recent semi-persistent scheduling assignment PDCCH or EPDCCH, when the initial PUSCH for the same transport block is semi-persistently scheduled, or, the random access response grant for the same transport block, when the PUSCH is initiated by the random access response grant.

[0216] $N_{symb}^{PUSCH-initial(x)}$ is the number of SC-FDMA symbols per subframe for initial PUSCH transmission for the same transport block. In an example implementation, for UL-SCH data information $G = N_L^{(x)} \cdot (N_{symb}^{PUSCH} \cdot M_{sc}^{PUSCH} \cdot Q_m^{(x)} - Q_{CQI} - Q_{RI}^{(x)})$, where $N_L^{(x)}$ is the number of layers the corresponding UL-SCH transport block is mapped onto, and M_{sc}^{PUSCH} is the scheduled bandwidth for PUSCH transmission in the current sub-frame for the transport block, and N_{symb}^{PUSCH} is the number of SC-FDMA symbols in the current PUSCH transmission sub-frame given by $N_{symb}^{PUSCH} = (2 \cdot (N_{symb}^{UL} - 1) - N_{SRS})$, where N_{SRS} is equal to 1, if UE configured with one UL cell is configured to send PUSCH and SRS in the same subframe for initial transmission, or if UE transmits PUSCH and SRS in the same subframe for the current subframe in the same serving cell, or if the PUSCH resource allocation for the current subframe even partially overlaps with the cell-specific SRS subframe and bandwidth configuration, or if the current subframe in the same serving cell is a UE-specific type-1 SRS subframe, or if the current subframe in the same serving cell is a UE-specific type-0 SRS subframe as defined and the UE is configured with multiple TAGs. Otherwise N_{SRS} is equal to 0.

[0217] The above examples describe some example PUSCH and/or SRS transmission mechanisms according to Release 13 of LTE standards. 3GPP 36 series of RAN standards describes details of LTE-Advanced Release 13 uplink transmission processes. The above release 13 uplink transmissions include much inefficiency in transmission of PUSCH and/or SRS. Example embodiments of the invention enhance transmission of PUSCH and/or SRS in the uplink.

[0218] The example embodiments of the invention may improve uplink transmission spectral efficiency in some scenarios. In an example embodiment, uplink SCH and/or SRS transmission mechanisms are enhanced to increase uplink transmission throughput and/or spectral efficiency.

[0219] In Release 13, PUSCH is not mapped to resource elements (k,l) corresponding to the physical resource blocks assigned for transmission that is part of: a) the last SC-FDMA symbol in a subframe, if the UE transmits SRS in the same subframe in the same serving cell, or b) the last SC-FDMA symbol in a subframe configured with cell-specific SRS, if the PUSCH transmission partly or fully overlaps with the cell-specific SRS bandwidth, or c) an SC-FDMA symbol reserved for possible SRS transmission in a UE-specific aperiodic SRS subframe in the same serving cell, or d) an SC-FDMA symbol reserved for possible SRS transmission in a UE-specific periodic SRS subframe in the same serving cell when the UE is configured with multiple TAGs.

[0220] These resource mapping limitations may reduce available REs for UL-SCH. This resource mapping limitations may create discontinuous transmission in the uplink. Discontinuous transmission in the uplink may reduce uplink transmission efficiency. In an example, discontinuous transmission in the uplink may reduce uplink transmission efficiency in an LAA cell. For example, a UE may transmit a resource block and map it to REs excluding the last symbol

of subframe n . For example, subframe n may be part of the last SC-FDMA symbol in a subframe configured with cell-specific SRS, and the PUSCH transmission partly or fully overlaps with the cell-specific SRS bandwidth. The same UE may have a grant for subframe $n+1$. Another node, may occupy the channel at right before subframe $n+1$, when the UE stops its transmission during the last symbol of subframe n . The same UE may not be able to transmit at subframe $n+1$ anymore. It is advantageous to implement a mechanism that increases the possibility of continuous transmission in the uplink of an LAA cell. SRS configuration may be periodic. An uplink data transmission burst may start at any subframe depending on the transmission scenario. Example embodiments of the invention may increase the possibility of longer continuous transmission by a UE. This may improve uplink transmission efficiency, battery power consumption, and/or throughput.

[0221] Example embodiments improve the duration of a transmission burst. An UL transmission burst from a UE perspective may be a continuous transmission from a UE with no transmission immediately before or after from the same UE on the same CC. Increasing the duration of UL transmission burst may improve uplink transmission in an LAA cell. Before a transmission, a UE may need to perform LBT process and/or may transmit a reservation signal. Both of these actions consume battery power consumption. Increased transmission of a reservation signal may unnecessarily reduce uplink resource efficiency. Example embodiments may improve the uplink transmission burst duration and enhance PUSCH and/or SRS transmission process.

[0222] For example, in Release 13, PUSCH is not mapped to resource elements (k,l) corresponding to the physical resource blocks assigned for transmission that is part of the last SC-FDMA symbol in a subframe configured with cell-specific SRS, if the PUSCH transmission partly or fully overlaps with the cell-specific SRS bandwidth. Such constraints may reduce UL transmission burst duration. FIG. 16 shows an example. In FIG. 16, PUSCH resources overlaps with cell-specific SRS resource, and the UE may not transmit PUSCH TB in the last SC-FDMA symbol. For example, if a UE UL transmission burst started in this subframe, it had to end in the same subframe, unless the same UE transmits an SRS as well in the last symbol.

[0223] In an example scenario, in FIG. 16, UL transmission burst may end in the subframe, even if no other UE transmits an SRS in the cell-specific SRS resources in the subframe. In an example scenario, in FIG. 16, UL transmission burst may end in the subframe, even if another UE transmits just an SRS (without a PUSCH in the same subframe) in the cell-specific SRS resources in the subframe. An enhanced SRS transmission mechanism implemented in the example embodiment, improves SRS and UE transmission processes.

[0224] In an example embodiment, PUSCH of UE may be mapped to resource elements (k,l) corresponding to the physical resource blocks assigned for transmission that is part of the last SC-FDMA symbol in a subframe configured with cell-specific SRS, even if the PUSCH transmission partly or fully overlaps with the cell-specific SRS bandwidth. This may enable the UE to continue its UL transmission burst into the next subframe. Such feature may provide many advantages in an LAA cell.

[0225] In an example embodiment, cell-specific SRS resources may comprise srs-BandwidthConfig: ENUMERATED

{bw0, bw1, bw2, bw3, bw4, bw5, bw6, bw7}, srs-SubframeConfig: ENUMERATED {sc0, sc1, sc2, sc3, sc4, sc5, sc6, sc7, sc8, sc9, sc10, sc11, sc12, sc13, sc14, sc15}, ackNackSRS-SimultaneousTransmission: BOOLEAN, srs-MaxUpPts: ENUMERATED {true} OPTIONAL—Cond TDD.

[0226] In the example embodiment, resources identified by srs-BandwidthConfig (Parameter: SRS Bandwidth Configuration) and srs-SubframeConfig (Parameter: SRS Subframe Configuration.) may not be reserved for SRS in every subframe configured for cell-specific SRS. Blanking out the last symbol in a PUSCH transmission may reduce UL continuous transmission time.

[0227] In an example embodiment, no cell specific SRS may be configured for an LAA cell. UE specific SRS resources may be configured without configuring cell specific SRS resources. In LTE-release 13 or before, cell specific SRS resources must be configured in order to configure UE specific SRS configuration. In an example embodiment, not configuring cell-specific SRS may provide flexibility in eNB to configure and/or trigger SRS transmission in a subframe independent of whether cell-specific SRS resources are configured for the subframe. An eNB may transmit to a UE an uplink DCI comprising an SRS request field indicating whether SRS transmission is triggered in a subframe. A UE may transmit an SRS in the subframe, when the UE is triggered to transmit the SRS in the subframe. The trigger may be based on RRC configuration and PDCCH DCI comprising the trigger information. The UE may transmit the SRS according to RRC configuration parameters.

[0228] For example, an eNB may transmit via a (e)PDCCH an uplink DCI grant comprising a one-bit field indicating that the UE may employ the last SC-FDMA symbol in a subframe for PUSCH transmission. The DCI may indicate whether the UE should transmit PUSCH in the last symbol of a subframe. This may happen for example for the last subframe of an UL burst so that an uplink burst may be terminated before the last symbol of the last subframe of the UL burst (last symbol of the last subframe may be left blank) (FIG. 17). The DCI may be transmitted in the UE specific search space and may be associated with the C-RNTI associated with the UE. For example, the DCI may be encoded and/or scrambled using the UE RNTI. In an example embodiment, the DCI may be monitored, and may be transmitted in subframe n , to provide information for subframe $n+x$ (e.g. $x=2, 4, 5, 6$).

[0229] In an example embodiment, a dedicated uplink DCI may inform the UE whether the UE may transmit PUSCH in the last symbol of a subframe. When the last symbol indicates transmission in the last symbol, the UE may transmit PUSCH in the last symbol. When the last symbol indicates that PUSCH is not transmitted in the last symbol, the UE may not transmit PUSCH in the last symbol. The last symbol of the subframe may interfere with the SRS in the subframe (FIG. 16). In an example embodiment, the eNB may use the dedicated DCI to inform whether the UE should transmit PUSCH in the last symbol even if the last symbol does not overlap with the SRS transmission. For example, the last symbol may be the last symbol of an uplink transmission burst. The eNB may instruct the UE not to transmit PUSCH in the last symbol of the last subframe to allow other UEs to perform LBT for uplink transmission (FIG. 17). In an example, the last symbol may be employed for SRS transmission. In an example, no signal may be transmitted in the last symbol of the subframe, and the last symbol may be blanked out. This may allow other UEs scheduled in the next subframe to perform LBT for transmission in the next subframe. For example, the DCI may be applicable to the last subframe of an uplink burst.

[0230] In an example embodiment, an eNB may transmit to a UE a dedicated uplink DCI grant for a burst comprising one or more subframes. The dedicated uplink DCI may indicate to the UE whether the UE may transmit PUSCH in the last symbol of an uplink burst. The indication may be for the last symbol of one or more subframes. In an example embodiment, the eNB may use the dedicated uplink DCI to inform whether the UE should transmit PUSCH in the last symbol of an uplink burst. The eNB may instruct the UE not to transmit PUSCH in the last symbol of the last subframe. In an example, the DCI may include a bit indicating whether the last symbol of an uplink transmission burst is employed for PUSCH transmission. In an example, the last subframe of a burst may be considered an ending subframe, wherein the last symbol of the subframe is left blank. In an example, this may enable other UEs to transmit SRS in the last symbol.

[0231] The example embodiments of the invention may be employed in an eNB and a UE to enhance uplink transmission in a UE. For example, it may enable longer uplink transmission burst. The example embodiments may increase uplink transmission efficiency.

[0232] Uplink power control may control the transmit power of the different uplink physical channels. For PUSCH, the transmit power $\hat{P}_{PUSCH,c}(i)$, may be first scaled by the ratio of the number of antennas ports with a non-zero PUSCH transmission to the number of configured antenna ports for the transmission scheme. The resulting scaled power may be split equally across the antenna ports on which the non-zero PUSCH is transmitted.

[0233] For PUCCH or SRS, the transmit power $\hat{P}_{PUCCH}(i)$, or $\hat{P}_{SRS,c}(i)$ may be split equally across the configured antenna ports for PUCCH or SRS. $\hat{P}_{SRS,c}(i)$ is the linear value of $P_{SRS,c}(i)$ For a serving cell with frame structure type 1, a UE may not be expected to be configured with UplinkPowerControlDedicated-v12x0.

[0234] In an example, the setting of the UE Transmit power for a Physical Uplink Shared Channel (PUSCH) transmission may be defined as follows. If the UE transmits PUSCH without a simultaneous PUCCH for the serving cell c, then the UE transmit power $P_{PUSCH,c}(i)$ for PUSCH transmission in subframe i for the serving cell c may be given by

$$P_{PUSCH,c}(i) = \min \left\{ \begin{array}{l} P_{CMAX,c}(i), \\ 10 \log_{10}(M_{PUSCH,c}(i) + P_{O,PUSCH,c}(j) + \alpha_c(j) \cdot PL_c + \Delta_{TF,c}(i) + f_c(i)) \end{array} \right\} \quad [dBm]$$

[0235] In an example, if the UE transmits PUSCH simultaneous with PUCCH for the serving cell C, then the UE transmit power $P_{PUSCH,c}(i)$ for the PUSCH transmission in subframe i for the serving cell c is given by

$$P_{PUSCH,c}(i) = \min \left\{ \begin{array}{l} 10 \log_{10}(\hat{P}_{CMAX,c}(i) - \hat{P}_{PUCCH}(i)), \\ 10 \log_{10}(M_{PUSCH,c}(i) + P_{O,PUSCH,c}(j) + \alpha_c(j) \cdot PL_c + \Delta_{TF,c}(i) + f_c(i)) \end{array} \right\} \quad [dBm]$$

[0236] In an example, if the UE is not transmitting PUSCH for the serving cell c, for the accumulation of TPC command received with DCI format 3/3A for PUSCH, the UE may assume that the UE transmit power $P_{PUSCH,c}(i)$ for

the PUSCH transmission in subframe i for the serving cell c is computed by $P_{PUSCH,c}(i) = \min\{P_{CMAX,c}(i), P_{O,PUSCH,c}(i) + \alpha_c(i) \cdot PL_c + f_c(i)\}$ [dBm].

[0237] where, $P_{CMAX,c}(i)$ may be the configured UE transmit power in subframe i for serving cell c and $\hat{P}_{CMAX,c}(i)$ is the linear value of $P_{CMAX,c}(i)$. If the UE does not transmit PUCCH and PUSCH in subframe i for the serving cell c, for the accumulation of TPC command received with DCI format 3/3A for PUSCH, the UE may compute $P_{CMAX,c}(i)$ assuming MPR=0 dB, A-MPR=0 dB, P-MPR=0 dB and $\square TC=0$ dB, where MPR, A-MPR, P-MPR and $\square TC$. $\hat{P}_{PUCCH}(i)$ may be the linear value of $P_{PUCCH}(i)$. $M_{PUSCH,c}(i)$ may be the bandwidth of the PUSCH resource assignment expressed in number of resource blocks valid for subframe i and serving cell c. Parameters in the power control mechanism may be described in latest release of 3GPP TS 36.213 specifications. PL_c may be the downlink path loss estimate calculated in the UE for serving cell c in dB and $PL_c = \text{referenceSignalPower} - \text{higher layer filtered RSRP}$, where referenceSignalPower is provided by higher layers for the reference serving cell and the higher layer filter configuration for the reference serving cell.

[0238] In an example, $\delta_{PUSCH,c}$ may be a correction value, also referred to as a TPC command and is included in PDCCH/EPDCCH with DCI format 0/4 for serving cell c or jointly coded with other TPC commands in PDCCH with DCI format 3/3A whose CRC parity bits are scrambled with TPC-PUSCH-RNTI. If the UE is configured with higher layer parameter UplinkPowerControlDedicated-v12x0 for serving cell c and if subframe i belongs to uplink power control subframe set 2 as indicated by the higher layer parameter tpc-SubframeSet-r12, the current PUSCH power control adjustment state for serving cell c is given by $f_{c,2}(i)$, and the UE may use $f_{c,2}(i)$ instead of $f_c(i)$ to determine $P_{PUSCH,c}(i)$. Otherwise, the current PUSCH power control adjustment state for serving cell c is given by $f_c(i)$. $f_{c,2}(i)$ and $f_c(i)$ are defined by: $f_c(i) = f_c(i-1) + \delta_{PUSCH,c}(i - K_{PUSCH})$ and $f_{c,2}(i) = f_{c,2}(i-1) + \delta_{PUSCH,c}(i - K_{PUSCH})$ if accumulation is enabled based on the parameter Accumulation-enabled provided by higher layers or if the TPC command $\delta_{PUSCH,c}$ is included in a PDCCH/EPDCCH with DCI format 0 for serving cell c where the CRC is scrambled by the Temporary C-RNTI. The value of K_{PUSCH} may be predefined. $f_c(i) = \delta_{PUSCH,c}(i - K_{PUSCH})$ and $f_{c,2}(i) = \delta_{PUSCH,c}(i - K_{PUSCH})$ if accumulation is not enabled for serving cell c based on the parameter Accumulation-enabled provided by higher layers.

[0239] In an example, if the UE is not configured with an SCG or a PUCCH-SCell, and if the total transmit power of the UE would exceed $\hat{P}_{CMAX}(i)$, the UE may scale $\hat{P}_{PUSCH,c}(i)$ for the serving cell c in subframe i such that the condition

$$\sum_c w(i) \cdot \hat{P}_{PUSCH,c}(i) \leq (\hat{P}_{CMAX}(i) - \hat{P}_{PUCCH}(i))$$

is satisfied where $\hat{P}_{PUCCH}(i)$ is the linear value of $P_{PUCCH}(i)$, $\hat{P}_{PUSCH,c}(i)$ is the linear value of $P_{PUSCH,c}(i)$, $\hat{P}_{CMAX}(i)$ is the linear value of the UE total configured maximum output power P_{CMAX} in subframe i and $w(i)$ is a scaling factor of $P_{PUSCH,c}(i)$ for serving cell C where $0 \leq w(i) \leq 1$. In case there is no PUCCH transmission in subframe i $\hat{P}_{PUCCH}(i) = 0$.

[0240] In an example, if the UE is not configured with an SCG or a PUCCH-SCell, and if the UE has PUSCH transmission with UCI on serving cell j and PUSCH without UCI in any of the remaining serving cells, and the total transmit

power of the UE would exceed $\hat{P}_{CMAX}(i)$, the UE scales $\hat{P}_{PUSCH,c}(i)$ for the serving cells without UCI in subframe i such that the condition

$$\sum_{c \neq j} w(i) \cdot \hat{P}_{PUSCH,c}(i) \leq (\hat{P}_{CMAX}(i) - \hat{P}_{PUCCH}(i))$$

is satisfied where $\hat{P}_{PUSCH,j}(i)$ is the PUSCH transmit power for the cell with UCI and $w(i)$ is a scaling factor of $\hat{P}_{PUSCH,c}(i)$ for serving cell c without UCI. In this case, no power scaling may be applied to $\hat{P}_{PUSCH,j}(i)$ (unless

$$\sum_{c \neq j} w(i) \cdot \hat{P}_{PUSCH,c}(i) = 0$$

and the total transmit power of the UE still would exceed $\hat{P}_{CMAX}(i)$.

[0241] For a UE not configured with a SCG or a PUCCH-SCell, $w(i)$ values may be the same across serving cells when $w(i) > 0$ but for certain serving cells $w(i)$ may be zero.

[0242] In an example, if the UE is not configured with an SCG or a PUCCH-SCell, and if the UE has simultaneous PUCCH and PUSCH transmission with UCI on serving cell j and PUSCH transmission without UCI in any of the remaining serving cells, and the total transmit power of the UE would exceed $\hat{P}_{CMAX}(i)$, the UE obtains $\hat{P}_{PUSCH,c}(i)$ according to

$$\hat{P}_{PUSCH,j}(i) = \min(\hat{P}_{PUSCH,j}(i), (\hat{P}_{CMAX}(i) - \hat{P}_{PUCCH}(i)))$$

and

$$\sum_{c \neq j} w(i) \cdot \hat{P}_{PUSCH,c}(i) \leq (\hat{P}_{CMAX}(i) - \hat{P}_{PUCCH}(i) - \hat{P}_{PUSCH,j}(i)).$$

[0243] In an example, if serving cell c is the primary cell, for PUCCH format 1/1a/1b/2/2a/2b/3, the setting of the UE Transmit power P_{PUCCH} for the physical uplink control channel (PUCCH) transmission in subframe i for serving cell c may be defined by

$$P_{PUCCH}(i) = \min$$

$$\left\{ \begin{array}{l} P_{CMAX,c}(i), \\ P_{0_PUCCH} + PL_c + h \left(\begin{array}{l} n_{CQI}, n_{HARQ} \\ n_{SR} \end{array} \right) + \Delta_{F_PUCCH}(F) + \Delta_{TxD}(F') + g(i) \end{array} \right\}$$

[dBm]

[0244] In an example, if serving cell c is the primary cell, for PUCCH format 4/5, the setting of the UE Transmit power P_{PUCCH} for the physical uplink control channel (PUCCH) transmission in subframe i for serving cell C is defined by

$$P_{PUCCH}(i) = \min \left\{ \begin{array}{l} P_{CMAX,c}(i), \\ P_{0_PUCCH} + PL_c + 10 \log_{10}(M_{PUCCH,c}(i)) + \\ \Delta_{TF,c}(i) + \Delta_{F_PUCCH}(F) + g(i) \end{array} \right\}$$

[dBm]

[0245] If the UE is not transmitting PUCCH for the primary cell, for the accumulation of TPC command for PUCCH, the UE may assume that the UE transmit power P_{PUCCH} for PUCCH in subframe i is computed by

$$P_{PUCCH}(i) = \min\{P_{CMAX,c}(i), P_{0_PUCCH} + PL_c + g(i)\}$$

[dBm]

[0246] In an example, the setting of the UE Transmit power P_{SRS} for the SRS transmitted on subframe i for serving cell c may be defined by

$$P_{SRS,c}(i) = \min\{P_{CMAX,c}(i), P_{SRS_OFFSET,c}(m) + 10 \log_{10}(M_{SRS,c} + P_{0_PUSCH,c}(j) + \alpha_c(j)) + PL_c + f_c(i)\}$$

[dBm]

[0247] Where $P_{CMAX,c}(i)$ may be the configured UE transmit power in subframe i for serving cell c . $P_{SRS_OFFSET,c}(m)$ may be semi-statically configured by higher layers for $m=0$ and $m=1$ for serving cell c . For SRS transmission given trigger type 0 then $m=0$ and for SRS transmission given trigger type 1 then $m=1$. $M_{SRS,c}$ may be the bandwidth of the SRS transmission in subframe i for serving cell c expressed in number of resource blocks. $f_c(i)$ may be the current PUSCH power control adjustment state for serving cell. $P_{0_PUSCH,c}(i)$ and $\alpha_c(j)$ may be parameters as for subframe i , where $j=1$.

[0248] In an example, if the UE is not configured with an SCG or a PUCCH-SCell, and if the total transmit power of the UE for the Sounding Reference Symbol in an SC-FDMA symbol would exceed $\hat{P}_{CMAX}(i)$, the UE may scale $\hat{P}_{SRS,c}(i)$ for the serving cell c and the SC-FDMA symbol in subframe i such that the condition

$$\sum_c w(i) \cdot \hat{P}_{SRS,c}(i) \leq \hat{P}_{CMAX}(i)$$

is satisfied where $\hat{P}_{SRS,c}(i)$ is the linear value of $P_{SRS,c}(i)$, $P_{CMAX}(i)$ is the linear value of P_{CMAX} in subframe i and $w(i)$ is a scaling factor of $\hat{P}_{SRS,c}$ for serving cell c where $0 < w(i) \leq 1$. In an example, in an enhanced SRS procedures some of the SRS signals may be prioritized over some other SRS signals. In an example, some of the SRS signals may be dropped or scaled according to an SRS priority mechanism in example embodiments.

[0249] In an example, if the UE is not configured with an SCG or a PUCCH-SCell, and if the UE is configured with multiple TAGs and the SRS transmission of the UE in an SC-FDMA symbol for a serving cell in subframe i in a TAG overlaps with the SRS transmission in another SC-FDMA symbol in subframe i for a serving cell in another TAG, and if the total transmit power of the UE for the Sounding Reference Symbol in the overlapped portion would exceed $\hat{P}_{CMAX}(i)$, the UE scales $\hat{P}_{SRS,c}(i)$ for the serving cell c and a of the overlapped SRS SC-FDMA symbols in subframe i such that the condition

$$\sum_c w(i) \cdot \hat{P}_{SRS,c}(i) \leq \hat{P}_{CMAX}(i)$$

is satisfied where $\hat{P}_{SRS,c}(i)$ is the linear value of $P_{SRS,c}(i)$, $\hat{P}_{CMAX}(i)$ is the linear value of P_{CMAX} in subframe i and $w(i)$ is a scaling factor of $\hat{P}_{SRS,c}(i)$ for serving cell c where $0 < w(i) \leq 1$. In an example, in an enhanced SRS procedures some of the SRS signals may be prioritized over some other SRS signals. In an example, some of the SRS signals may be dropped or scaled according to an SRS priority mechanism in example embodiments.

[0250] In an example, if the UE is configured with higher layer parameter UplinkPowerControlDedicated-v12x0 for serving cell c and if subframe i belongs to uplink power control subframe set 2 as indicated by the higher layer parameter tpc-SubframeSet-r12, the UE may use $f_{c,2}(i)$ instead of $f_c(i)$ to determine $P_{SRS,c}(i)$ for subframe i and serving cell c .

[0251] In an example, a UE may transmit Sounding Reference Symbol (SRS) on per serving cell SRS resources based on two trigger types: trigger type 0: e.g. higher layer signalling and/or trigger type 1: e.g. DCI formats 0/4/1A for FDD and TDD and DCI formats 2B/2C/2D for TDD. In case both trigger type 0 and trigger type 1 SRS transmissions would occur in the same subframe in the same serving cell, the UE may only transmit the trigger type 1 SRS transmission.

[0252] A UE may be configured with SRS parameters for trigger type 0 and trigger type 1 on a serving cell. One or more of the following SRS parameters may be serving cell specific and semi-statically configurable by higher layers for trigger type 0 and for trigger type 1: Number of combs K_{TC} for trigger type 0 and a configuration of trigger type 1, if configured; Transmission comb \bar{K}_{TC} , for trigger type 0 and a configuration of trigger type 1; Starting physical resource block assignment n_{RRC} , for trigger type 0 and a configuration of trigger type 1; duration: single or indefinite (until disabled), for trigger type 0; srs-ConfigIndex ISRS for SRS periodicity T_{SRS} and SRS subframe offset T_{offset} , for trigger type 0 and SRS periodicity $T_{SRS,1}$ and SRS subframe offset $T_{offset,1}$, for trigger type 1; SRS bandwidth B_{SRS} , for trigger type 0 and a configuration of trigger type 1; Frequency hopping bandwidth, b_{hop} , for trigger type 0; Cyclic shift n_{SRS}^{cs} , for trigger type 0 and a configuration of trigger type 1; and Number of antenna ports N_p for trigger type 0 and a configuration of trigger type 1.

[0253] According to various embodiments, a device such as, for example, a wireless device, a base station and/or the like, may comprise one or more processors and memory. The memory may store instructions that, when executed by the one or more processors, cause the device to perform a series of actions. Embodiments of example actions are illustrated in the accompanying figures and specification.

[0254] FIG. 18 is an example flow diagram as per an aspect of an embodiment of the present disclosure. At **1810**, a wireless device may receive one or more messages. The at least one message may comprise configuration parameters for a licensed assisted access (LAA) cell. The configuration parameters may comprise one or more sounding reference signal (SRS) parameters. A downlink control information (DCI) may be received at **1820**. The DCI may comprise: a resource block assignment field for a subframe, an SRS request field indicating whether an SRS is transmitted in the last symbol of the subframe, and an ending symbol field for a physical uplink shared channel (PUSCH) indicating whether the PUSCH is transmitted in a last symbol of the subframe. The wireless device may transmit at **1830**, in the

subframe and via the PUSCH, one or more transport blocks based on the ending symbol field. At **1840**, the wireless device may transmit the SRS signal in the last symbol of the subframe when the SRS request field indicates that SRS transmission is triggered. No cell-specific SRS subframe may be configured for the LAA cell.

[0255] The ending symbol field may be, for example, one bit. The SRS configuration parameters may comprise, for example, an SRS bandwidth parameter. According to an embodiment, the wireless device may transmit the SRS in parallel with the one or more transport blocks when: the ending symbol field indicates that the PUSCH is transmitted in the last symbol, and the SRS field indicates the SRS is transmitted in the subframe. According to an embodiment, the wireless device may perform a listen before talk procedure indicating that a channel is clear before transmitting in the subframe. The DCI may be, for example, associated with a cell radio network temporary identifier (C-RNTI) of the wireless device.

[0256] FIG. 19 is an example flow diagram as per an aspect of an embodiment of the present disclosure. At **1910**, a wireless device may receive one or more radio resource control (RRC) messages. The one or more RRC messages may comprise configuration parameters for a licensed assisted access (LAA) cell. A downlink control information (DCI) may be received at **1920**. The DCI may indicate uplink resources for an uplink burst. The uplink burst may comprise a number of a plurality of consecutive uplink subframes of the LAA cell. The DCI may comprise: the number of the plurality of consecutive uplink subframes in the uplink burst, an assignment of a plurality of resource blocks, and an ending symbol field for a physical uplink shared channel (PUSCH) indicating whether the PUSCH is transmitted in a last symbol of the uplink burst. A listen before talk procedure may be performed at **1930** indicating that a channel is clear for a starting subframe of the uplink burst. At **1940**, the device may transmit, via the plurality of resource blocks used across the plurality of consecutive uplink subframes, one or more transport blocks in the PUSCH according to the ending symbol field.

[0257] The ending symbol field may comprise, for example, one bit. The DCI may further comprise, for example, at least one of: a modulation and coding scheme, a hybrid automatic repeat request (HARQ) identifier, a redundancy version (RV), a transmit power control (TPC) command, or a new data indicator (NDI).

[0258] The listen before talk procedure may indicate, for example, that the channel is clear when a detected channel energy is below a threshold. The one or more parameters of the listen before talk procedure may depend, for example, on a priority class of at least one of the one or more transport blocks. The device may further transmit a sounding reference signal (SRS) in a subframe of the plurality of consecutive uplink subframes. The one or more RRC messages may comprise, for example, one or more consecutive uplink subframe allocation configuration parameters comprising a first field. The first field may indicate, for example, an upper limit for the number of the plurality of consecutive uplink subframes.

[0259] FIG. 20 is an example flow diagram as per an aspect of an embodiment of the present disclosure. At **2010**, a base station may transmit one or more radio resource control (RRC) messages. The one or more RRC messages may comprise configuration parameters for a licensed

assisted access (LAA) cell. A downlink control information (DCI) may be transmitted by the base station to the wireless device at **2020**. The DCI may indicate uplink resources for an uplink burst. The uplink burst may comprise a number of a plurality of consecutive uplink subframes of the LAA cell. The DCI may comprise: the number of the plurality of consecutive uplink subframes in the uplink burst, an assignment of a plurality of resource blocks, and an ending symbol field for a physical uplink shared channel (PUSCH) indicating whether the PUSCH is transmitted in a last symbol of the uplink burst. A listen before talk procedure may be performed by the wireless device indicating that a channel is clear for a starting subframe of the uplink burst. At **2040**, the base station may transmit, via the plurality of resource blocks used across the plurality of consecutive uplink subframes, one or more transport blocks in the PUSCH according to the ending symbol field.

[0260] FIG. 21 is an example flow diagram as per an aspect of an embodiment of the present disclosure. At **2110**, a base station may transmit one or more messages. The at least one message may comprise configuration parameters for a licensed assisted access (LAA) cell. The configuration parameters may comprise one or more sounding reference signal (SRS) parameters. The base station may transmit a downlink control information (DCI) at **2120**. The DCI may comprise: a resource block assignment field for a subframe, an SRS request field indicating whether an SRS is transmitted in the last symbol of the subframe, and an ending symbol field for a physical uplink shared channel (PUSCH) indicating whether the PUSCH is transmitted in a last symbol of the subframe. The base station may receive at **2130**, in the subframe and via the PUSCH, one or more transport blocks based on the ending symbol field. At **2140**, the base station may receive the SRS signal in the last symbol of the subframe when the SRS request field indicates that SRS transmission is triggered. No cell-specific SRS subframe may be configured for the LAA cell.

[0261] In this specification, “a” and “an” and similar phrases are to be interpreted as “at least one” and “one or more.” In this specification, the term “may” is to be interpreted as “may, for example.” In other words, the term “may” is indicative that the phrase following the term “may” is an example of one of a multitude of suitable possibilities that may, or may not, be employed to one or more of the various embodiments. If A and B are sets and every element of A is also an element of B, A is called a subset of B. In this specification, only non-empty sets and subsets are considered. For example, possible subsets of $B = \{\text{cell1}, \text{cell2}\}$ are: $\{\text{cell1}\}$, $\{\text{cell2}\}$, and $\{\text{cell1}, \text{cell2}\}$.

[0262] In this specification, parameters (Information elements: IEs) may comprise one or more objects, and each of those objects may comprise one or more other objects. For example, if parameter (IE) N comprises parameter (IE) M, and parameter (IE) M comprises parameter (IE) K, and parameter (IE) K comprises parameter (information element) J, then, for example, N comprises K, and N comprises J. In an example embodiment, when one or more messages comprise a plurality of parameters, it implies that a parameter in the plurality of parameters is in at least one of the one or more messages, but does not have to be in each of the one or more messages.

[0263] Many of the elements described in the disclosed embodiments may be implemented as modules. A module is defined here as an isolatable element that performs a defined

function and has a defined interface to other elements. The modules described in this disclosure may be implemented in hardware, software in combination with hardware, firmware, wetware (i.e hardware with a biological element) or a combination thereof, all of which are behaviorally equivalent. For example, modules may be implemented as a software routine written in a computer language configured to be executed by a hardware machine (such as C, C++, Fortran, Java, Basic, Matlab or the like) or a modeling/simulation program such as Simulink, Stateflow, GNU Octave, or LabVIEWMathScript. Additionally, it may be possible to implement modules using physical hardware that incorporates discrete or programmable analog, digital and/or quantum hardware. Examples of programmable hardware comprise: computers, microcontrollers, microprocessors, application-specific integrated circuits (ASICs); field programmable gate arrays (FPGAs); and complex programmable logic devices (CPLDs). Computers, microcontrollers and microprocessors are programmed using languages such as assembly, C, C++ or the like. FPGAs, ASICs and CPLDs are often programmed using hardware description languages (HDL) such as VHSIC hardware description language (VHDL) or Verilog that configure connections between internal hardware modules with lesser functionality on a programmable device. Finally, it needs to be emphasized that the above mentioned technologies are often used in combination to achieve the result of a functional module.

[0264] The disclosure of this patent document incorporates material which is subject to copyright protection. The copyright owner has no objection to the facsimile reproduction by anyone of the patent document or the patent disclosure, as it appears in the Patent and Trademark Office patent file or records, for the limited purposes required by law, but otherwise reserves all copyright rights whatsoever.

[0265] While various embodiments have been described above, it should be understood that they have been presented by way of example, and not limitation. It will be apparent to persons skilled in the relevant art(s) that various changes in form and detail can be made therein without departing from the spirit and scope. In fact, after reading the above description, it will be apparent to one skilled in the relevant art(s) how to implement alternative embodiments. Thus, the present embodiments should not be limited by any of the above described exemplary embodiments. In particular, it should be noted that, for example purposes, the above explanation has focused on the example(s) using FDD communication systems. However, one skilled in the art will recognize that embodiments of the disclosure may also be implemented in a system comprising one or more TDD cells (e.g. frame structure 2 and/or frame structure 3-licensed assisted access). The disclosed methods and systems may be implemented in wireless or wireline systems. The features of various embodiments presented in this disclosure may be combined. One or many features (method or system) of one embodiment may be implemented in other embodiments. Only a limited number of example combinations are shown to indicate to one skilled in the art the possibility of features that may be combined in various embodiments to create enhanced transmission and reception systems and methods.

[0266] In addition, it should be understood that any figures which highlight the functionality and advantages, are presented for example purposes only. The disclosed architecture is sufficiently flexible and configurable, such that it may be utilized in ways other than that shown. For example, the

actions listed in any flowchart may be re-ordered or only optionally used in some embodiments.

[0267] Further, the purpose of the Abstract of the Disclosure is to enable the U.S. Patent and Trademark Office and the public generally, and especially the scientists, engineers and practitioners in the art who are not familiar with patent or legal terms or phraseology, to determine quickly from a cursory inspection the nature and essence of the technical disclosure of the application. The Abstract of the Disclosure is not intended to be limiting as to the scope in any way.

[0268] Finally, it is the applicant's intent that only claims that include the express language "means for" or "step for" be interpreted under 35 U.S.C. 112. Claims that do not expressly include the phrase "means for" or "step for" are not to be interpreted under 35 U.S.C. 112.

What is claimed is:

1. A method comprising:
 - receiving, at a wireless device, at least one message comprising configuration parameters for a licensed assisted access (LAA) cell, the configuration parameters comprising one or more sounding reference signal (SRS) parameters;
 - receiving a downlink control information (DCI) comprising:
 - a resource block assignment field for a subframe;
 - an SRS request field indicating whether an SRS is transmitted in the last symbol of the subframe; and
 - an ending symbol field for a physical uplink shared channel (PUSCH) indicating whether the PUSCH is transmitted in a last symbol of the subframe;
 - transmitting, in the subframe and via the PUSCH, one or more transport blocks based on the ending symbol field; and
 - transmitting the SRS signal in the last symbol of the subframe when the SRS request field indicates that SRS transmission is triggered; and
 - wherein no cell-specific SRS subframe is configured for the LAA cell.
2. The method of claim 1, wherein the ending symbol field is one bit.
3. The method of claim 1, wherein the SRS configuration parameters comprises an SRS bandwidth parameter.
4. The method of claim 1, wherein the wireless device transmits the SRS in parallel with the one or more transport blocks when:
 - the ending symbol field indicates that the PUSCH is transmitted in the last symbol; and
 - the SRS field indicates the SRS is transmitted in the subframe.
5. The method of claim 1, further comprising performing a listen before talk procedure indicating that a channel is clear before transmitting in the subframe.
6. The method of claim 1, wherein the DCI is associated with a cell radio network temporary identifier (C-RNTI) of the wireless device.
7. A method comprising:
 - receiving one or more radio resource control (RRC) messages comprising configuration parameters for a licensed assisted access (LAA) cell;
 - receiving a downlink control information (DCI) indicating uplink resources for an uplink burst comprising a number of a plurality of consecutive uplink subframes of the LAA cell, the DCI comprising:

- the number of the plurality of consecutive uplink subframes in the uplink burst;
 - an assignment of a plurality of resource blocks; and
 - an ending symbol field for a physical uplink shared channel (PUSCH) indicating whether the PUSCH is transmitted in a last symbol of the uplink burst; and
 - performing a listen before talk procedure indicating that a channel is clear for a starting subframe of the uplink burst; and
 - transmitting, via the plurality of resource blocks used across the plurality of consecutive uplink subframes, one or more transport blocks in the PUSCH according to the ending symbol field.
8. The method of claim 7, wherein the ending symbol field is one bit.
 9. The method of claim 7, wherein the DCI further comprises at least one of:
 - a modulation and coding scheme;
 - a hybrid automatic repeat request (HARQ) identifier;
 - a redundancy version (RV);
 - a transmit power control (TPC) command; or
 - a new data indicator (NDI).
 10. The method of claim 7, wherein the listen before talk procedure indicates that the channel is clear when a detected channel energy is below a threshold.
 11. The method of claim 7, wherein one or more parameters of the listen before talk procedure depend on a priority class of at least one of the one or more transport blocks.
 12. The method of claim 7, further comprising transmitting a sounding reference signal (SRS) in a subframe of the plurality of consecutive uplink subframes.
 13. The method of claim 7, wherein the one or more RRC messages comprise one or more consecutive uplink subframe allocation configuration parameters comprising a first field, the first field indicating an upper limit for the number of the plurality of consecutive uplink subframes.
 14. A wireless device comprising:
 - one or more processors; and
 - memory storing instructions that, when executed by the one or more processors, cause the wireless device to:
 - receive one or more radio resource control (RRC) messages comprising configuration parameters for a licensed assisted access (LAA) cell;
 - receive a downlink control information (DCI) indicating uplink resources for an uplink burst comprising a number of a plurality of consecutive uplink subframes of the LAA cell, the DCI comprises:
 - the number of the plurality of consecutive uplink subframes in the uplink burst;
 - an assignment of a plurality of resource blocks; and
 - an ending symbol field for a physical uplink shared channel (PUSCH) indicating whether the PUSCH is transmitted in a last symbol of the uplink burst;
 - perform a listen before talk procedure indicating that a channel is clear for a starting subframe of the uplink burst; and
 - transmit, via the plurality of resource blocks used across the plurality of consecutive uplink subframes, one or more transport blocks in the PUSCH according to the ending symbol field.
 15. The wireless device of claim 14, wherein the ending symbol field is one bit.

16. The wireless device of claim 14, wherein the DCI further comprises at least one of:

- a modulation and coding scheme;
- a hybrid automatic repeat request (HARQ) identifier;
- a redundancy version (RV);
- a transmit power control (TPC) command; or
- a new data indicator (NDI).

17. The wireless device of claim 14, wherein the listen before talk procedure indicates that the channel is clear when a detected channel energy is below a threshold.

18. The wireless device of claim 14, wherein one or more parameters of the listen before talk procedure depends on a priority class of at least one of the one or more transport blocks.

19. The wireless device of claim 14, wherein, the instructions, when executed by the one or more processors, further cause the wireless device to transmit a sounding reference signal (SRS) in a subframe of the one or more consecutive uplink subframes.

20. The wireless device of claim 14, wherein the one or more RRC messages comprise one or more consecutive uplink subframe allocation configuration parameters comprising a first field, the first field indicating an upper limit for the number of the one or more consecutive uplink subframes.

* * * * *