



US 20170230945A1

(19) **United States**

(12) **Patent Application Publication**  
**Babaei et al.**

(10) **Pub. No.: US 2017/0230945 A1**

(43) **Pub. Date: Aug. 10, 2017**

(54) **MULTI-CARRIER DETECTION IN A WIRELESS NETWORK**

**Publication Classification**

(71) Applicant: **Ofinno Technologies, LLC**, Herndon, VA (US)

(51) **Int. Cl.**  
*H04W 72/04* (2006.01)  
*H04W 76/04* (2006.01)  
*H04W 72/08* (2006.01)

(72) Inventors: **Alireza Babaei**, Ashburn, VA (US);  
**Esmael Hejazi Dinan**, Herndon, VA (US)

(52) **U.S. Cl.**  
CPC ..... *H04W 72/042* (2013.01); *H04W 72/085* (2013.01); *H04W 76/046* (2013.01); *H04W 88/10* (2013.01)

(73) Assignee: **Ofinno Technologies, LLC**, Herndon, VA (US)

(57) **ABSTRACT**

(21) Appl. No.: **15/425,992**

The wireless device selects a first licensed assisted access (LAA) cell uniformly randomly from a plurality of LAA cells. The wireless device performs a first listen before talk (LBT) procedure for the first LAA cell employing a long monitoring period. The wireless device performs a second LBT procedure for a second LAA cell in the plurality of LAA cells employing a short monitoring period. The wireless device transmits to a base station one or more first transport blocks (TBs) on the first LAA cell and one or more second TBs on the second LAA cell.

(22) Filed: **Feb. 6, 2017**

**Related U.S. Application Data**

(60) Provisional application No. 62/291,387, filed on Feb. 4, 2016, provisional application No. 62/291,399, filed on Feb. 4, 2016.

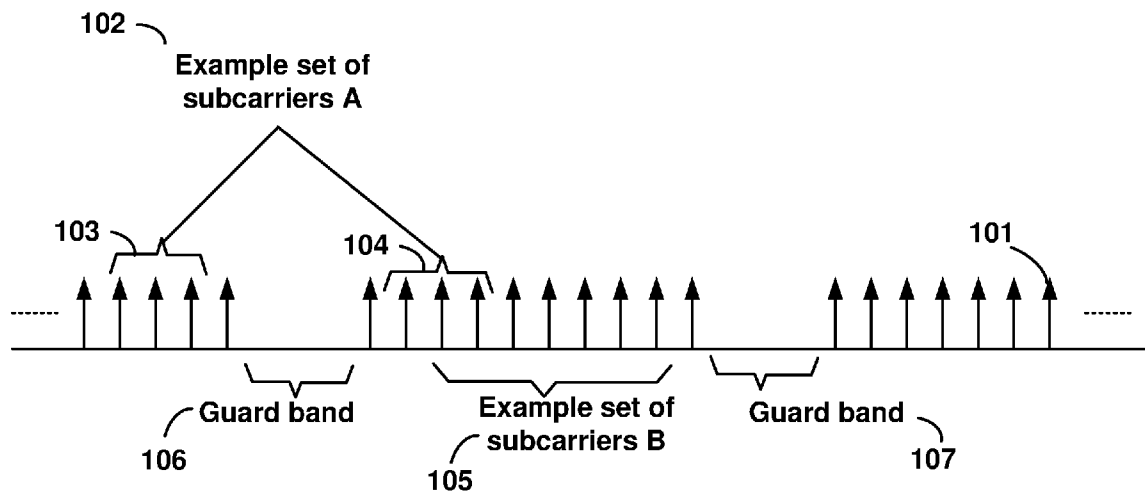

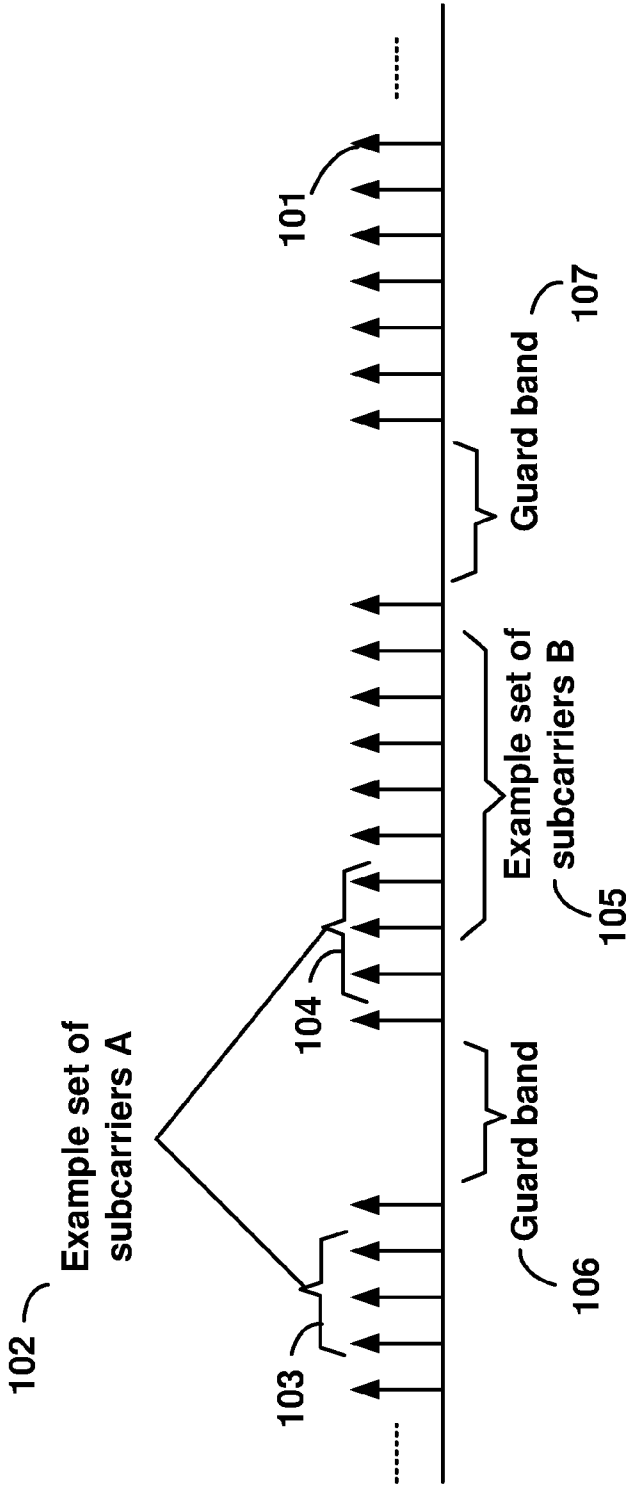

FIG. 1

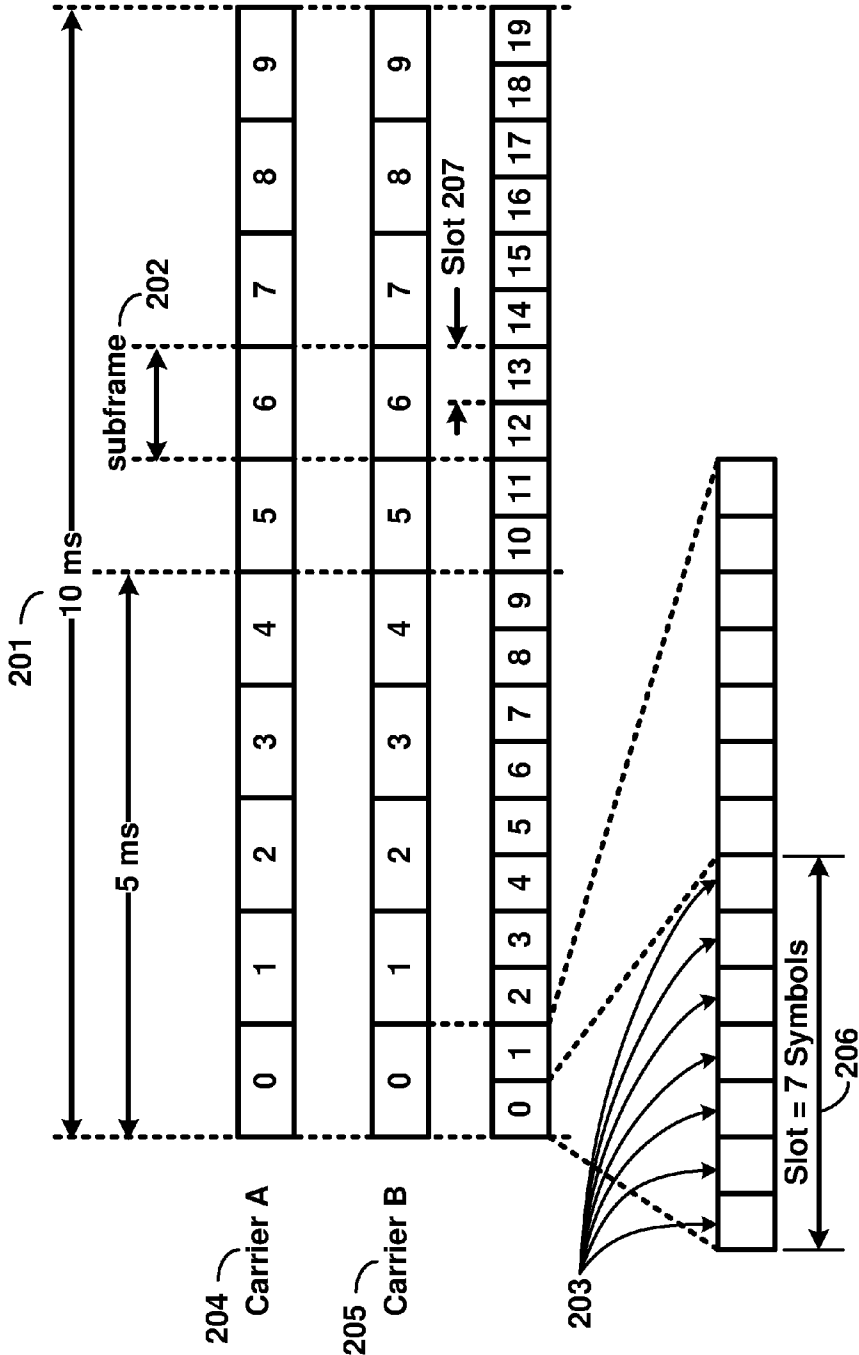

FIG. 2

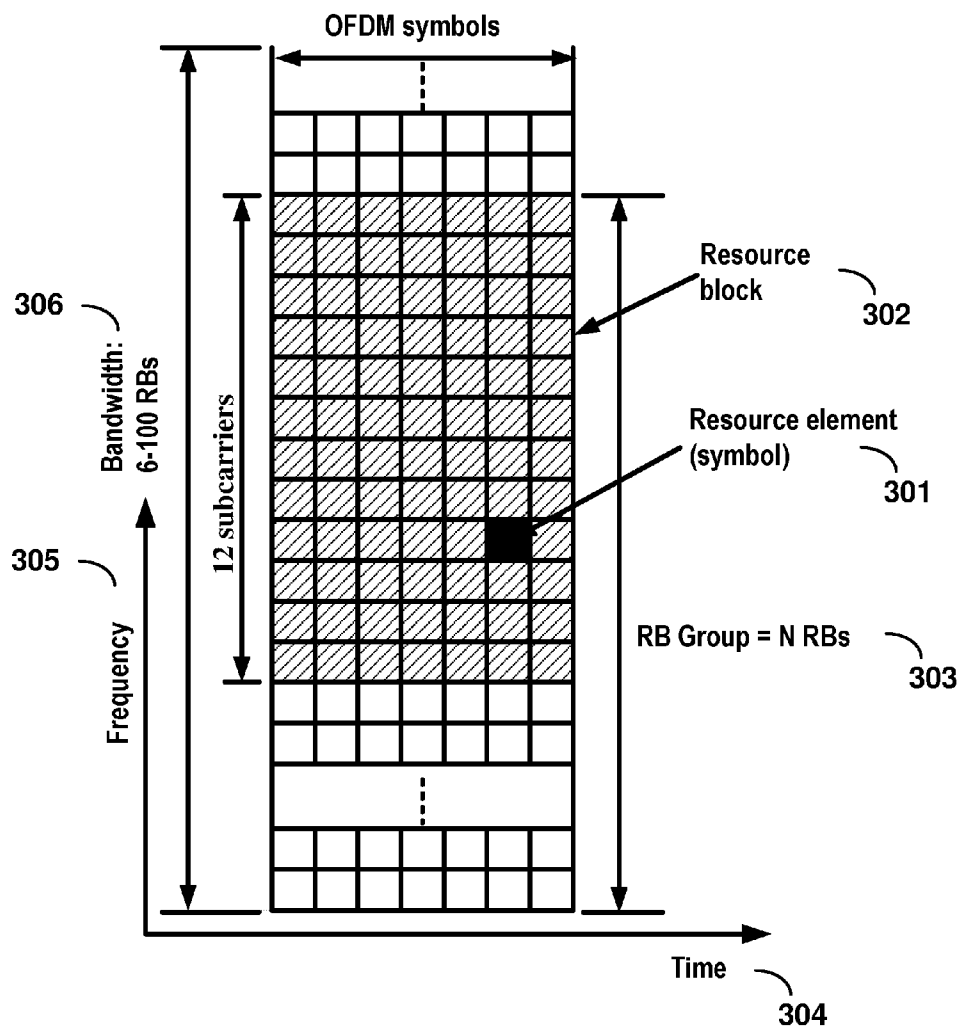

FIG. 3

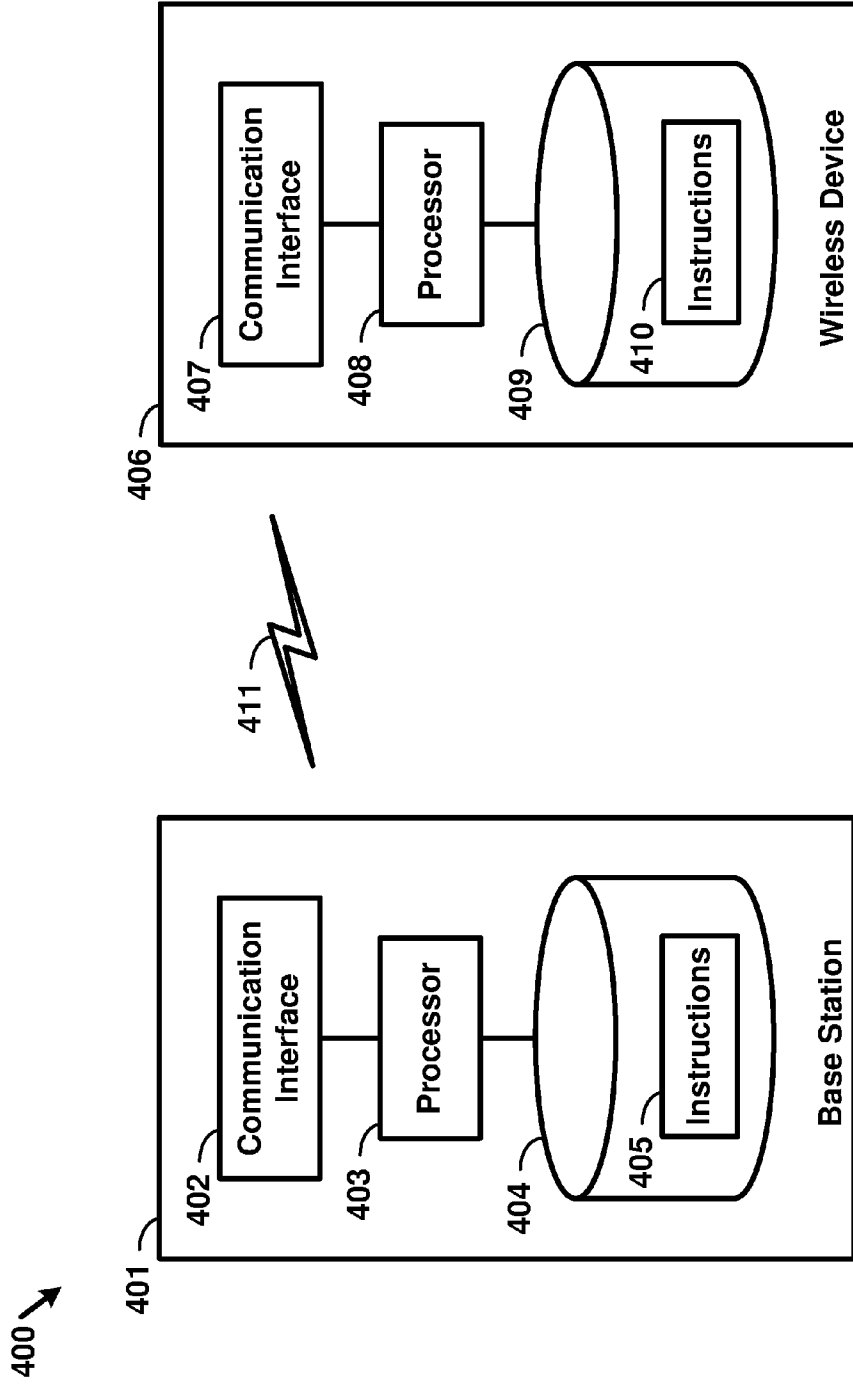

FIG. 4

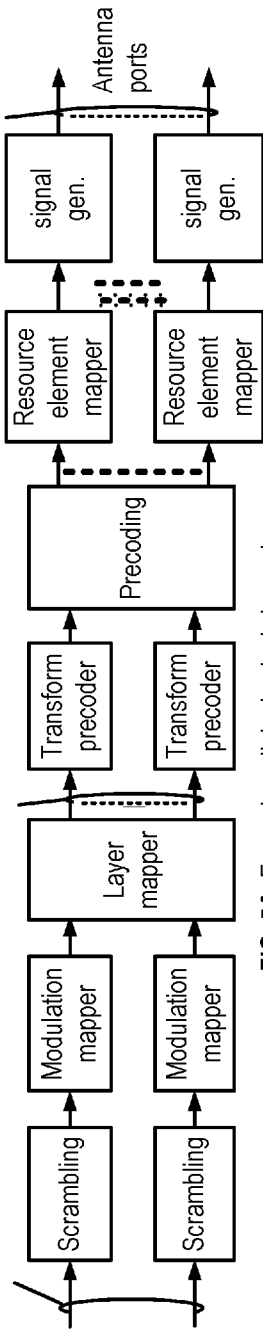

FIG. 5A Example uplink physical channel

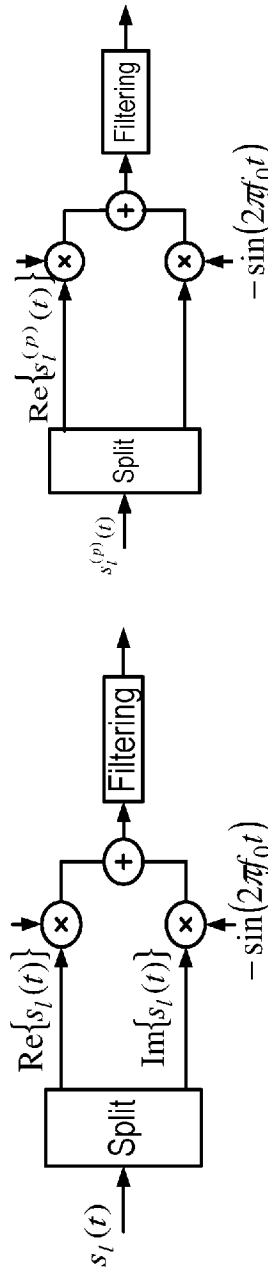

FIG. 5B Example uplink modulation

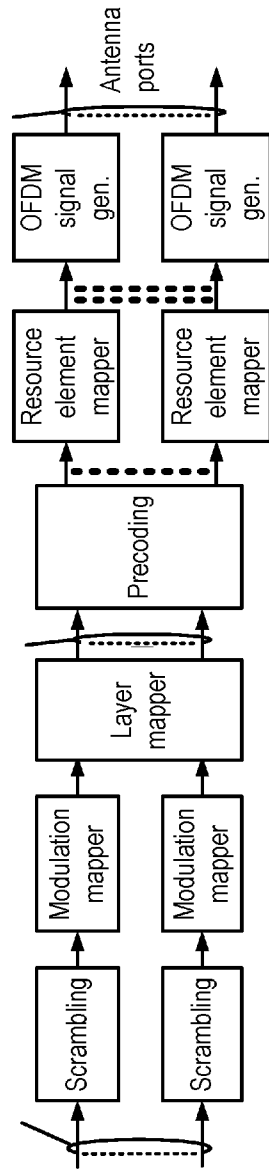

FIG. 5C Example downlink physical channel

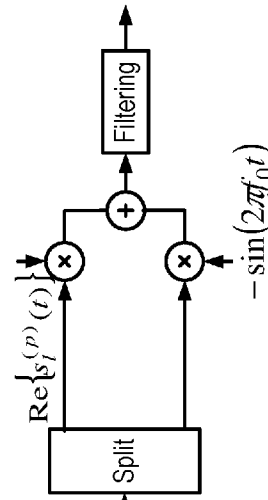
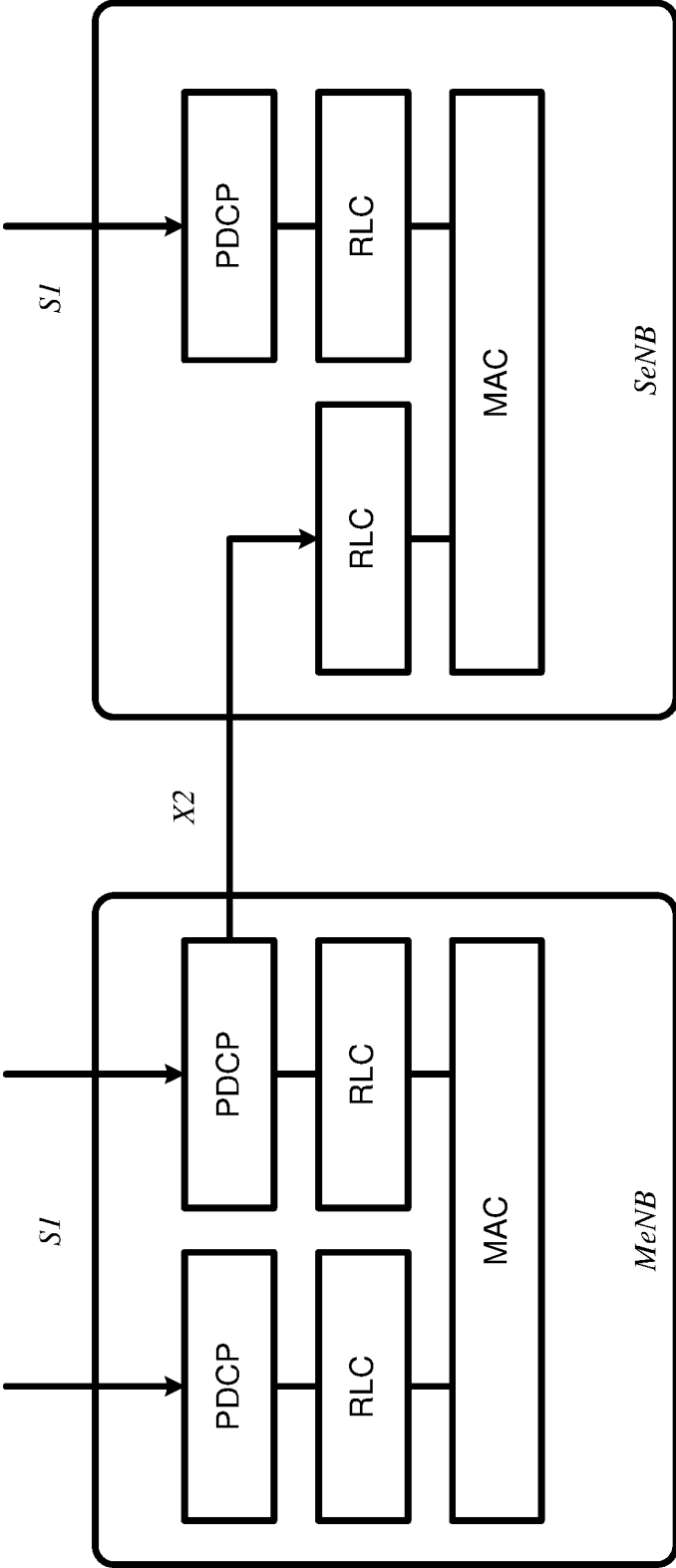
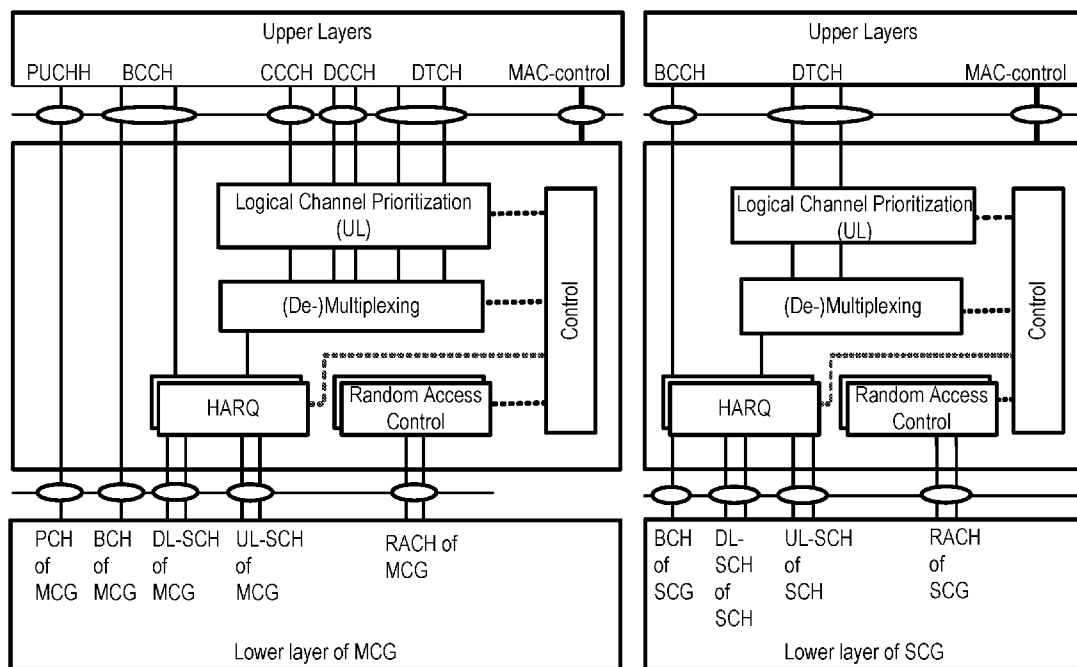

FIG. 5D Example downlink modulation



Dual-Connectivity at eNB

FIG. 6



Dual-Connectivity- two MAC entities at UE side

FIG. 7



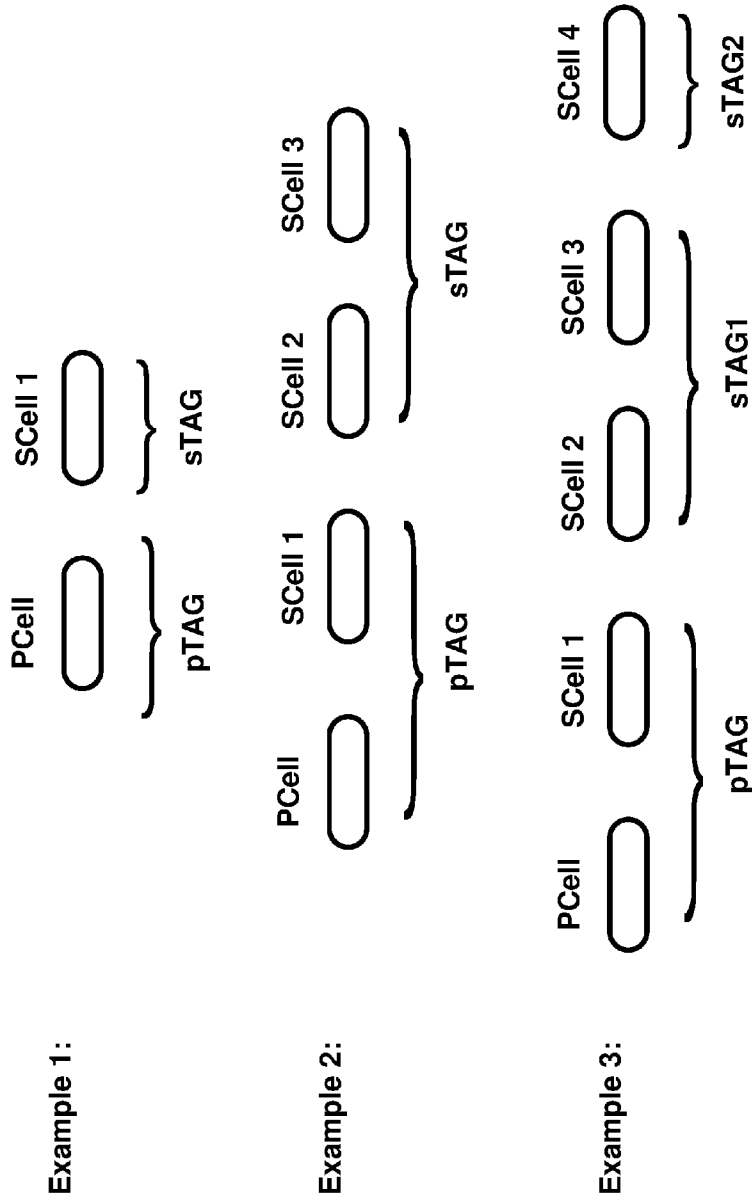

FIG. 8

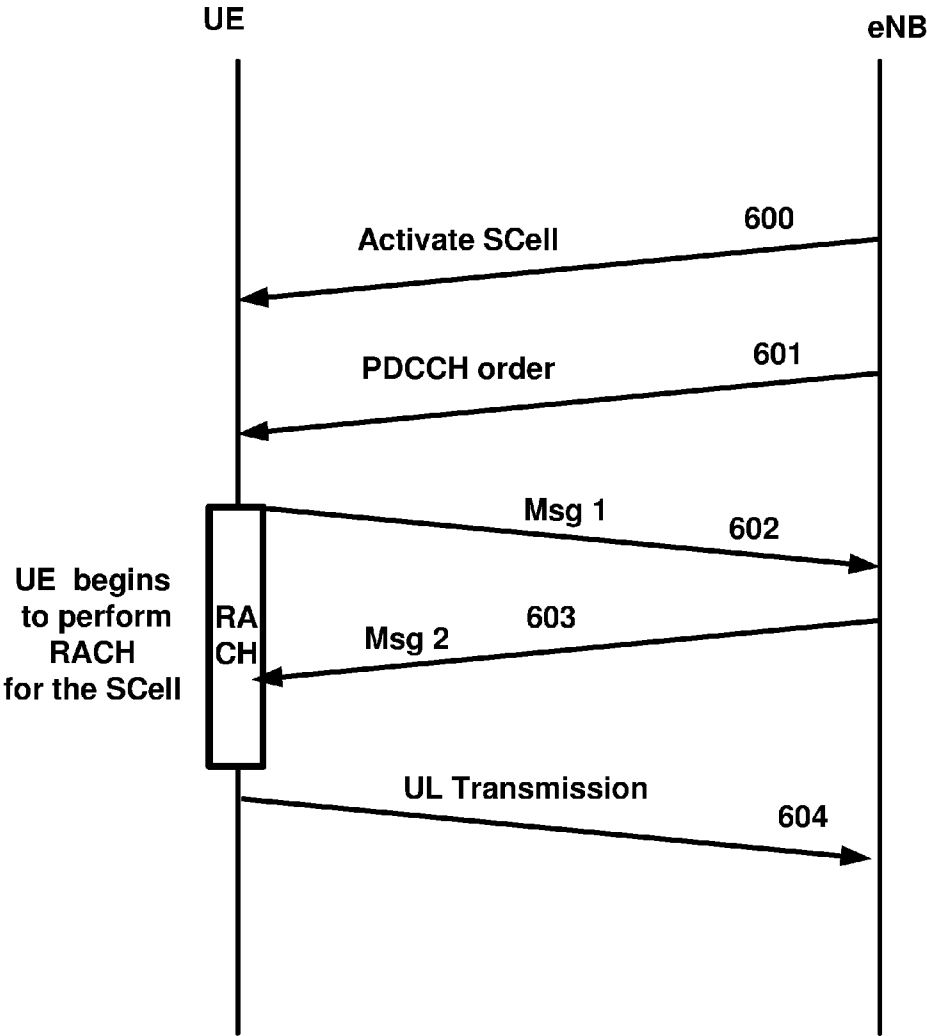

FIG. 9

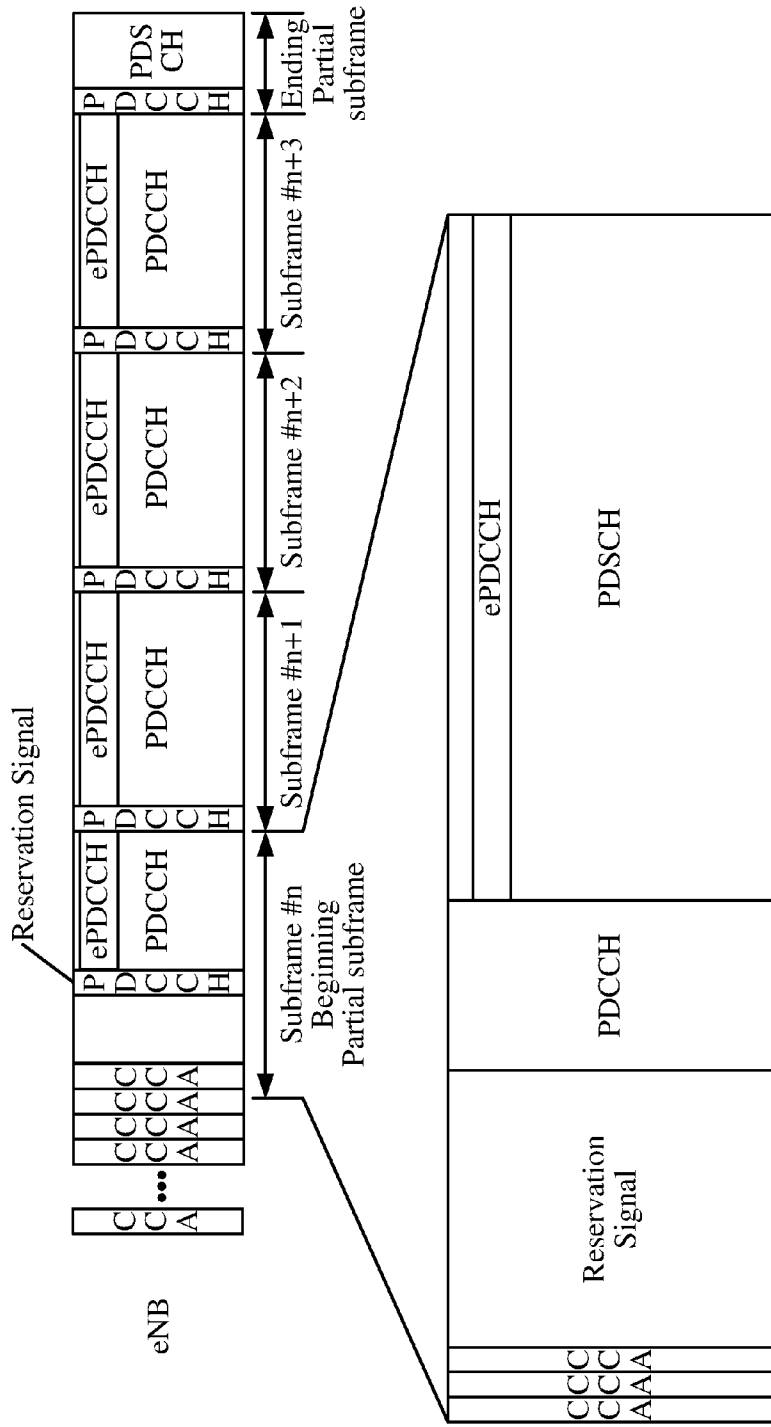

FIG. 10

Example configuration of special subframe (lengths of DwPTS/GP/UpPTS)

Special Subframe configuration	Normal cyclic prefix in downlink		Extended cyclic prefix in downlink		
	DwPTS	UpPTS	DwPTS	UpPTS	
		Normal cyclic prefix in downlink	Extended cyclic prefix in uplink	Normal cyclic prefix in downlink	Extended cyclic prefix in uplink
0	$6592 \cdot T_s$		$7680 \cdot T_s$		
1	$19760 \cdot T_s$		$20480 \cdot T_s$		$2560 \cdot T_s$
2	$21952 \cdot T_s$	$2192 \cdot T_s$	$23040 \cdot T_s$		$2192 \cdot T_s$
3	$24144 \cdot T_s$		$25600 \cdot T_s$		
4	$26366 \cdot T_s$		$7680 \cdot T_s$		
5	$6592 \cdot T_s$		$20480 \cdot T_s$		$4384 \cdot T_s$
6	$19760 \cdot T_s$		$23040 \cdot T_s$		
7	$21952 \cdot T_s$	$4384 \cdot T_s$	$12800 \cdot T_s$		$5120 \cdot T_s$
8	$24144 \cdot T_s$		-		-
9	$13168 \cdot T_s$		-		-

FIG. 11

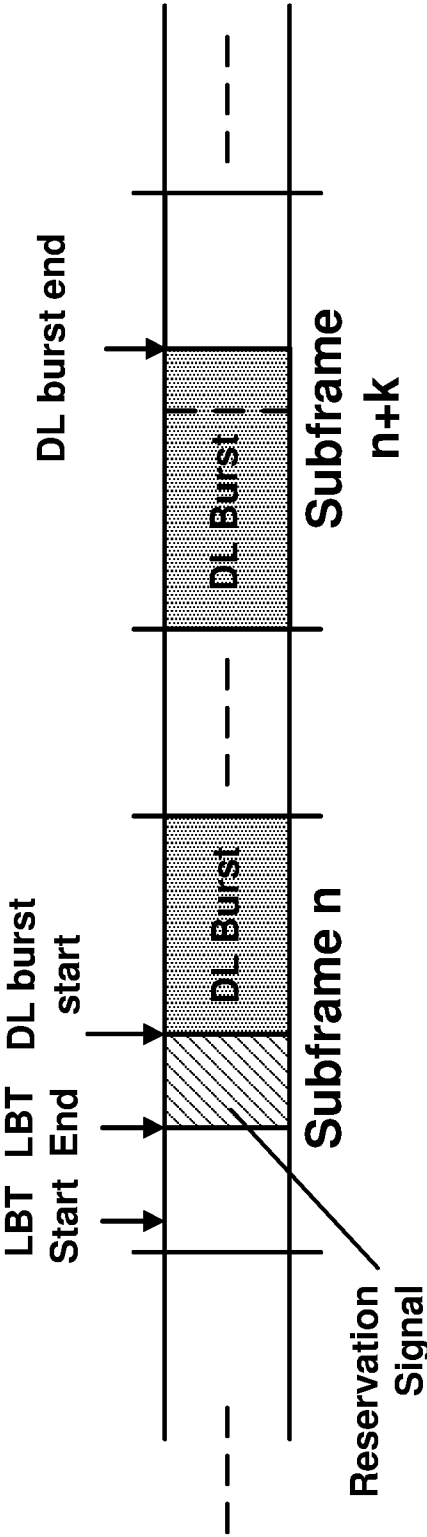

FIG. 12

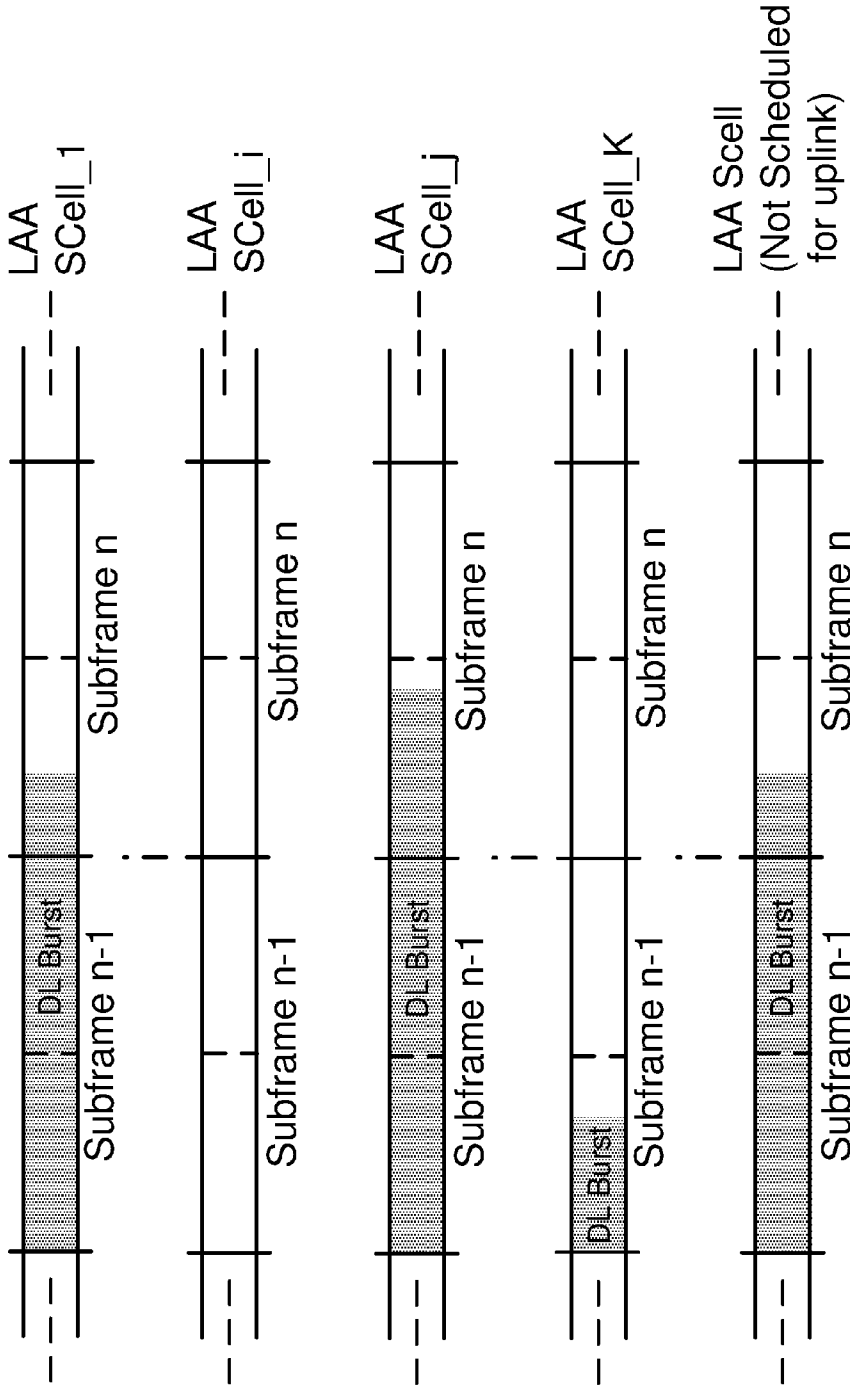

FIG. 13

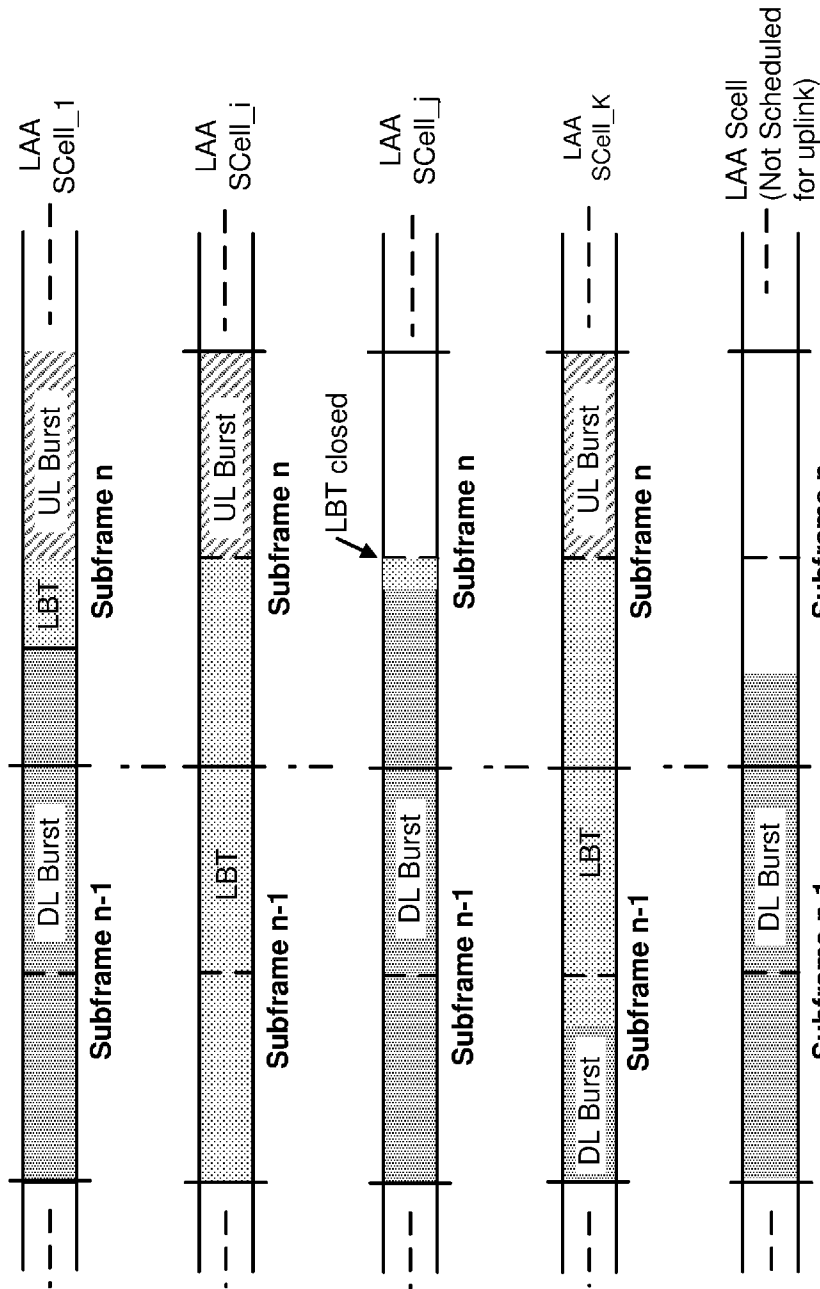

FIG. 14

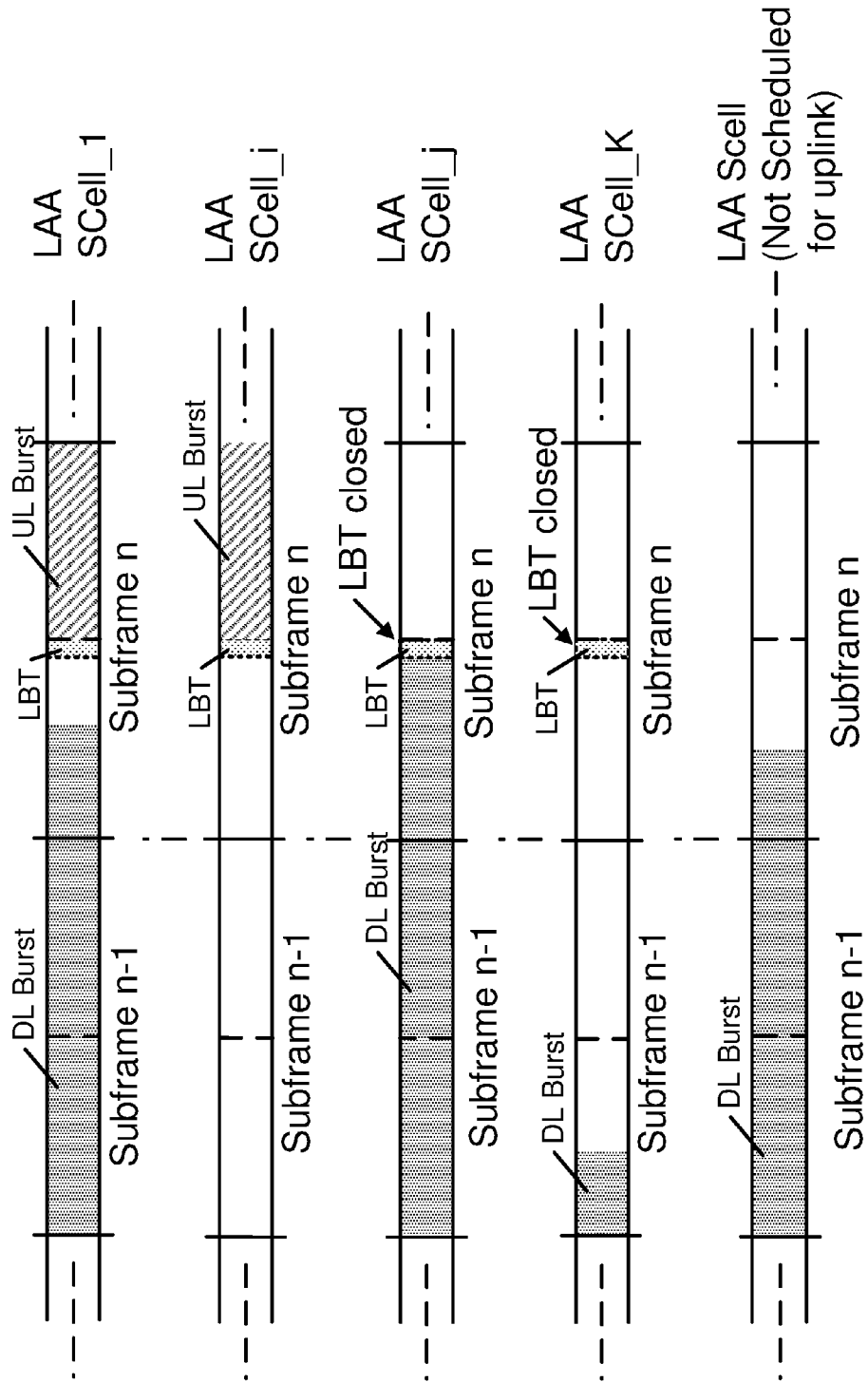

FIG. 15



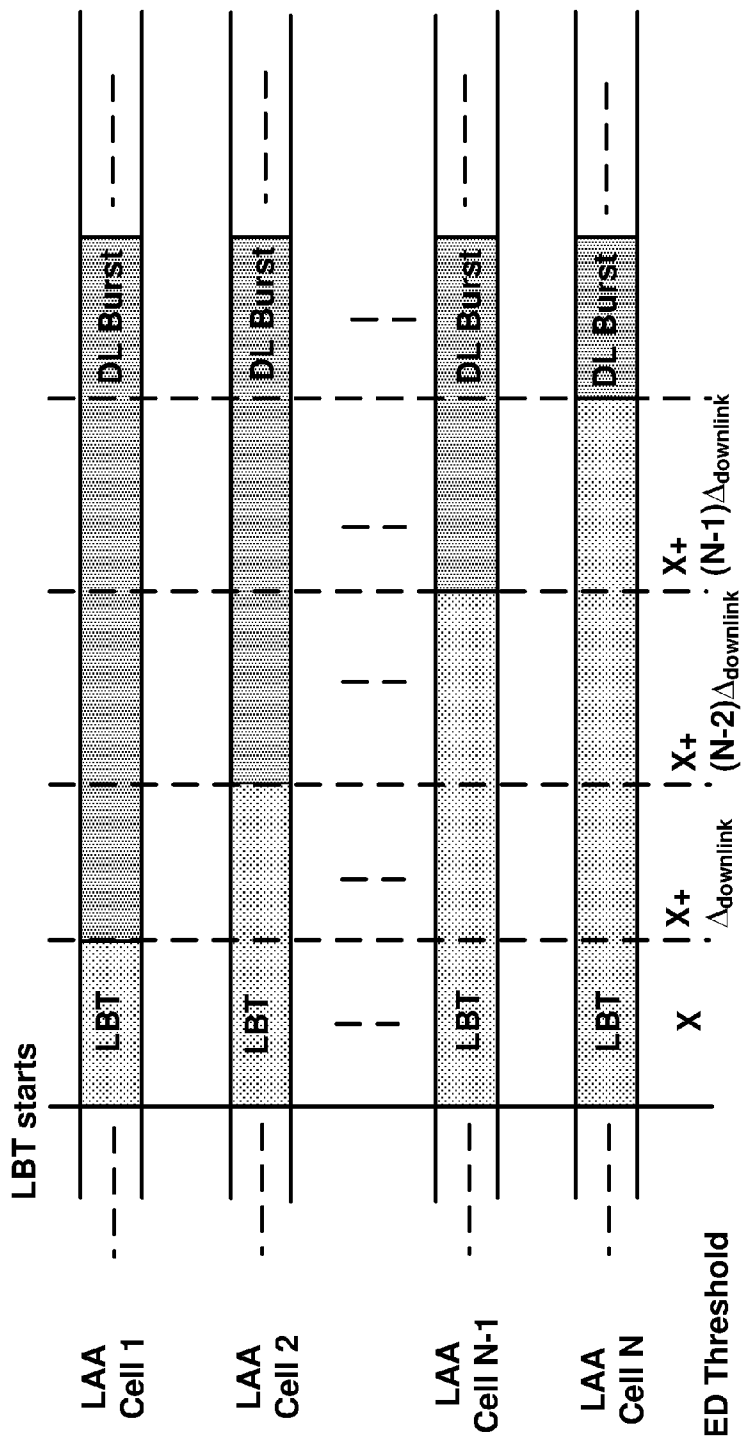

FIG. 16

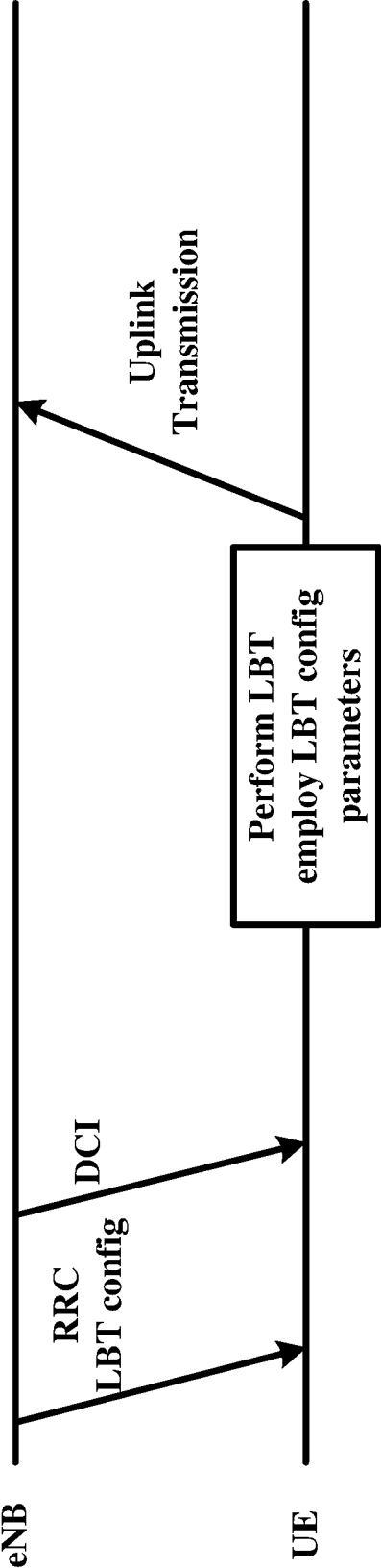

FIG. 17

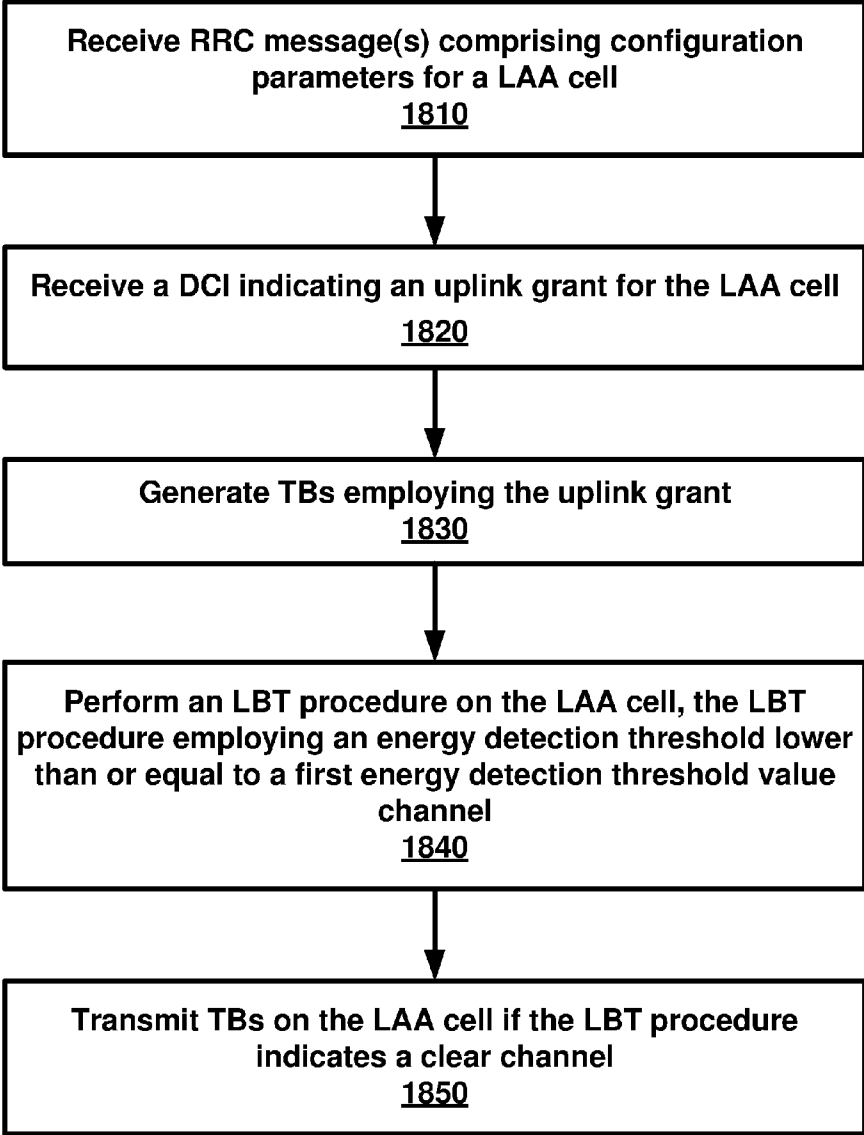

FIG. 18

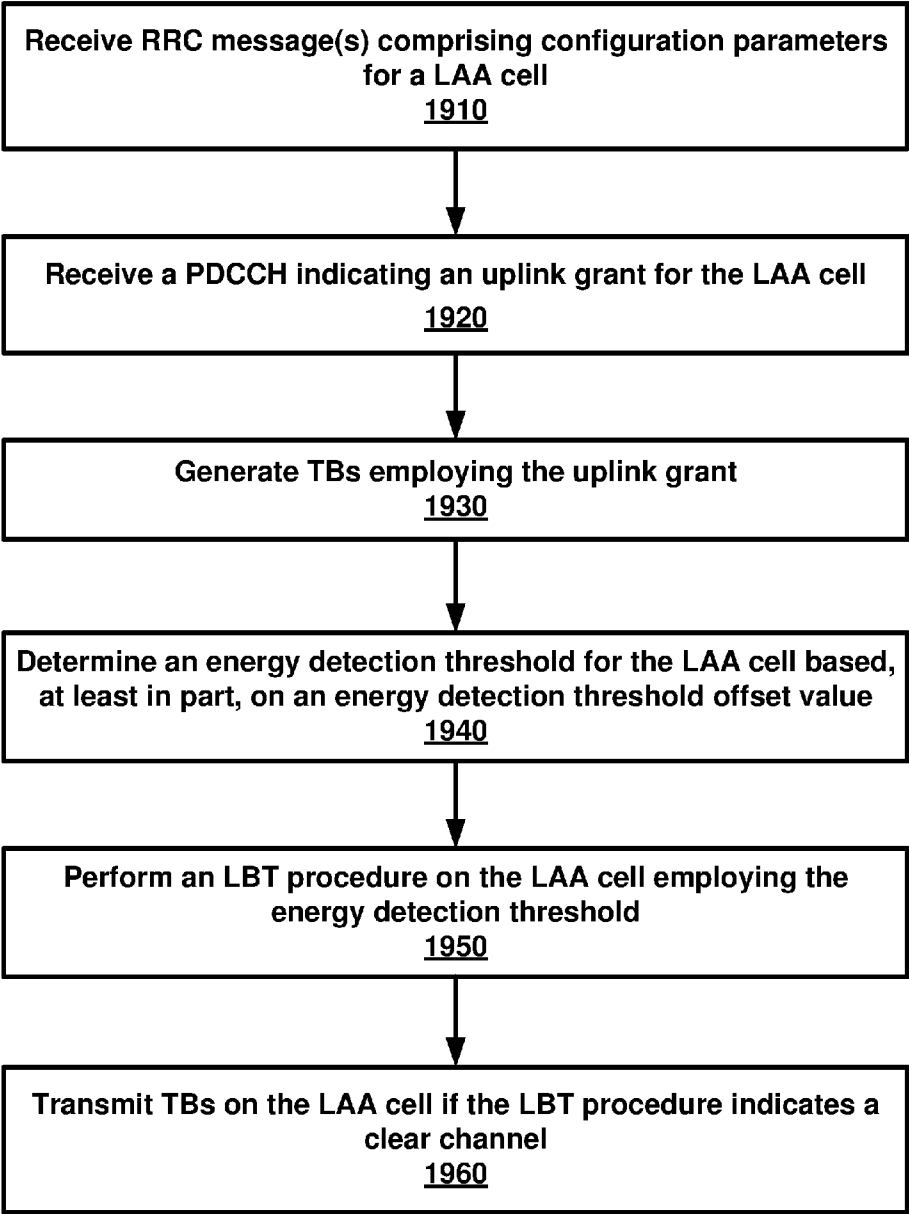

FIG. 19

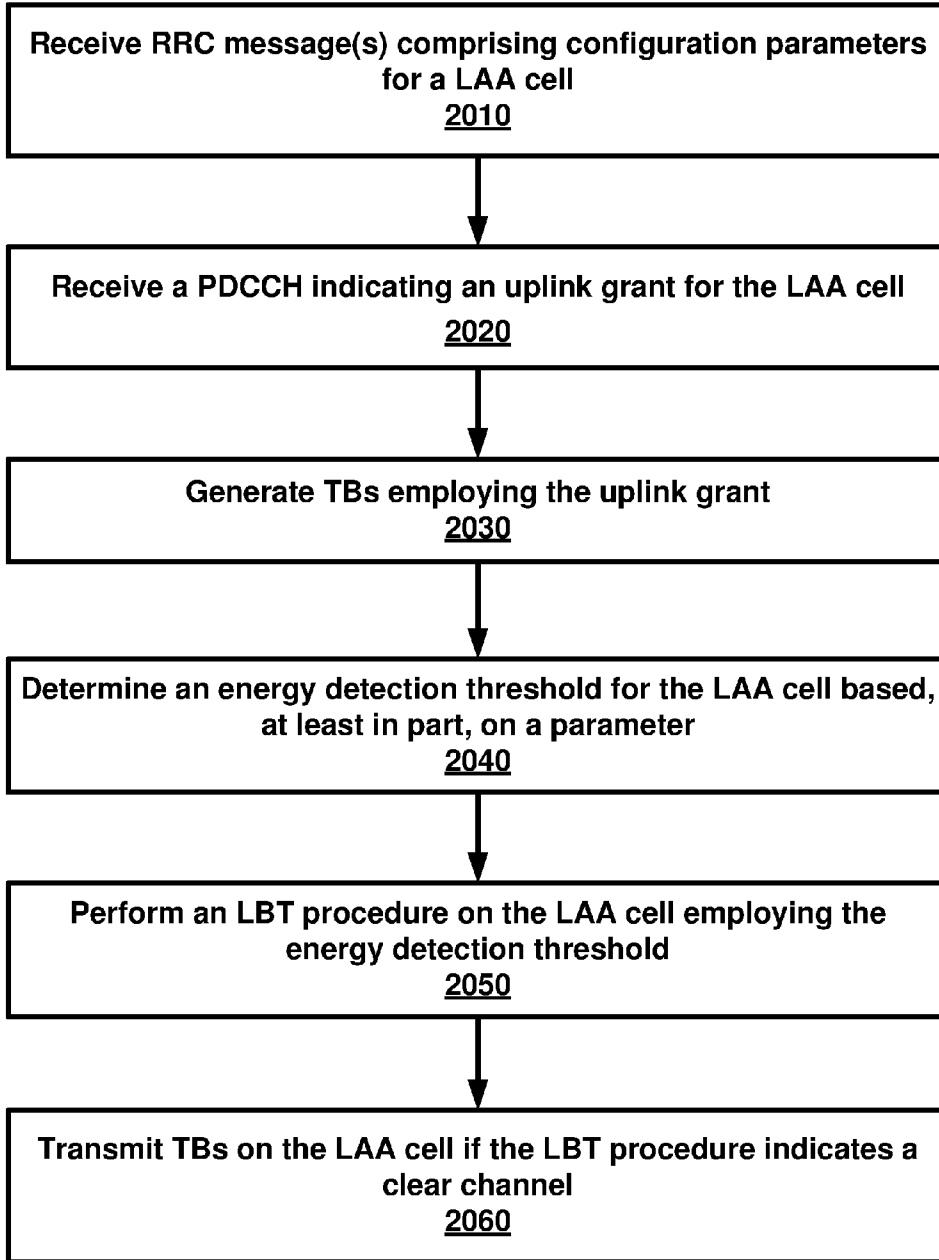

FIG. 20

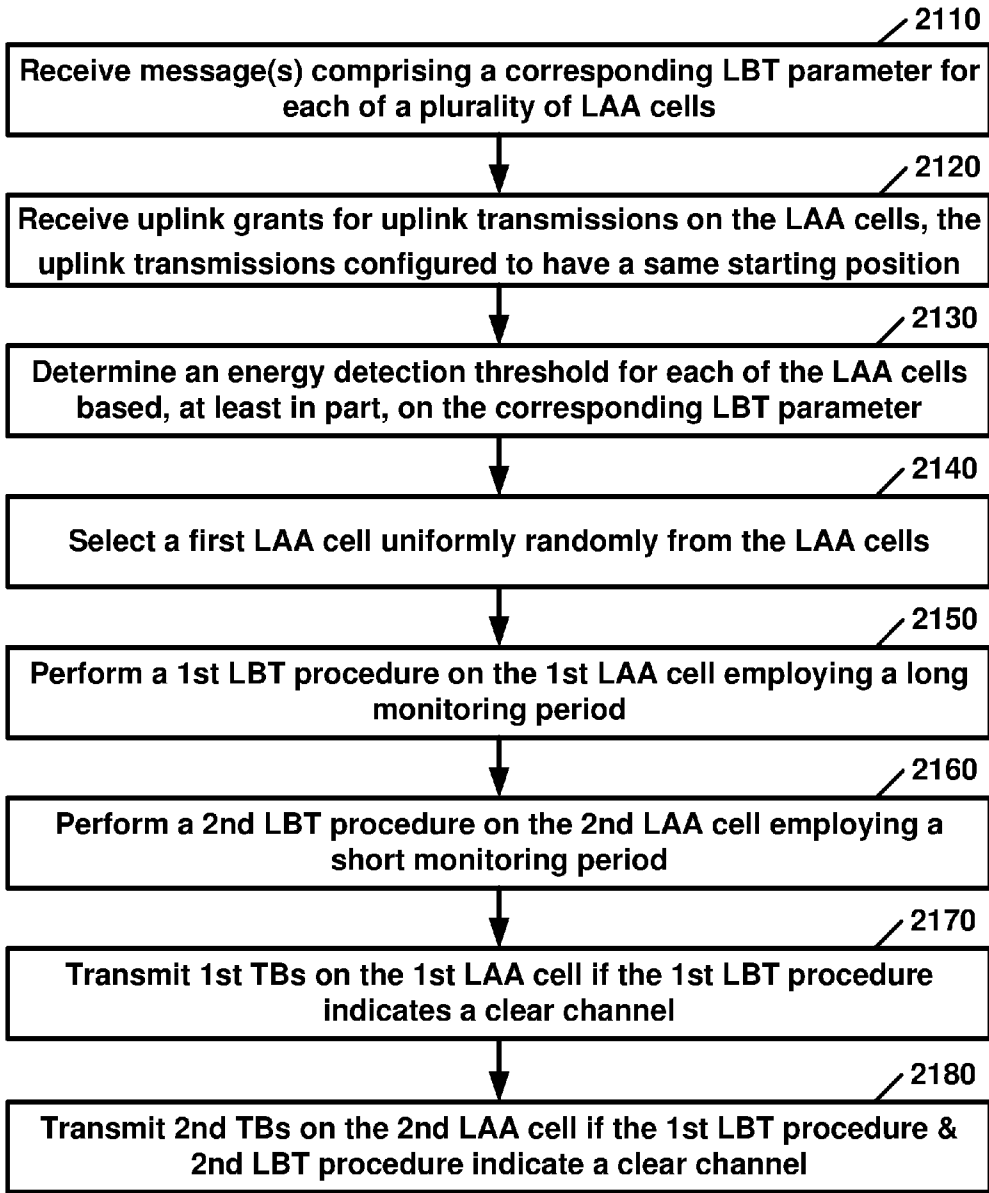

FIG. 21

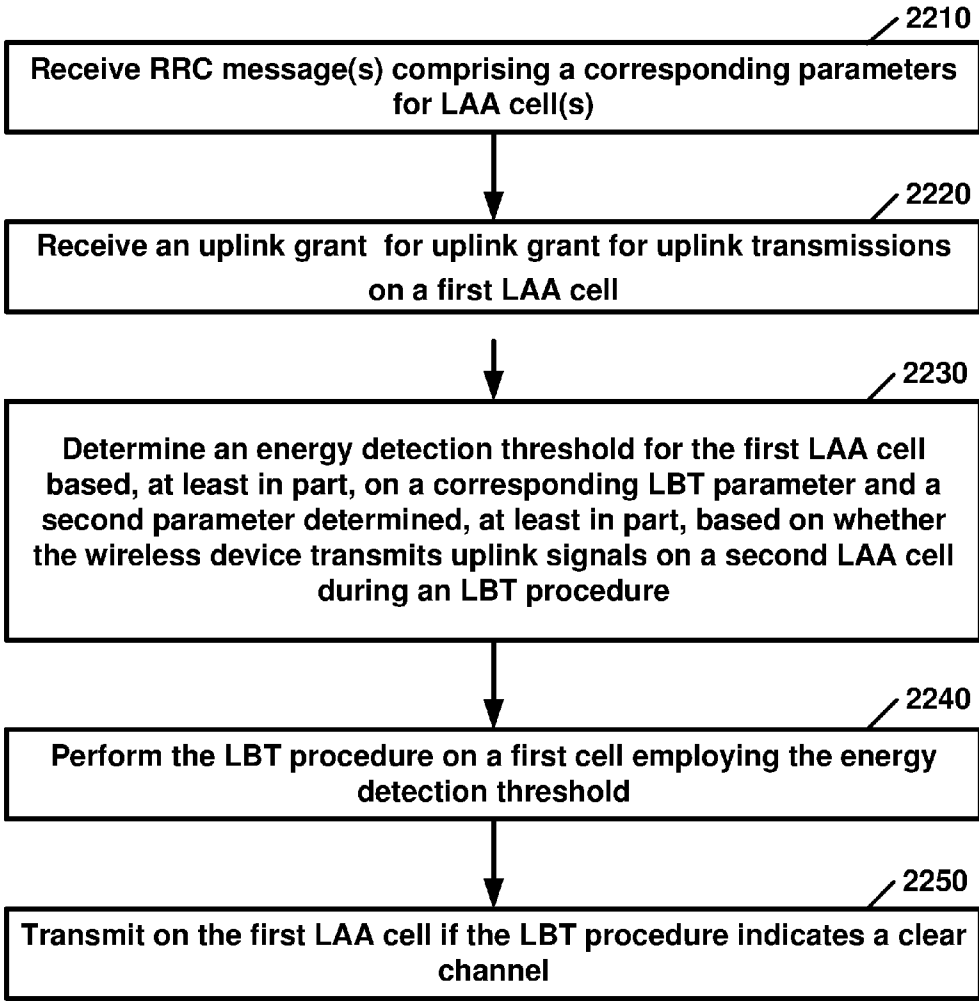

FIG. 22

**MULTI-CARRIER DETECTION IN A WIRELESS NETWORK**

**CROSS-REFERENCE TO RELATED APPLICATIONS**

[0001] This application claims the benefit of U.S. Provisional Application No. 62/291,387, filed Feb. 4, 2016, and U.S. Provisional Application No. 62/291,399, filed Feb. 4, 2016 which are hereby incorporated by reference in its entirety.

**BRIEF DESCRIPTION OF THE SEVERAL VIEWS OF THE DRAWINGS**

[0002] Examples of several of the various embodiments of the present disclosure are described herein with reference to the drawings.

[0003] FIG. 1 is a diagram depicting example sets of OFDM subcarriers as per an aspect of an embodiment of the present disclosure.

[0004] FIG. 2 is a diagram depicting an example transmission time and reception time for two carriers in a carrier group as per an aspect of an embodiment of the present disclosure.

[0005] FIG. 3 is an example diagram depicting OFDM radio resources as per an aspect of an embodiment of the present disclosure.

[0006] FIG. 4 is an example block diagram of a base station and a wireless device as per an aspect of an embodiment of the present disclosure.

[0007] FIG. 5A, FIG. 5B, FIG. 5C and FIG. 5D are example diagrams for uplink and downlink signal transmission as per an aspect of an embodiment of the present disclosure.

[0008] FIG. 6 is an example diagram for a protocol structure with CA and DC as per an aspect of an embodiment of the present disclosure.

[0009] FIG. 7 is an example diagram for a protocol structure with CA and DC as per an aspect of an embodiment of the present disclosure.

[0010] FIG. 8 shows example TAG configurations as per an aspect of an embodiment of the present disclosure.

[0011] FIG. 9 is an example message flow in a random access process in a secondary TAG as per an aspect of an embodiment of the present disclosure.

[0012] FIG. 10 is an example diagram depicting a downlink burst as per an aspect of an embodiment of the present disclosure.

[0013] FIG. 11 is an table showing example configuration of a subframe according to an embodiment of the present disclosure.

[0014] FIG. 12 is a diagram depicting an example listen before talk (LBT) procedure as per an aspect of an embodiment of the present disclosure.

[0015] FIG. 13 is a diagram depicting an example multi-carrier LBT procedure as per an aspect of an embodiment of the present disclosure.

[0016] FIG. 14 is a diagram depicting an example multi-carrier LBT procedure as per an aspect of an embodiment of the present disclosure.

[0017] FIG. 15 is a diagram depicting an example multi-carrier LBT procedure as per an aspect of an embodiment of the present disclosure.

[0018] FIG. 16 is an example diagram depicting energy detection threshold adaptation as per an aspect of an embodiment of the present disclosure.

[0019] FIG. 17 illustrates an example LBT procedure as per an aspect of an embodiment of the present disclosure.

[0020] FIG. 18 is an example flow diagram as per an aspect of an embodiment of the present disclosure.

[0021] FIG. 19 is an example flow diagram as per an aspect of an embodiment of the present disclosure.

[0022] FIG. 20 is an example flow diagram as per an aspect of an embodiment of the present disclosure.

[0023] FIG. 21 is an example flow diagram as per an aspect of an embodiment of the present disclosure.

[0024] FIG. 22 is an example flow diagram as per an aspect of an embodiment of the present disclosure.

**DETAILED DESCRIPTION OF EMBODIMENTS**

[0025] Example embodiments of the present disclosure enable operation of carrier aggregation. Embodiments of the technology disclosed herein may be employed in the technical field of multicarrier communication systems.

[0026] The following Acronyms are used throughout the present disclosure:

- [0027] ASIC application-specific integrated circuit
- [0028] BPSK binary phase shift keying
- [0029] CA carrier aggregation
- [0030] CSI channel state information
- [0031] CDMA code division multiple access
- [0032] CSS common search space
- [0033] CPLD complex programmable logic devices
- [0034] CC component carrier
- [0035] DL downlink
- [0036] DCI downlink control information
- [0037] DC dual connectivity
- [0038] EPC evolved packet core
- [0039] E-UTRAN evolved-universal terrestrial radio access network
- [0040] FPGA field programmable gate arrays
- [0041] FDD frequency division multiplexing
- [0042] HDL hardware description languages
- [0043] HARQ hybrid automatic repeat request
- [0044] IE information element
- [0045] LAA licensed assisted access
- [0046] LTE long term evolution
- [0047] MCG master cell group
- [0048] MeNB master evolved node B
- [0049] MIB master information block
- [0050] MAC media access control
- [0051] MAC media access control
- [0052] MME mobility management entity
- [0053] NAS non-access stratum
- [0054] OFDM orthogonal frequency division multiplexing
- [0055] PDCCP packet data convergence protocol
- [0056] PDU packet data unit
- [0057] PHY physical
- [0058] PDCCCH physical downlink control channel
- [0059] PHICH physical HARQ indicator channel
- [0060] PUCCH physical uplink control channel
- [0061] PUSCH physical uplink shared channel
- [0062] PCell primary cell
- [0063] PCell primary cell
- [0064] PCC primary component carrier
- [0065] PSCell primary secondary cell



[0066] pTAG primary timing advance group  
 [0067] QAM quadrature amplitude modulation  
 [0068] QPSK quadrature phase shift keying  
 [0069] RBG Resource Block Groups  
 [0070] RLC radio link control  
 [0071] RRC radio resource control  
 [0072] RA random access  
 [0073] RB resource blocks  
 [0074] SCC secondary component carrier  
 [0075] SCell secondary cell  
 [0076] Scell secondary cells  
 [0077] SCG secondary cell group  
 [0078] SeNB secondary evolved node B  
 [0079] sTAGs secondary timing advance group  
 [0080] SDU service data unit  
 [0081] S-GW serving gateway  
 [0082] SRB signaling radio bearer  
 [0083] SC-OFDM single carrier-OFDM  
 [0084] SFN system frame number  
 [0085] SIB system information block  
 [0086] TA tracking area identifier  
 [0087] TAT time alignment timer  
 [0088] TDD time division duplexing  
 [0089] TDMA time division multiple access  
 [0090] TA timing advance  
 [0091] TAG timing advance group  
 [0092] TB transport block  
 [0093] UL uplink  
 [0094] UE user equipment  
 [0095] VHDL VHSIC hardware description language  
 [0096] Example embodiments of the disclosure may be implemented using various physical layer modulation and transmission mechanisms. Example transmission mechanisms may include, but are not limited to: CDMA, OFDM, TDMA, Wavelet technologies, and/or the like. Hybrid transmission mechanisms such as TDMA/CDMA, and OFDM/CDMA may also be employed. Various modulation schemes may be applied for signal transmission in the physical layer. Examples of modulation schemes include, but are not limited to: phase, amplitude, code, a combination of these, and/or the like. An example radio transmission method may implement QAM using BPSK, QPSK, 16-QAM, 64-QAM, 256-QAM, and/or the like. Physical radio transmission may be enhanced by dynamically or semi-dynamically changing the modulation and coding scheme depending on transmission requirements and radio conditions.  
 [0097] FIG. 1 is a diagram depicting example sets of 01-DM subcarriers as per an aspect of an embodiment of the present disclosure. As illustrated in this example, arrow(s) in the diagram may depict a subcarrier in a multicarrier OFDM system. The OFDM system may use technology such as OFDM technology, DFTS-OFDM, SC-OFDM technology, or the like. For example, arrow 101 shows a subcarrier transmitting information symbols. FIG. 1 is for illustration purposes, and a typical multicarrier OFDM system may include more subcarriers in a carrier. For example, the number of subcarriers in a carrier may be in the range of 10 to 10,000 subcarriers. FIG. 1 shows two guard bands 106 and 107 in a transmission band. As illustrated in FIG. 1, guard band 106 is between subcarriers 103 and subcarriers 104. The example set of subcarriers A 102 includes subcarriers 103 and subcarriers 104. FIG. 1 also illustrates an example set of subcarriers B 105. As illustrated, there is no guard band between any two subcarriers in the example set

of subcarriers B 105. Carriers in a multicarrier OFDM communication system may be contiguous carriers, non-contiguous carriers, or a combination of both contiguous and non-contiguous carriers.

[0098] FIG. 2 is a diagram depicting an example transmission time and reception time for two carriers as per an aspect of an embodiment of the present disclosure. A multicarrier OFDM communication system may include one or more carriers, for example, ranging from 1 to 10 carriers. Carrier A 204 and carrier B 205 may have the same or different timing structures. Although FIG. 2 shows two synchronized carriers, carrier A 204 and carrier B 205 may or may not be synchronized with each other. Different radio frame structures may be supported for FDD and TDD duplex mechanisms. FIG. 2 shows an example FDD frame timing. Downlink and uplink transmissions may be organized into radio frames 201. In this example, the radio frame duration is 10 msec. Other frame durations, for example, in the range of 1 to 100 msec may also be supported. In this example, each 10 ms radio frame 201 may be divided into ten equally sized subframes 202. Other subframe durations such as 0.5 msec, 1 msec, 2 msec, and 5 msec may also be supported. Subframe(s) may consist of two or more slots (for example, slots 206 and 207). For the example of FDD, 10 subframes may be available for downlink transmission and 10 subframes may be available for uplink transmissions in each 10 ms interval. Uplink and downlink transmissions may be separated in the frequency domain. Slot(s) may include a plurality of OFDM symbols 203. The number of OFDM symbols 203 in a slot 206 may depend on the cyclic prefix length and subcarrier spacing.

[0099] FIG. 3 is a diagram depicting OFDM radio resources as per an aspect of an embodiment of the present disclosure. The resource grid structure in time 304 and frequency 305 is illustrated in FIG. 3. The quantity of downlink subcarriers or RBs (in this example 6 to 100 RBs) may depend, at least in part, on the downlink transmission bandwidth 306 configured in the cell. The smallest radio resource unit may be called a resource element (e.g. 301). Resource elements may be grouped into resource blocks (e.g. 302). Resource blocks may be grouped into larger radio resources called Resource Block Groups (RBG) (e.g. 303). The transmitted signal in slot 206 may be described by one or several resource grids of a plurality of subcarriers and a plurality of OFDM symbols. Resource blocks may be used to describe the mapping of certain physical channels to resource elements. Other pre-defined groupings of physical resource elements may be implemented in the system depending on the radio technology. For example, 24 subcarriers may be grouped as a radio block for a duration of 5 msec. In an illustrative example, a resource block may correspond to one slot in the time domain and 180 kHz in the frequency domain (for 15 KHz subcarrier bandwidth and 12 subcarriers).

[0100] FIG. 5A, FIG. 5B, FIG. 5C and FIG. 5D are example diagrams for uplink and downlink signal transmission as per an aspect of an embodiment of the present disclosure. FIG. 5A shows an example uplink physical channel. The baseband signal representing the physical uplink shared channel may perform the following processes. These functions are illustrated as examples and it is anticipated that other mechanisms may be implemented in various embodiments. The functions may comprise scrambling, modulation of scrambled bits to generate complex-valued

symbols, mapping of the complex-valued modulation symbols onto one or several transmission layers, transform precoding to generate complex-valued symbols, precoding of the complex-valued symbols, mapping of precoded complex-valued symbols to resource elements, generation of complex-valued time-domain DFTS-OFDM/SC-FDMA signal for each antenna port, and/or the like.

**[0101]** Example modulation and up-conversion to the carrier frequency of the complex-valued DFTS-OFDM/SC-FDMA baseband signal for each antenna port and/or the complex-valued PRACH baseband signal is shown in FIG. 5B. Filtering may be employed prior to transmission.

**[0102]** An example structure for Downlink Transmissions is shown in FIG. 5C. The baseband signal representing a downlink physical channel may perform the following processes. These functions are illustrated as examples and it is anticipated that other mechanisms may be implemented in various embodiments. The functions include scrambling of coded bits in each of the codewords to be transmitted on a physical channel; modulation of scrambled bits to generate complex-valued modulation symbols; mapping of the complex-valued modulation symbols onto one or several transmission layers; precoding of the complex-valued modulation symbols on each layer for transmission on the antenna ports; mapping of complex-valued modulation symbols for each antenna port to resource elements; generation of complex-valued time-domain OFDM signal for each antenna port, and/or the like.

**[0103]** Example modulation and up-conversion to the carrier frequency of the complex-valued OFDM baseband signal for each antenna port is shown in FIG. 5D. Filtering may be employed prior to transmission.

**[0104]** FIG. 4 is an example block diagram of a base station 401 and a wireless device 406, as per an aspect of an embodiment of the present disclosure. A communication network 400 may include at least one base station 401 and at least one wireless device 406. The base station 401 may include at least one communication interface 402, at least one processor 403, and at least one set of program code instructions 405 stored in non-transitory memory 404 and executable by the at least one processor 403. The wireless device 406 may include at least one communication interface 407, at least one processor 408, and at least one set of program code instructions 410 stored in non-transitory memory 409 and executable by the at least one processor 408. Communication interface 402 in base station 401 may be configured to engage in communication with communication interface 407 in wireless device 406 via a communication path that includes at least one wireless link 411. Wireless link 411 may be a bi-directional link. Communication interface 407 in wireless device 406 may also be configured to engage in a communication with communication interface 402 in base station 401. Base station 401 and wireless device 406 may be configured to send and receive data over wireless link 411 using multiple frequency carriers. According to aspects of an embodiment, transceiver(s) may be employed. A transceiver is a device that includes both a transmitter and receiver. Transceivers may be employed in devices such as wireless devices, base stations, relay nodes, and/or the like. Example embodiments for radio technology implemented in communication interface 402, 407 and wireless link 411 are illustrated are FIG. 1, FIG. 2, FIG. 3, FIG. 5, and associated text.

**[0105]** An interface may be a hardware interface, a firmware interface, a software interface, and/or a combination thereof. The hardware interface may include connectors, wires, electronic devices such as drivers, amplifiers, and/or the like. A software interface may include code stored in a memory device to implement protocol(s), protocol layers, communication drivers, device drivers, combinations thereof, and/or the like. A firmware interface may include a combination of embedded hardware and code stored in and/or in communication with a memory device to implement connections, electronic device operations, protocol(s), protocol layers, communication drivers, device drivers, hardware operations, combinations thereof, and/or the like.

**[0106]** The term configured may relate to the capacity of a device whether the device is in an operational or non-operational state. Configured may also refer to specific settings in a device that effect the operational characteristics of the device whether the device is in an operational or non-operational state. In other words, the hardware, software, firmware, registers, memory values, and/or the like may be “configured” within a device, whether the device is in an operational or nonoperational state, to provide the device with specific characteristics. Terms such as “a control message to cause in a device” may mean that a control message has parameters that may be used to configure specific characteristics in the device, whether the device is in an operational or non-operational state.

**[0107]** According to various aspects of an embodiment, an LTE network may include a multitude of base stations, providing a user plane PDCP/RLC/MAC/PHY and control plane (RRC) protocol terminations towards the wireless device. The base station(s) may be interconnected with other base station(s) (for example, interconnected employing an X2 interface). Base stations may also be connected employing, for example, an S1 interface to an EPC. For example, base stations may be interconnected to the MME employing the S1-MME interface and to the S-G) employing the S1-U interface. The S1 interface may support a many-to-many relation between MMEs/Serving Gateways and base stations. A base station may include many sectors for example: 1, 2, 3, 4, or 6 sectors. A base station may include many cells, for example, ranging from 1 to 50 cells or more. A cell may be categorized, for example, as a primary cell or secondary cell. At RRC connection establishment/re-establishment/handover, one serving cell may provide the NAS (non-access stratum) mobility information (e.g. TAI), and at RRC connection re-establishment/handover, one serving cell may provide the security input. This cell may be referred to as the Primary Cell (PCell). In the downlink, the carrier corresponding to the PCell may be the Downlink Primary Component Carrier (DL PCC), while in the uplink, the carrier corresponding to the PCell may be the Uplink Primary Component Carrier (UL PCC). Depending on wireless device capabilities, Secondary Cells (SCells) may be configured to form together with the PCell a set of serving cells. In the downlink, the carrier corresponding to an SCell may be a Downlink Secondary Component Carrier (DL SCC), while in the uplink, it may be an Uplink Secondary Component Carrier (UL SCC). An SCell may or may not have an uplink carrier.

**[0108]** A cell, comprising a downlink carrier and optionally an uplink carrier, may be assigned a physical cell ID and a cell index. A carrier (downlink or uplink) may belong to only one cell. The cell ID or Cell index may also identify the

downlink carrier or uplink carrier of the cell (depending on the context it is used). In the specification, cell ID may be equally referred to a carrier ID, and cell index may be referred to carrier index. In implementation, the physical cell ID or cell index may be assigned to a cell. A cell ID may be determined using a synchronization signal transmitted on a downlink carrier. A cell index may be determined using RRC messages. For example, when the specification refers to a first physical cell ID for a first downlink carrier, the specification may mean the first physical cell ID is for a cell comprising the first downlink carrier. The same concept may apply, for example, to carrier activation. When the specification indicates that a first carrier is activated, the specification may also mean that the cell comprising the first carrier is activated.

**[0109]** Embodiments may be configured to operate as needed. The disclosed mechanism may be performed when certain criteria are met, for example, in a wireless device, a base station, a radio environment, a network, a combination of the above, and/or the like. Example criteria may be based, at least in part, on for example, traffic load, initial system set up, packet sizes, traffic characteristics, a combination of the above, and/or the like. When the one or more criteria are met, various example embodiments may be applied. Therefore, it may be possible to implement example embodiments that selectively implement disclosed protocols.

**[0110]** A base station may communicate with a mix of wireless devices. Wireless devices may support multiple technologies, and/or multiple releases of the same technology. Wireless devices may have some specific capability(ies) depending on its wireless device category and/or capability(ies). A base station may comprise multiple sectors. When this disclosure refers to a base station communicating with a plurality of wireless devices, this disclosure may refer to a subset of the total wireless devices in a coverage area. This disclosure may refer to, for example, a plurality of wireless devices of a given LTE release with a given capability and in a given sector of the base station. The plurality of wireless devices in this disclosure may refer to a selected plurality of wireless devices, and/or a subset of total wireless devices in a coverage area which perform according to disclosed methods, and/or the like. There may be a plurality of wireless devices in a coverage area that may not comply with the disclosed methods, for example, because those wireless devices perform based on older releases of LTE technology.

**[0111]** FIG. 6 and FIG. 7 are example diagrams for protocol structure with CA and DC as per an aspect of an embodiment of the present disclosure. E-UTRAN may support Dual Connectivity (DC) operation whereby a multiple RX/TX UE in RRC\_CONNECTED may be configured to utilize radio resources provided by two schedulers located in two eNBs connected via a non-ideal backhaul over the X2 interface. eNBs involved in DC for a certain UE may assume two different roles: an eNB may either act as an MeNB or as an SeNB. In DC a UE may be connected to one MeNB and one SeNB. Mechanisms implemented in DC may be extended to cover more than two eNBs. FIG. 7 illustrates one example structure for the UE side MAC entities when a Master Cell Group (MCG) and a Secondary Cell Group (SCG) are configured, and it may not restrict implementation. Media Broadcast Multicast Service (MBMS) reception is not shown in this figure for simplicity.

**[0112]** In DC, the radio protocol architecture that a particular bearer uses may depend on how the bearer is setup. Three alternatives may exist, an MCG bearer, an SCG bearer and a split bearer as shown in FIG. 6. RRC may be located in MeNB and SRBs may be configured as a MCG bearer type and may use the radio resources of the MeNB. DC may also be described as having at least one bearer configured to use radio resources provided by the SeNB. DC may or may not be configured/implemented in example embodiments of the disclosure.

**[0113]** In the case of DC, the UE may be configured with two MAC entities: one MAC entity for MeNB, and one MAC entity for SeNB. In DC, the configured set of serving cells for a UE may comprise two subsets: the Master Cell Group (MCG) containing the serving cells of the MeNB, and the Secondary Cell Group (SCG) containing the serving cells of the SeNB. For a SCG, one or more of the following may be applied. At least one cell in the SCG may have a configured UL CC and one of them, named PSCell (or PCell of SCG, or sometimes called PCell), may be configured with PUCCH resources. When the SCG is configured, there may be at least one SCG bearer or one Split bearer. Upon detection of a physical layer problem or a random access problem on a PSCell, or the maximum number of RLC retransmissions has been reached associated with the SCG, or upon detection of an access problem on a PSCell during a SCG addition or a SCG change: a RRC connection re-establishment procedure may not be triggered, UL transmissions towards cells of the SCG may be stopped, and a MeNB may be informed by the UE of a SCG failure type. For split bearer, the DL data transfer over the MeNB may be maintained. The RLC AM bearer may be configured for the split bearer. Like a PCell, a PSCell may not be de-activated. A PSCell may be changed with a SCG change (for example, with a security key change and a RACH procedure), and/or neither a direct bearer type change between a Split bearer and a SCG bearer nor simultaneous configuration of a SCG and a Split bearer may be supported.

**[0114]** With respect to the interaction between a MeNB and a SeNB, one or more of the following principles may be applied. The MeNB may maintain the RRM measurement configuration of the UE and may, (for example, based on received measurement reports or traffic conditions or bearer types), decide to ask a SeNB to provide additional resources (serving cells) for a UE. Upon receiving a request from the MeNB, a SeNB may create a container that may result in the configuration of additional serving cells for the UE (or decide that it has no resource available to do so). For UE capability coordination, the MeNB may provide (part of) the AS configuration and the UE capabilities to the SeNB. The MeNB and the SeNB may exchange information about a UE configuration by employing RRC containers (inter-node messages) carried in X2 messages. The SeNB may initiate a reconfiguration of its existing serving cells (for example, a PUCCH towards the SeNB). The SeNB may decide which cell is the PSCell within the SCG. The MeNB may not change the content of the RRC configuration provided by the SeNB. In the case of a SCG addition and a SCG SCell addition, the MeNB may provide the latest measurement results for the SCG cell(s). Both a MeNB and a SeNB may know the SFN and subframe offset of each other by OAM, (for example, for the purpose of DRX alignment and identification of a measurement gap). In an example, when adding a new SCG SCell, dedicated RRC signaling may be

used for sending required system information of the cell as for CA, except for the SFN acquired from a MIB of the PSCell of a SCG.

**[0115]** In an example, serving cells may be grouped in a TA group (TAG). Serving cells in one TAG may use the same timing reference. For a given TAG, user equipment (UE) may use at least one downlink carrier as a timing reference. For a given TAG, a UE may synchronize uplink subframe and frame transmission timing of uplink carriers belonging to the same TAG. In an example, serving cells having an uplink to which the same TA applies may correspond to serving cells hosted by the same receiver. A UE supporting multiple TAs may support two or more TA groups. One TA group may contain the PCell and may be called a primary TAG (pTAG). In a multiple TAG configuration, at least one TA group may not contain the PCell and may be called a secondary TAG (sTAG). In an example, carriers within the same TA group may use the same TA value and/or the same timing reference. When DC is configured, cells belonging to a cell group (MCG or SCG) may be grouped into multiple TAGs including a pTAG and one or more sTAGs.

**[0116]** FIG. 8 shows example TAG configurations as per an aspect of an embodiment of the present disclosure. In Example 1, pTAG comprises a PCell, and an sTAG comprises SCell1. In Example 2, a pTAG comprises a PCell and SCell1, and an sTAG comprises SCell2 and SCell3. In Example 3, pTAG comprises PCell and SCell1, and an sTAG1 includes SCell2 and SCell3, and sTAG2 comprises SCell4. Up to four TAGs may be supported in a cell group (MCG or SCG) and other example TAG configurations may also be provided. In various examples in this disclosure, example mechanisms are described for a pTAG and an sTAG. Some of the example mechanisms may be applied to configurations with multiple sTAGs.

**[0117]** In an example, an eNB may initiate an RA procedure via a PDCCH order for an activated SCell. This PDCCH order may be sent on a scheduling cell of this SCell. When cross carrier scheduling is configured for a cell, the scheduling cell may be different than the cell that is employed for preamble transmission, and the PDCCH order may include an SCell index. At least a non-contention based RA procedure may be supported for SCell(s) assigned to sTAG(s).

**[0118]** FIG. 9 is an example message flow in a random access process in a secondary TAG as per an aspect of an embodiment of the present disclosure. An eNB transmits an activation command **600** to activate an SCell. A preamble **602** (Msg1) may be sent by a UE in response to a PDCCH order **601** on an SCell belonging to an sTAG. In an example embodiment, preamble transmission for SCells may be controlled by the network using PDCCH format 1A. Msg2 message **603** (RAR: random access response) in response to the preamble transmission on the SCell may be addressed to RA-RNTI in a PCell common search space (CSS). Uplink packets **604** may be transmitted on the SCell in which the preamble was transmitted.

**[0119]** According to an embodiment, initial timing alignment may be achieved through a random access procedure. This may involve a UE transmitting a random access preamble and an eNB responding with an initial TA command NTA (amount of timing advance) within a random access response window. The start of the random access preamble may be aligned with the start of a corresponding uplink

subframe at the UE assuming NTA=0. The eNB may estimate the uplink timing from the random access preamble transmitted by the UE. The TA command may be derived by the eNB based on the estimation of the difference between the desired UL timing and the actual UL timing. The UE may determine the initial uplink transmission timing relative to the corresponding downlink of the sTAG on which the preamble is transmitted.

**[0120]** The mapping of a serving cell to a TAG may be configured by a serving eNB with RRC signaling. The mechanism for TAG configuration and reconfiguration may be based on RRC signaling. According to various aspects of an embodiment, when an eNB performs an SCell addition configuration, the related TAG configuration may be configured for the SCell. In an example embodiment, an eNB may modify the TAG configuration of an SCell by removing (releasing) the SCell and adding (configuring) a new SCell (with the same physical cell ID and frequency) with an updated TAG ID. The new SCell with the updated TAG ID may initially be inactive subsequent to being assigned the updated TAG ID. The eNB may activate the updated new SCell and start scheduling packets on the activated SCell. In an example implementation, it may not be possible to change the TAG associated with an SCell, but rather, the SCell may need to be removed and a new SCell may need to be added with another TAG. For example, if there is a need to move an SCell from an sTAG to a pTAG, at least one RRC message, (for example, at least one RRC reconfiguration message), may be sent to the UE to reconfigure TAG configurations by releasing the SCell and then configuring the SCell as a part of the pTAG. When an SCell is added/configured without a TAG index, the SCell may be explicitly assigned to the pTAG. The PCell may not change its TA group and may be a member of the pTAG.

**[0121]** The purpose of an RRC connection reconfiguration procedure may be to modify an RRC connection, (for example, to establish, modify and/or release RBs, to perform handover, to setup, modify, and/or release measurements, to add, modify, and/or release SCells). If the received RRC Connection Reconfiguration message includes the sCellToReleaseList, the UE may perform an SCell release. If the received RRC Connection Reconfiguration message includes the sCellToAddModList, the UE may perform SCell additions or modification.

**[0122]** In LTE Release-10 and Release-11 CA, a PUCCH may only be transmitted on the PCell (PSCell) to an eNB. In LTE-Release 12 and earlier, a UE may transmit PUCCH information on one cell (PCell or PSCell) to a given eNB.

**[0123]** As the number of CA capable UEs and also the number of aggregated carriers increase, the number of PUCCHs and also the PUCCH payload size may increase. Accommodating the PUCCH transmissions on the PCell may lead to a high PUCCH load on the PCell. A PUCCH on an SCell may be introduced to offload the PUCCH resource from the PCell. More than one PUCCH may be configured for example, a PUCCH on a PCell and another PUCCH on an SCell. In the example embodiments, one, two or more cells may be configured with PUCCH resources for transmitting CSI/ACK/NACK to a base station. Cells may be grouped into multiple PUCCH groups, and one or more cell within a group may be configured with a PUCCH. In an example configuration, one SCell may belong to one PUCCH group. SCells with a configured PUCCH transmitted to a base station may be called a PUCCH SCell, and a

cell group with a common PUCCH resource transmitted to the same base station may be called a PUCCH group.

**[0124]** In an example embodiment, a MAC entity may have a configurable timer `timeAlignmentTimer` per TAG. The `timeAlignmentTimer` may be used to control how long the MAC entity considers the Serving Cells belonging to the associated TAG to be uplink time aligned. The MAC entity may, when a Timing Advance Command MAC control element is received, apply the Timing Advance Command for the indicated TAG; start or restart the `timeAlignmentTimer` associated with the indicated TAG. The MAC entity may, when a Timing Advance Command is received in a Random Access Response message for a serving cell belonging to a TAG and/or if the Random Access Preamble was not selected by the MAC entity, apply the Timing Advance Command for this TAG and start or restart the `timeAlignmentTimer` associated with this TAG. Otherwise, if the `timeAlignmentTimer` associated with this TAG is not running, the Timing Advance Command for this TAG may be applied and the `timeAlignmentTimer` associated with this TAG started. When the contention resolution is considered not successful, a `timeAlignmentTimer` associated with this TAG may be stopped. Otherwise, the MAC entity may ignore the received Timing Advance Command.

**[0125]** In example embodiments, a timer is running once it is started, until it is stopped or until it expires; otherwise it may not be running. A timer can be started if it is not running or restarted if it is running. For example, a timer may be started or restarted from its initial value.

**[0126]** Example embodiments of the disclosure may enable operation of multi-carrier communications. Other example embodiments may comprise a non-transitory tangible computer readable media comprising instructions executable by one or more processors to cause operation of multi-carrier communications. Yet other example embodiments may comprise an article of manufacture that comprises a non-transitory tangible computer readable machine-accessible medium having instructions encoded thereon for enabling programmable hardware to cause a device (e.g. wireless communicator, UE, base station, etc.) to enable operation of multi-carrier communications. The device may include processors, memory, interfaces, and/or the like. Other example embodiments may comprise communication networks comprising devices such as base stations, wireless devices (or user equipment: UE), servers, switches, antennas, and/or the like.

**[0127]** The amount of data traffic carried over cellular networks is expected to increase for many years to come. The number of users/devices is increasing and each user/device accesses an increasing number and variety of services, e.g. video delivery, large files, images. This may require not only high capacity in the network, but also provisioning very high data rates to meet customers' expectations on interactivity and responsiveness. More spectrum may therefore be needed for cellular operators to meet the increasing demand. Considering user expectations of high data rates along with seamless mobility, it may be beneficial that more spectrum be made available for deploying macro cells as well as small cells for cellular systems.

**[0128]** Striving to meet the market demands, there has been increasing interest from operators in deploying some complementary access utilizing unlicensed spectrum to meet the traffic growth. This is exemplified by the large number of operator-deployed Wi-Fi networks and the 3GPP stan-

dardization of LTE/WLAN interworking solutions. This interest indicates that unlicensed spectrum, when present, may be an effective complement to licensed spectrum for cellular operators to help addressing the traffic explosion in some scenarios, such as hotspot areas. LAA may offer an alternative for operators to make use of unlicensed spectrum while managing one radio network, thus offering new possibilities for optimizing the network's efficiency.

**[0129]** In an example embodiment, Listen-before-talk (clear channel assessment) may be implemented for transmission in an LAA cell. In a listen-before-talk (LBT) procedure, equipment may apply a clear channel assessment (CCA) check before using the channel. For example, the CCA may utilize at least energy detection to determine the presence or absence of other signals on a channel in order to determine if a channel is occupied or clear, respectively. For example, European and Japanese regulations mandate the usage of LBT in the unlicensed bands. Apart from regulatory requirements, carrier sensing via LBT may be one way for fair sharing of the unlicensed spectrum.

**[0130]** In an example embodiment, discontinuous transmission on an unlicensed carrier with limited maximum transmission duration may be enabled. Some of these functions may be supported by one or more signals to be transmitted from the beginning of a discontinuous LAA downlink transmission. Channel reservation may be enabled by the transmission of signals, by an LAA node, after gaining channel access via a successful LBT operation, so that other nodes that receive the transmitted signal with energy above a certain threshold sense the channel to be occupied. Functions that may need to be supported by one or more signals for LAA operation with discontinuous downlink transmission may include one or more of the following: detection of the LAA downlink transmission (including cell identification) by UEs, time & frequency synchronization of UEs, and/or the like.

**[0131]** In an example embodiment, a DL LAA design may employ subframe boundary alignment according to LTE-A carrier aggregation timing relationships across serving cells aggregated by CA. This may not imply that the eNB transmissions can start only at the subframe boundary. LAA may support transmitting PDSCH when not all OFDM symbols are available for transmission in a subframe according to LBT. Delivery of necessary control information for the PDSCH may also be supported.

**[0132]** An LBT procedure may be employed for fair and friendly coexistence of LAA with other operators and technologies operating in an unlicensed spectrum. LBT procedures on a node attempting to transmit on a carrier in an unlicensed spectrum may require the node to perform a clear channel assessment to determine if the channel is free for use. An LBT procedure may involve at least energy detection to determine if the channel is being used. For example, regulatory requirements in some regions, for example, in Europe, may specify an energy detection threshold such that if a node receives energy greater than this threshold, the node assumes that the channel is not free. While nodes may follow such regulatory requirements, a node may optionally use a lower threshold for energy detection than that specified by regulatory requirements. In an example, LAA may employ a mechanism to adaptively change the energy detection threshold. For example, LAA may employ a mechanism to adaptively lower the energy detection threshold from an upper bound. Adaptation mechanism(s) may not preclude

static or semi-static setting of the threshold. In an example a Category 4 LBT mechanism or other type of LBT mechanisms may be implemented.

**[0133]** Various example LBT mechanisms may be implemented. In an example, for some signals, in some implementation scenarios, in some situations, and/or in some frequencies, no LBT procedure may be performed by the transmitting entity. In an example, Category 2 (for example, LBT without random back-off) may be implemented. The duration of time that the channel is sensed to be idle before the transmitting entity transmits may be deterministic. In an example, Category 3 (for example, LBT with random back-off with a contention window of fixed size) may be implemented. The LBT procedure may have the following procedure as one of its components. The transmitting entity may draw a random number  $N$  within a contention window. The size of the contention window may be specified by the minimum and maximum value of  $N$ . The size of the contention window may be fixed. The random number  $N$  may be employed in the LBT procedure to determine the duration of time that the channel is sensed to be idle before the transmitting entity transmits on the channel. In an example, Category 4 (for example, LBT with random back-off with a contention window of variable size) may be implemented. The transmitting entity may draw a random number  $N$  within a contention window. The size of the contention window may be specified by a minimum and maximum value of  $N$ . The transmitting entity may vary the size of the contention window when drawing the random number  $N$ . The random number  $N$  may be employed in the LBT procedure to determine the duration of time that the channel is sensed to be idle before the transmitting entity transmits on the channel.

**[0134]** LAA may employ uplink LBT at the UE. The UL LBT scheme may be different from the DL LBT scheme (for example, by using different LBT mechanisms or parameters), since the LAA UL may be based on scheduled access which affects a UE's channel contention opportunities. Other considerations motivating a different UL LBT scheme include, but are not limited to, multiplexing of multiple UEs in a single subframe.

**[0135]** In an example, a DL transmission burst may be a continuous transmission from a DL transmitting node with no transmission immediately before or after from the same node on the same CC. A UL transmission burst from a UE perspective may be a continuous transmission from a UE with no transmission immediately before or after from the same UE on the same CC. In an example, a UL transmission burst may be defined from a UE perspective. In an example, a UL transmission burst may be defined from an eNB perspective. In an example, in case of an eNB operating DL+UL LAA over the same unlicensed carrier, DL transmission burst(s) and UL transmission burst(s) on LAA may be scheduled in a TDM manner over the same unlicensed carrier. For example, an instant in time may be part of a DL transmission burst or an UL transmission burst.

**[0136]** In an example embodiment, in an unlicensed cell, a downlink burst may be started in a subframe. When an eNB accesses the channel, the eNB may transmit for a duration of one or more subframes. The duration may depend on a maximum configured burst duration in an eNB, the data available for transmission, and/or eNB scheduling algorithm. FIG. 10 shows an example downlink burst in an unlicensed (e.g. licensed assisted access) cell. The maxi-

um configured burst duration in the example embodiment may be configured in the eNB. An eNB may transmit the maximum configured burst duration to a UE employing an RRC configuration message.

**[0137]** The wireless device may receive from a base station at least one message (for example, an RRC) comprising configuration parameters of a plurality of cells. The plurality of cells may comprise at least one license cell and at least one unlicensed (for example, an LAA cell). The configuration parameters of a cell may, for example, comprise configuration parameters for physical channels, (for example, a ePDCCH, PDSCH, PUSCH, PUCCH and/or the like).

**[0138]** An enhanced frame structure type 3 may be applicable to LAA secondary cell operation. LAA cells may employ normal cyclic prefix. In an example, a radio frame may be  $T_f=307200$ .  $T_s=10$  ms long and comprises of 20 slots of length  $T_{slot}=15360 \cdot T_s=0.5$  ms, numbered from 0 to 19. A subframe may be defined as two consecutive slots where subframe  $i$  comprises of slots  $2i$  and  $2i+1$ .

**[0139]** The 10 subframes within a radio frame may be available for downlink transmissions. Downlink transmissions may occupy one or more consecutive subframes, starting anywhere within a subframe and ending with the last subframe either fully occupied or following one of the DwPTS durations in the table in FIG. 11 and downlink transmission in FIG. 12.

**[0140]** In an enhanced frame structure type 3 (equally may be called "frame structure type 3"), a subframe may be used for uplink transmission. An eNB operating LAA SCell(s) may configure and/or activate multiple LAA SCells for downlink and/or uplink transmissions. Example embodiments of the invention describes methods and systems for multi-carrier LBT in uplink and/or downlink of LAA.

**[0141]** As described in the specification, cells may be grouped. Mechanisms described in example embodiments may be applicable to cells in a group of one or more cell groups. For example, the timings related to UL transmissions, reservation signals, downlink signal reception and LBT process may be separately applied to cells of different groups. For example, LBT thresholds of a first cell in a first cell group may be configured (or adjusted) based on other transmissions of a second cell in the same cell group. For example, LBT thresholds of a first cell in a first cell group may be independent or follow a different rule when other transmissions of a second cell of a different group. Some of the example embodiments shown below are illustrated for cells in one cell group. The examples may be applied to multiple groups considering that the mechanisms in one cell group may not change the operations of cells of another cell group or may change (based on a different mechanism) the operations of cells of another cell group. For example, an uplink transmission in a first cell of a first cell group may cause a change in uplink LBT threshold and/or timing in a second cell in the first cell group, may impact the LBT threshold and/or timing differently for a third cell of a second group, or may not impact the LBT threshold and/or timing differently for a third cell of a second group.

**[0142]** The eNB may transmit one or more RRC message to a wireless device including parameters of LAA cells and group parameters. In an example, an RRC message may have grouping information. The RRC message may assign a cell to a cell group. For example, the RRC configuration parameters for a cell may include a group index assigning

the cell to a group. In an example, the RRC message may comprise parameters on threshold and/or timing adjustment of LBT processes of different cells. For example, a first parameter may indicate a first adjustment for LBT of a first cell when other cells in the same group are transmitting. For example, a second parameter may indicate a second adjustment for LBT of a first cell when other cells in a different cell group are transmitting. In an example, an eNB may transmit to a UE an RRC message comprising one or more LBT configuration parameters of an LAA cell. The one or more LBT configuration parameters may comprise an LBT energy detection threshold offset value employed for adjusting an LBT threshold value. The UE may employ the offset value to offset a default maximum energy detection threshold value. The LBT threshold value may be employed by the UE to perform an LBT procedure and determine whether the channel is clear. In an example, the UE may perform an LBT procedure in response to receiving an uplink DCI from the eNB for transmission of one or more transport blocks. The UE may transmit one or more transport blocks when the LBT indicates a clear channel.

**[0143]** Example embodiments describe LBT mechanism, reservation signals, and uplink/downlink transmissions when multiple LAA cells are configured and activated. Example embodiments below are described for cells in a cell group of one or more cell groups.

**[0144]** The eNB may schedule the UE through self-scheduling (e.g., eNB may transmit the uplink grant(s) on the same carrier(s) that is(are) being scheduled) or through cross-carrier scheduling (e.g., eNB may transmit the uplink grant(s) on a licensed scheduling carrier).

**[0145]** Subframe timings shown in the diagrams may be the uplink subframe timing. It is understood that downlink subframe timing may be different due to  $N_{TA}$  adjustments.

**[0146]** An eNB may schedule a UE on  $K$  LAA SCells [SCell<sub>1</sub>, . . . , SCell<sub>K</sub>] at subframe  $n$ . The downlink transmissions on the scheduled LAA SCells may end at different times. For example, the downlink transmissions on SCell <sub>$i$</sub>  may end first and the downlink transmission on SCell <sub>$j$</sub>  may end last on or before subframe  $n$  ( $i \neq j$ ;  $1 \leq i, j \leq K$ ). One or more cells may not have any downlink transmissions in one or more subframes before subframe  $n$ . In addition, there may be downlink transmissions on other LAA SCells that may not be scheduled for uplink transmission at subframe  $n$ . An example is shown in FIG. 13.

**[0147]** Due to hardware limitation, downlink on a LAA SCell may be disrupted by uplink transmission on any or a subset of the  $K$  scheduled LAA SCells. This limitation may be due to leakage of energy from uplink transmission of an LAA carrier on the received downlink signals of other LAA carriers.

**[0148]** Due to the above limitation, UE may start uplink transmission on a LAA SCell after downlink transmissions on all of or a subset of the  $K$  LAA SCells or other LAA SCells that may not be scheduled for uplink transmission end. For example, downlink transmission on all of or a subset of the  $K$  LAA SCells and/or other LAA SCells that have not been scheduled for uplink at subframe  $n$  may need to end before uplink transmission on any of the  $K$  LAA SCells could start at subframe  $n$ . In the example in FIG. 13, uplink transmission on any of the  $K$  scheduled carriers may start at subframe  $n$  after downlink burst on LAA SCell <sub>$j$</sub>  ends. In some other example (not shown here) downlink transmission on the cells may end before subframe  $n$ , and

subframe  $n$  may be available to an uplink transmission (if LBT indicates a clear channel).

**[0149]** In addition, there may be constraints on the starting position(s) of an uplink reservation signal and/or data/control in a subframe. For example, allowed starting symbols for an uplink data/control transmission may be symbols 0 and 7 (slot boundaries). For example, allowed starting symbols for an uplink data/control transmission may be symbols 1 and 7. An eNB may transmit an RRC message comprising parameters indicating the allowed starting symbols for uplink transmissions of data/control in a subframe.

**[0150]** In an example, a UE may be able to transmit an uplink reservation signal on one or more cells to reserve the channel for uplink data/control transmission. In an example embodiment, reservation signal configuration parameters may include allowed starting positions, power, duration, format, RBs, and/or threshold parameters. An RRC message may include one more parameters indicating one or more of the reservation signal parameters.

**[0151]** These constraints (DL transmissions and/or configuration parameters) may limit the starting position of an uplink burst and/or the LBT process for uplink transmissions in a subframe. In one example, partial uplink subframe may start at the slot boundary. In another example, uplink partial subframe may start at one of several positions within a subframe.

**[0152]** A UE may transmit uplink transmission on any of the  $K$  scheduled LAA carriers after UE completes LBT on those carriers.

**[0153]** In an example embodiment, a UE may start LBT on different carriers (on or before subframe  $n$ ) at different times. For example, an uplink LBT on a carrier may start after the downlink data/control transmission on that carrier ends. A UE may continue listening and monitoring the channel status until it transmits on the carrier. An example is shown in FIG. 14.

**[0154]** In an example embodiment, a UE may start an LBT on different carriers (on or before subframe  $n$ ) substantially at the same time. For example, an uplink LBT on carriers may start after the downlink data/control transmission on the carrier's end. A UE may continue listening and monitoring the channel status until it transmits on the carrier (See FIG. 15). The process in FIG. 15 may allow an LBT may start at a later time (e.g., after completion of downlink burst on all of the carriers). In an example and depending on the implemented LBT mechanism, an LBT may indicate a clear channel for less number of carriers compared to option in FIG. 14, for example when LBT duration is a random value.

**[0155]** In an example embodiment, for the scheduled carriers for which uplink data transmission lead to disruption on any of the carriers with ongoing downlink, LBT on a carrier may start after the UE receiving downlink burst ends on any of the carriers with ongoing downlink. An example is shown in FIG. 15.

**[0156]** In an example embodiment, no reservation signal may be transmitted and transmission of uplink data/control signals on different cells may start at the same symbol in a subframe. The transmission may start at a first allowed symbol (e.g., partial or full uplink subframe). For example, the UE may continue the LBT process on the carriers until LBT indicates a clear channel on one or more cells. In an implementation, a UE may continue an LBT for transmission in subframe  $n$  until the  $K$  scheduled cells indicate a clear channel for transmission of a partial or full subframe

in subframe  $n$ . In an implementation, the UE may continue LBT for transmission in subframe  $n$  until the one or more scheduled cells indicate a clear channel for transmission of a partial or full subframe in subframe  $n$  starting from an allowed starting symbol. The allowed starting symbol may be the first allowed starting symbol in a subframe, the last allowed starting symbol in a subframe, the slot boundary, and/or the like. When an LBT for a cell does not indicate a clear channel before the allowed starting symbol, the UE may not transmit uplink data/control signals in subframe  $n$  in that cell.

**[0157]** In an example embodiment, no reservation signal may be transmitted and transmission of uplink data/control signals on different cells may be allowed to start at the same symbol or different symbols in a subframe. The transmission may start at a first allowed symbol (e.g., partial or full uplink subframe). For example, the UE may continue the LBT process on the carriers until an LBT indicates a clear channel on one or more cells. In an implementation, the UE may continue an LBT for transmission in subframe  $n$  until the LBT on the cell indicates a clear channel for transmission of a partial or full subframe in subframe  $n$  starting from an allowed starting symbol. When an LBT for a cell does not indicate a clear channel before the last allowed starting symbol, the UE may not transmit uplink data/control signals in subframe  $n$  in that cell. In this example, the UE may start uplink transmission of data/control in different subframe at different symbols. In an implementation, the LBT timing, process, and/or threshold of a first cell may be updated when an LBT is performed on the first cell and a second cell already started uplink transmission.

**[0158]** In an example embodiment, transmission of a reservation signal may be allowed so that a UE can reserve a channel when an LBT indicates a clear channel and before data/control transmission. Transmission of uplink reservation signals on different cells may start substantially at the same time (e.g., at the same symbol) in a subframe. The transmission may start at a first allowed symbol (e.g., partial or full uplink subframe). For example, the UE may continue the LBT process on the carriers until an LBT indicates a clear channel on one or more cells. Reservation signal configuration parameters may include allowed starting positions, power, duration, format, RBs, and/or threshold parameters. The starting time of reservation signal transmission may depend on reservation signal parameters. In an implementation, a UE may continue an LBT for transmission in subframe  $n$  until the  $K$  scheduled cells indicate a clear channel for transmission of a partial or full subframe in subframe  $n$  starting from an allowed starting symbol. The allowed starting symbol may be the first allowed starting symbol in a subframe, the last allowed starting symbol in a subframe, the slot boundary, and/or the like. When an LBT for a cell does not indicate a clear channel before the allowed starting symbol, the UE may not transmit uplink reservation, and/or data/control signals in subframe  $n$  in that cell. A UE may transmit data/control signal after transmission of a reservation signal in subframe of a cell. A UE may start transmission of data/control from a first allowed symbol after transmission of a reservation signal. Transmission timing of data/control may start at the same symbol in different cells. Transmission

timing of data/control at different cells may start at different starting symbols depending on cell configuration parameters. For example, different cells may have different allowed starting symbol configuration.

**[0159]** In an example embodiment, transmission of a reservation signal may be allowed so that a UE can reserve a channel when LBT indicates a clear channel and before data/control transmission. Transmission of uplink reservation signals on different cells may be allowed to start at the same time (e.g., at the same symbol, at the same time position) or at different times in a subframe. The transmission may start at a first allowed symbol (e.g., partial or full uplink subframe). For example, the UE may continue the LBT process on the carriers until the LBT indicates a clear channel on one or more cells. In an implementation, the UE may continue an LBT for transmission in subframe  $n$  until an LBT on the cell indicates a clear channel for transmission of a partial or full subframe in subframe  $n$  starting from an allowed starting-symbol/starting-time. Reservation signal configuration parameters may include allowed starting time positions, power, duration, format, RBs, and/or threshold parameters. The starting time of reservation signal transmission may depend on reservation signal parameters. When an LBT for a cell does not indicate a clear channel before the last allowed starting symbol, the UE may not transmit uplink reservation and/or data/control signals in subframe  $n$  in that cell. In this example, the UE may start uplink transmission of reservation signals in different subframes at different times (e.g. different symbols). In an implementation, the LBT timing, process, and/or threshold of a first cell may be updated when LBT is performed on the first cell and a second cell already started uplink transmission. A UE may transmit data/control signal after transmission of a reservation signal in subframe of a cell. A UE may start transmission of data/control from a first allowed symbol after transmission of a reservation signal. Transmission timing of data/control may start at the same symbol/time in different cells. Transmission timing of data/control at different cells may start at different starting symbols/times depending on cell configuration parameters. For example, different cells may have different allowed starting symbol and/or time configuration.

**[0160]** In an example embodiment, a UE may start transmission on one or more SCells that have completed an LBT at a first time within subframe  $n$ . After uplink transmission on carriers that have completed an LBT, the LBT may no longer indicate a clear channel for the other scheduled carriers due to energy leakage from ongoing uplink transmissions, and if the LBT threshold remain the same. UE may stop an LBT and may no longer transmit uplink signals in a subframe of a cell when uplink transmission on another cell has already started. This may imply that transmission on different cells may start at the same time (e.g. the same symbol). A UE may not transmit uplink signals on one or more cells when an LBT does not indicate a clear channel.

**[0161]** In an example embodiment, a UE may continue LBT on a cell when uplink transmission on another cell already started. A UE may employ an updated LBT process when transmission on another cell already started. The updated LBT process may include an updated detection mechanism, timing and threshold. For example, the updated LBT process may include some signal/interference cancellation mechanism taking into account the signals already being transmitted on other cells. The UE may know the



signal, its power, wave shaping, etc. and may be able to consider this in its LBT process. Signal leakage of one or more cells may be cancelled to some degree. A UE may use a higher energy detection threshold for an LBT on scheduled carriers when another carrier is already transmitting. For example, if UE transmits on L out of K scheduled LAA SCells, the UE may continue an LBT on other scheduled carriers and adjust as much as  $L \times \Delta_{uplink}$  dBm the energy detection threshold for LBT on the other carriers where  $\Delta_{uplink}$  is energy detection threshold offset when uplink transmission on a single adjacent carrier is ongoing. In an example, the UE may change one or more LBT timing parameters or counter values for an updated LBT process. An RRC message may include one or more parameters indicating parameters of the updated LBT process. For example, one or more parameters may indicate a threshold adjustment parameter when another cell is transmitting data/control signals. One or more parameters may indicate a threshold adjustment parameter when another cell is transmitting reservation signals. Adjustment factors may depend on the number already transmitting cells. One or more parameters may indicate one or more timer values and/or one or more counter values of the updated LBT process. An RRC parameter  $\Delta_{uplink}$  may be configurable by an eNB and through RRC configuration.

**[0162]** In an example embodiment, a UE may receive an uplink grant for transmission of uplink signals in subframe  $n+k$  ( $k>0$ ) for a cell when the UE has already started transmission in prior subframes on another cell. The UE may employ the updated LBT process to start LBT for transmission in subframe  $n+k$ .

**[0163]** In a multi-carrier LBT process, the UE may start an LBT earlier on a lead LAA cell compared with other LAA cells. In an example, a UE may select (e.g. uniformly randomly) a cell from a plurality of cells in a group as a lead cell. A UE may start a first LBT process on the lead cell earlier, and after the first LBT process on the lead cell meets certain criteria, then the UE may start a second LBT process on other cells. The criteria for example, may be based on detecting no interference/signal during a one or more time durations, and/or a counter reaching certain value. The first LBT process may be different than the second LBT process. For example, the first LBT process may require a longer LBT period than the second LBT process. The second LBT process may include less number monitoring time intervals and/or shorter monitoring time intervals. The first LBT process may include a different threshold values compared with the second LBT process (for example a lower threshold). An RRC message may include one or more configuration parameters of the first LBT and/or second LBT.

**[0164]** In an example embodiment, the lead cell may be selected by UE according to a predefined rule. For example, the lead cell may be randomly selected (e.g. uniformly randomly), or be the cell with the lowest cell index. In an example, the eNB may indicate the lead cell to the UE along with the physical layer grant or other physical layer signals. The eNB may indicate the lead cell in a group via RRC message.

**[0165]** An eNB may access multiple channels on which LAA Scell(s) transmission(s) are performed. As described in the specification, cells may be grouped. Mechanisms described in example embodiments may be applicable to cells in a group of one or more cell groups. For example, the timings related to DL transmissions, reservation signals, and

LBT process may be separately applied to cells of different groups. For example, LBT thresholds of a first cell in a first cell group may be adjusted based on other transmissions of a second cell in the same cell group. For example, LBT thresholds of a first cell in a first cell group may be independent or follow a different rule when other transmissions of a second cell of a different group. Some of the example embodiments shown below are illustrated for cells in one cell group. The examples may be applied to multiple groups considering that the mechanisms in one cell group may not change the operations of cells of another cell group or may change (based on a different mechanism) the operations of cells of another cell group. For example, a downlink transmission in a first cell of a first cell group may cause a change in downlink LBT threshold and/or timing in a second cell in the first cell group, may impact the LBT threshold and/or timing differently for a third cell of a second group, or may not impact the LBT threshold and/or timing differently for a third cell of a second group.

**[0166]** Two types of multi-carrier downlink channel access using one of the Type A or Type B procedures described below may be used.

**[0167]** Based on type A procedure, the eNB may perform channel access on each channel  $c_i \in C$ , where C is a set of channels (cells) in a cell group on which the eNB intends to transmit, and  $i=0, 1, \dots, q-1$ , and q is the number of channels in a cell group on which the eNB intends to transmit. Based on type A procedure, the channel access on each channel  $c_i \in C$  may be based on the following procedure. The eNB may transmit a transmission including PDSCH on a channel after sensing the channel to be idle during the slot durations of a defer duration  $T_d$ ; and after the counter N is zero in Action 4 below. For example, the counter N may be adjusted by sensing the channel for additional slot duration(s) according to the Actions below:

**[0168]** 1) set  $N=N_{init}$  where  $N_{init}$  is a random number uniformly distributed between 0 and  $CW_p$ ;  $CW_p$  is the contention window size for priority class p.

**[0169]** 2) if  $N>0$  and the eNB chooses to decrement the counter, set  $N=N-1$ .

**[0170]** 3) sense the channel for an additional slot duration, and if the additional slot duration is idle, go to Action 4; else, go to Action 5.

**[0171]** 4) if  $N=0$ , stop; else, go to Action 2.

**[0172]** 5) sense the channel during the slot durations of an additional defer duration  $T_d$ .

**[0173]** 6) if the channel is sensed to be idle during the slot durations of the additional defer duration  $T_d$ , go to Action 2; else, go to Action 5.

**[0174]** Based on type A multi-carrier channel access, the counter N may be determined independently for each channel  $c_i$  and may be denoted as N. Alternatively, N may be determined for channel  $c_j \in C$  where  $c_j$  is the channel that has the largest  $CW_p$  value and for each channel  $c_i$ , we may have  $N_{c_i} = N_{c_j}$ .

**[0175]** The channels may be grouped in multiple cell groups. The mechanisms described in the embodiments may be separately applicable to cells in a cell group of one or more cell groups. C is the set of cells in a cell group wherein eNB transmits to q cells in C. In an example, a second cell group may include a different set of cells D, in which eNB intends to transmit on p cells.

**[0176]** Based on type B multi-carrier channel access, a channel  $c_j \in C$  may be selected by the eNB as follows: the

eNB may select  $c_j$  by uniformly randomly choosing  $c_j$  from  $C$  before each transmission on multiple channels  $c_i \in C$ , or the eNB may select  $c_j$  no more frequently than once every 1 second, where  $C$  is a set of channels on which the eNB intends to transmit,  $i=0, 1, \dots, q-1$ , and  $q$  is the number of channels on which the eNB intends to transmit.

**[0177]** To transmit on channel  $c_j$ , the eNB may perform channel access on channel  $c_j$  according to the procedures described above based on Actions 1-6.

**[0178]** To transmit on channel  $c_i \neq c_j$ ,  $c_i \in C$ , for each channel  $c_i$ , the eNB may sense the channel  $c_i$  for at least a sensing interval  $T_{mc}=25$  us immediately before the transmitting on channel  $c_j$ , and the eNB may transmit on channel  $c_i$  immediately after sensing the channel  $c_i$ , if the power detected by the eNB on channel  $c_i$  during  $T_{mc}$  is less than energy detection threshold.

**[0179]** Based on type B multi-carrier channel access procedure, LBT on multiple LAA carriers may complete at the same time and eNB may transmit data on all of the LAA carriers at the same time. Based on type A multi-carrier channel access procedure, LBT on multiple LAA carriers may not complete at the same time and therefore transmission on different LAA carriers may not start at the same time.

**[0180]** When LBT on multiple LAA carriers complete at different times and downlink transmission on different LAA carriers do not start at the same time, it is possible that downlink transmission on one or more LAA carriers lead to inaccurate LBT on the other carriers.

**[0181]** In one example embodiment, eNB may apply self-deferral on carriers that complete LBT earlier so that the transmission time on different carriers are aligned.

**[0182]** The example embodiments may be implemented for each cell group and access process may be independently managed for each cell group.

**[0183]** In one example embodiment, eNB may transmit on a carrier after LBT on the carrier indicates a clear channel. The eNB may continue an LBT on a cell, using an updated LBT process, when downlink transmission on another cell already started. The updated LBT process may include an updated detection mechanism, timing and threshold. For example, the updated LBT process may include some signal/interference cancellation mechanism taking into account the signals already being transmitted on other cells. The eNB knows the signal, its power, wave shaping, etc. and may be able to consider this in its LBT process. Signal leakage of one or more cells may be cancelled to some degree. An eNB may use higher energy detection threshold for LBT on a carrier when another carrier is already transmitting. For example, for other carrier(s) for which LBT is still ongoing, the eNB may consider adding an energy detection threshold offset  $\Delta_{downlink}$  for any carrier with ongoing transmission that start earlier and lead to leaked energy to the other carrier(s) for which LBT is still ongoing.

**[0184]** An example embodiment is shown in FIG. 16 where the LAA carriers 1 to N are sorted according to the times that their LBT opens. The energy detection (ED) threshold used for an LBT on any carrier may be dynamically offset as much as  $L \times \Delta_{downlink}$  if  $L$  downlink transmission on  $L$  adjacent carriers start earlier. In this example,  $X$  is the energy detection threshold when no ongoing downlink transmission on adjacent carriers that lead to energy leakage takes place.

**[0185]** An example embodiment is shown in FIG. 17 where a UE receives one or more RRC messages comprising

one or more LBT configuration parameters for one or more LAA cell. In an example, the one or more LBT configuration parameters may comprise one or more first energy detection thresholds. For example, the first energy detection threshold may be considered as a maximum energy detection threshold. The UE may employ an LBT threshold lower (or equal) than the maximum energy detection threshold to perform an LBT procedure. In an example, the one or more LBT configuration parameters may comprise one or more energy detection threshold offset values. In an example, the energy detection threshold offset value may indicate an offset to a default maximum energy detection threshold value.

**[0186]** The UE may receive one or more DCI comprising uplink grant parameters for one or more uplink transmission on an LAA cell. The one or more DCI may be transmitted using PDCCH and/or ePDCCH. In an example, a DCI may be received in a first subframe and the uplink grant may be for  $k$  subframes after the first subframe. The UE may attempt to transmit one or more uplink signals employing the parameters in the one or more DCI. The UE may generate one or more transport blocks employing the parameters in the one or more DCI. The one or more uplink signals may comprise one or more PUSCCH and/or one or more PUCCH and/or one or more SRS and/or one or more random access preambles. The UE may determine an energy detection threshold employing the one or more LBT configuration parameters. In an example, the UE may determine the energy detection threshold to be lower than or equal to the first energy detection threshold. The UE may perform an LBT procedure employing the energy detection threshold. The UE may perform the one or more uplink transmission if the LBT procedure indicates a clear channel. In an example, a transmission may start at one of a plurality of pre-configured starting positions. In an example, the base station may indicate the one of a plurality of starting positions for the transmitting the one or more TBs. In an example, the LBT procedure may comprise sensing the LAA cell and comparing a detected power with the energy detection threshold.

**[0187]** In an example, the one or more RRC messages may comprise one or more LBT configuration parameters for each of a plurality of LAA cells. The UE may receive uplink grants for uplink transmissions on the plurality of LAA cells. The uplink transmissions may be configured to have the same starting position. The UE may determine an energy detection threshold for each of the plurality of LAA cells based, at least in part, on the corresponding one or more LBT parameters. The UE may select a first LAA cell uniformly randomly from the plurality of LAA cells and perform a first LBT procedure for the first LAA cell employing a long monitoring period. The UE may perform a second LBT procedure for a second LAA cell in the plurality of LAA cells employing a short monitoring period. If the first LBT procedure indicates a clear channel, the UE may transmit to the base station, one or more first transport blocks (TBs) on the first LAA cell. The UE may transmit, to the base station, one or more second TBs on the second LAA cell when the first LBT procedure and the second LBT procedure indicate a clear channel.

**[0188]** According to various embodiments, a device such as, for example, a wireless device, a base station and/or the like, may comprise one or more processors and memory. The memory may store instructions that, when executed by the one or more processors, cause the device to perform a series

of actions. Embodiments of example actions are illustrated in the accompanying figures and specification.

**[0189]** FIG. 18 is an example flow diagram as per an aspect of an embodiment of the present disclosure. At **1810**, a wireless device may receive from a base station, one or more radio resource control (RRC) messages. The one or more RRC messages may comprise configuration parameters for a licensed assisted access (LAA) cell. The one or more RRC messages may comprise listen before talk (LBT) configuration parameters for the LAA cell. The LBT configuration parameters may comprise a first energy detection threshold value. At **1820**, the wireless device may receive a downlink control information (DCI) indicating an uplink grant for the LAA cell. At **1830**, the wireless device may generate one or more transport blocks (TBs) employing the uplink grant. At **1840**, the wireless device may perform an LBT procedure on the LAA cell. The LBT procedure may employ an energy detection threshold lower than or equal to the first energy detection threshold value. At **1850**, the wireless device may transmit the one or more TBs on the LAA cell if the LBT procedure indicates a clear channel.

**[0190]** The LAA cell may operate according to, for example, frame structure Type 3. The DCI may be received on, for example, the LAA cell. The DCI is received on, for example, a licensed cell. The DCI may be transmitted using, for example, a physical downlink control channel (PDCCH) or an enhanced physical downlink control channel (ePDCCH). The DCI may, for example, be received in a first subframe and the uplink grant may be for k subframes after the first subframe. The transmitting may start, for example, at one of a plurality of pre-configured starting positions. The base station may indicate, for example, one of a plurality of starting positions for the transmitting the one or more TBs. According to an embodiment, the LBT procedure may comprise sensing the LAA cell and comparing a detected power with the energy detection threshold.

**[0191]** FIG. 19 is an example flow diagram as per an aspect of an embodiment of the present disclosure. At **1910**, a wireless device may receive from a base station, one or more radio resource control (RRC) messages. The one or more RRC messages may comprise configuration parameters for a licensed assisted access (LAA) cell. The one or more RRC messages may comprise listen before talk (LBT) configuration parameters for the LAA cell. The LBT configuration parameters may comprise a first energy detection threshold offset value. At **1920**, the wireless device may receive a physical downlink control channel (PDCCH) indicating an uplink grant for the LAA cell. One or more transport blocks (TBs) using the uplink grant may be generated at **1930**. At **1940**, the wireless device may determine an energy detection threshold for the LAA cell based, at least in part, on the energy detection threshold offset value. At **1950**, the wireless device may perform an LBT procedure on the LAA cell employing the energy detection threshold. At **1960**, the wireless device may transmit the one or more TBs on the LAA cell if the LBT procedure indicates a clear channel.

**[0192]** According to an embodiment, the determining the energy detection threshold may further comprise adjusting the energy detection threshold by the threshold offset value. The base station may indicate, for example, one of a plurality of starting positions for the transmitting the one or more TBs. The transmitting may at, for example, one of a plurality of pre-configured starting positions. The LBT pro-

cedure may comprise sensing the LAA cell and comparing a detected power with the energy detection threshold.

**[0193]** FIG. 20 is an example flow diagram as per an aspect of an embodiment of the present disclosure. At **2010**, a wireless device may receive from a base station, one or more radio resource control (RRC) messages. The one or more RRC messages may comprise configuration parameters for a licensed assisted access (LAA) cell. The one or more RRC messages may comprise listen before talk (LBT) configuration parameters for the LAA cell. The LBT configuration parameters may comprise a first parameter. At **2020**, the wireless device may receive a physical downlink control channel (PDCCH) indicating an uplink grant for the LAA cell. One or more transport blocks (TBs) using the uplink grant may be generated at **2030**. At **2040**, the wireless device may determine an energy detection threshold for the LAA cell based, at least in part, on the first parameter. At **2050**, the wireless device may perform an LBT procedure on the LAA cell employing the energy detection threshold. At **2060**, the wireless device may transmit the one or more TBs on the LAA cell if the LBT procedure indicates a clear channel.

**[0194]** FIG. 21 is an example flow diagram as per an aspect of an embodiment of the present disclosure. At **2110**, a wireless device may receive from a base station, one or more messages. The one or more messages may comprise a corresponding listen before talk (LBT) parameter for each of a plurality of licensed assisted access (LAA) cells. At **2120**, the wireless device may receive uplink grants for uplink transmissions on the plurality of LAA cells. The uplink transmissions may be configured to have a same starting position. At **2130**, the wireless device may determine an energy detection threshold for each of the plurality of LAA cells based, at least in part, on the corresponding LBT parameter. At **2140**, the wireless device may select a first LAA cell uniformly randomly from the plurality of LAA cells. At **2150**, the wireless device may perform a first LBT procedure for the first LAA cell employing a long monitoring period. At **2160**, the wireless device may perform a second LBT procedure for a second LAA cell in the plurality of LAA cells employing a short monitoring period. At **2170**, the wireless device may transmit to the base station, one or more first transport blocks (TBs) on the first LAA cell if the first LBT procedure indicates a clear channel. At **2180**, the wireless device may transmit to the base station, one or more second TBs on the second LAA cell when the first LBT procedure and the second LBT procedure indicate a clear channel.

**[0195]** The plurality of LAA cells may operate according to, for example, frame structure Type 3. At least one of the uplink grants may be, for example, for one of the plurality of LAA cells. At least one of the uplink grants may be received, for example, on at least one licensed cell. Each of the uplink grants may be transmitted using, for example, a physical downlink control channel (PDCCH) or an enhanced physical downlink control channel (ePDCCH). Each of the uplink grants may be, for example: received in a first subframe; and for k subframes after the first subframe. The transmitting the one or more first TBs and the one or more second TBs may start at, for example, one of a plurality of pre-configured starting positions. The first LBT procedure may comprise, for example, sensing a corresponding LAA cell; and comparing a detected power with a corresponding energy detection threshold. The corresponding LBT param-

eter may indicate, for example, an energy detection threshold offset value. The corresponding LBT parameter may indicate, for example, a first energy detection threshold value.

[0196] FIG. 22 is an example flow diagram as per an aspect of an embodiment of the present disclosure. At 2210, a wireless device may receive one or more radio resource control (RRC) messages comprising configuration parameters for a plurality of LAA cells. The configuration parameters may comprise a corresponding listen before talk (LBT) parameter for each of the plurality of LAA cells. At 2220, the wireless device may receive an uplink grant for uplink transmissions on a first LAA cell. At 2230, the wireless device may determine an energy detection threshold for the first LAA cell based, at least in part, on a corresponding LBT parameter and a second parameter. The second parameter may be determined, at least in part, based on whether the wireless device transmits uplink signals on a second LAA cell during an LBT procedure. At 2240, the wireless device may perform, on a first cell, the LBT procedure employing the energy detection threshold. At 2250, the wireless device may transmit on the first LAA cell if the LBT procedure indicates a clear channel.

[0197] In this specification, “a” and “an” and similar phrases are to be interpreted as “at least one” and “one or more.” In this specification, the term “may” is to be interpreted as “may, for example.” In other words, the term “may” is indicative that the phrase following the term “may” is an example of one of a multitude of suitable possibilities that may, or may not, be employed to one or more of the various embodiments. If A and B are sets and every element of A is also an element of B, A is called a subset of B. In this specification, only non-empty sets and subsets are considered. For example, possible subsets of  $B = \{\text{cell1}, \text{cell2}\}$  are:  $\{\text{cell1}\}$ ,  $\{\text{cell2}\}$ , and  $\{\text{cell1}, \text{cell2}\}$ .

[0198] In this specification, parameters (Information elements: IEs) may comprise one or more objects, and each of those objects may comprise one or more other objects. For example, if parameter (IE) N comprises parameter (IE) M, and parameter (IE) M comprises parameter (IE) K, and parameter (IE) K comprises parameter (information element) J, then, for example, N comprises K, and N comprises J. In an example embodiment, when one or more messages comprise a plurality of parameters, it implies that a parameter in the plurality of parameters is in at least one of the one or more messages, but does not have to be in each of the one or more messages.

[0199] Many of the elements described in the disclosed embodiments may be implemented as modules. A module is defined here as an isolatable element that performs a defined function and has a defined interface to other elements. The modules described in this disclosure may be implemented in hardware, software in combination with hardware, firmware, wetware (i.e hardware with a biological element) or a combination thereof, all of which are behaviorally equivalent. For example, modules may be implemented as a software routine written in a computer language configured to be executed by a hardware machine (such as C, C++, Fortran, Java, Basic, Matlab or the like) or a modeling/simulation program such as Simulink, Stateflow, GNU Octave, or LabVIEWMathScript. Additionally, it may be possible to implement modules using physical hardware that incorporates discrete or programmable analog, digital and/or quantum hardware. Examples of programmable hardware

comprise: computers, microcontrollers, microprocessors, application-specific integrated circuits (ASICs); field programmable gate arrays (FPGAs); and complex programmable logic devices (CPLDs). Computers, microcontrollers and microprocessors are programmed using languages such as assembly, C, C++ or the like. FPGAs, ASICs and CPLDs are often programmed using hardware description languages (HDL) such as VHSIC hardware description language (VHDL) or Verilog that configure connections between internal hardware modules with lesser functionality on a programmable device. Finally, it needs to be emphasized that the above mentioned technologies are often used in combination to achieve the result of a functional module.

[0200] The disclosure of this patent document incorporates material which is subject to copyright protection. The copyright owner has no objection to the facsimile reproduction by anyone of the patent document or the patent disclosure, as it appears in the Patent and Trademark Office patent file or records, for the limited purposes required by law, but otherwise reserves all copyright rights whatsoever.

[0201] While various embodiments have been described above, it should be understood that they have been presented by way of example, and not limitation. It will be apparent to persons skilled in the relevant art(s) that various changes in form and detail can be made therein without departing from the spirit and scope. In fact, after reading the above description, it will be apparent to one skilled in the relevant art(s) how to implement alternative embodiments. Thus, the present embodiments should not be limited by any of the above described exemplary embodiments. In particular, it should be noted that, for example purposes, the above explanation has focused on the example(s) using FDD communication systems. However, one skilled in the art will recognize that embodiments of the disclosure may also be implemented in a system comprising one or more TDD cells (e.g. frame structure 2 and/or frame structure 3-licensed assisted access). The disclosed methods and systems may be implemented in wireless or wireline systems. The features of various embodiments presented in this disclosure may be combined. One or many features (method or system) of one embodiment may be implemented in other embodiments. Only a limited number of example combinations are shown to indicate to one skilled in the art the possibility of features that may be combined in various embodiments to create enhanced transmission and reception systems and methods.

[0202] In addition, it should be understood that any figures which highlight the functionality and advantages, are presented for example purposes only. The disclosed architecture is sufficiently flexible and configurable, such that it may be utilized in ways other than that shown. For example, the actions listed in any flowchart may be re-ordered or only optionally used in some embodiments.

[0203] Further, the purpose of the Abstract of the Disclosure is to enable the U.S. Patent and Trademark Office and the public generally, and especially the scientists, engineers and practitioners in the art who are not familiar with patent or legal terms or phraseology, to determine quickly from a cursory inspection the nature and essence of the technical disclosure of the application. The Abstract of the Disclosure is not intended to be limiting as to the scope in any way.

[0204] Finally, it is the applicant’s intent that only claims that include the express language “means for” or “step for” be interpreted under 35 U.S.C. 112. Claims that do not

expressly include the phrase “means for” or “step for” are not to be interpreted under 35 U.S.C. 112.

What is claimed is:

- 1. A method comprising:
  - receiving, by a wireless device from a base station, one or more messages comprising a corresponding listen before talk (LBT) parameter for each of a plurality of licensed assisted access (LAA) cells;
  - receiving, by the wireless device, uplink grants for uplink transmissions on the plurality of LAA cells, the uplink transmissions configured to have a same starting position;
  - determining, by the wireless device, an energy detection threshold for each of the plurality of LAA cells based, at least in part, on the corresponding LBT parameter;
  - selecting, by the wireless device, a first LAA cell uniformly randomly from the plurality of LAA cells;
  - performing, by the wireless device, a first LBT procedure for the first LAA cell employing a long monitoring period;
  - performing, by the wireless device, a second LBT procedure for a second LAA cell in the plurality of LAA cells employing a short monitoring period;
  - transmitting, to the base station, one or more first transport blocks (TBs) on the first LAA cell if the first LBT procedure indicates a clear channel; and
  - transmitting, to the base station, one or more second TBs on the second LAA cell when the first LBT procedure and the second LBT procedure indicates a clear channel.
- 2. The method of claim 1, wherein the plurality of LAA cells operate according to frame structure Type 3.
- 3. The method of claim 1, wherein at least one of the uplink grants is for one of the plurality of LAA cells.
- 4. The method of claim 1, wherein at least one of the uplink grants is received on at least one licensed cell.
- 5. The method of claim 1, wherein each of the uplink grants is transmitted using a physical downlink control channel (PDCCH) or an enhanced physical downlink control channel (ePDCCH).
- 6. The method of claim 1, wherein each of the uplink grants:
  - is received in a first subframe; and
  - is for k subframes after the first subframe.
- 7. The method of claim 1, wherein the transmitting the one or more first TBs and the one or more second TBs start at one of a plurality of pre-configured starting positions.
- 8. The method of claim 1, wherein the first LBT procedure comprises:
  - sensing a corresponding LAA cell; and
  - comparing a detected power with a corresponding energy detection threshold.
- 9. The method of claim 1, wherein the corresponding LBT parameter indicates an energy detection threshold offset value.
- 10. The method of claim 1, wherein the corresponding LBT parameter indicates a first energy detection threshold value.

- 11. A wireless device comprising:
  - one or more processors; and
  - memory storing instructions that, when executed by the one or more processors, cause the wireless device to:
    - receive, from a base station, one or more messages comprising a corresponding listen before talk (LBT) parameter for each of a plurality of licensed assisted access (LAA) cells;
    - receive uplink grants for uplink transmissions on the plurality of LAA cells, the uplink transmissions configured to have a same starting position;
    - determine an energy detection threshold for each of the plurality of LAA cells based, at least in part, on the corresponding LBT parameter;
    - select a first LAA cell uniformly randomly from the plurality of LAA cells;
    - perform a first LBT procedure for the first LAA cell employing a long monitoring period;
    - perform a second LBT procedure for a second LAA cell in the plurality of LAA cells employing a short monitoring period;
    - transmit, to the base station, one or more first transport blocks (TBs) on the first LAA cell if the first LBT procedure indicates a clear channel; and
    - transmit, to the base station, one or more second TBs on the second LAA cell when the first LBT procedure and the second LBT procedure indicates a clear channel.
- 12. The wireless device of claim 10, wherein the plurality of LAA cells operate according to frame structure Type 3.
- 13. The wireless device of claim 10, wherein at least one of the uplink grants is for one of the plurality of LAA cells.
- 14. The wireless device of claim 10, wherein at least one of the uplink grants is received on at least one licensed cell.
- 15. The wireless device of claim 10, wherein each of the uplink grants is transmitted using a physical downlink control channel (PDCCH) or an enhanced physical downlink control channel (ePDCCH).
- 16. The wireless device of claim 10, wherein each of the uplink grants:
  - is received in a first subframe; and
  - is for k subframes after the first subframe.
- 17. The wireless device of claim 10, wherein the transmitting the one or more first TBs and the one or more second TBs start at one of a plurality of pre-configured starting positions.
- 18. The wireless device of claim 10, wherein the instruction to perform the first LBT procedure comprises instructions causing the wireless device to:
  - sense a corresponding LAA cell; and
  - compare a detected power with a corresponding energy detection threshold.
- 19. The wireless device of claim 10, wherein the corresponding LBT parameter indicates an energy detection threshold offset value.
- 20. The wireless device of claim 10, wherein the corresponding LBT parameter indicates a first energy detection threshold value.

\* \* \* \* \*