



(19) **United States**

(12) **Patent Application Publication**
Dinan

(10) **Pub. No.: US 2017/0325225 A1**

(43) **Pub. Date: Nov. 9, 2017**

(54) **UPLINK SIGNAL STARTING POSITION IN A WIRELESS DEVICE AND WIRELESS NETWORK**

H04W 72/12 (2009.01)
H04W 74/08 (2009.01)
H04W 16/14 (2009.01)

(71) Applicant: **Ofinno Technologies, LLC**, Herndon, VA (US)

(52) **U.S. Cl.**
CPC ... *H04W 72/0446* (2013.01); *H04W 74/0816* (2013.01); *H04W 16/14* (2013.01); *H04W 72/1268* (2013.01); *H04W 72/1289* (2013.01)

(72) Inventor: **Esmael Hejazi Dinan**, Herndon, VA (US)

(57) **ABSTRACT**

(73) Assignee: **Ofinno Technologies, LLC**, Herndon, VA (US)

A wireless device receives one or more messages comprising configuration parameters of a licensed assisted access (LAA) cell. The wireless device receives a downlink control information (DCI) for the LAA cell. The DCI may comprise a first field and a second field. The first field indicates uplink resources for an uplink subframe of the LAA cell. The second field indicates a first starting position in a plurality of starting positions in the uplink subframe. The first starting position in the uplink subframe is determined, at least, based on a sum of twenty-five micro-seconds plus a timing advance value. The wireless device constructs one or more transport blocks employing the DCI. The wireless device transmits the one or more transport blocks in the uplink resources starting from the first starting position of the uplink subframe.

(21) Appl. No.: **15/589,411**

(22) Filed: **May 8, 2017**

Related U.S. Application Data

(60) Provisional application No. 62/332,510, filed on May 6, 2016.

Publication Classification

(51) **Int. Cl.**
H04W 72/04 (2009.01)
H04W 72/12 (2009.01)

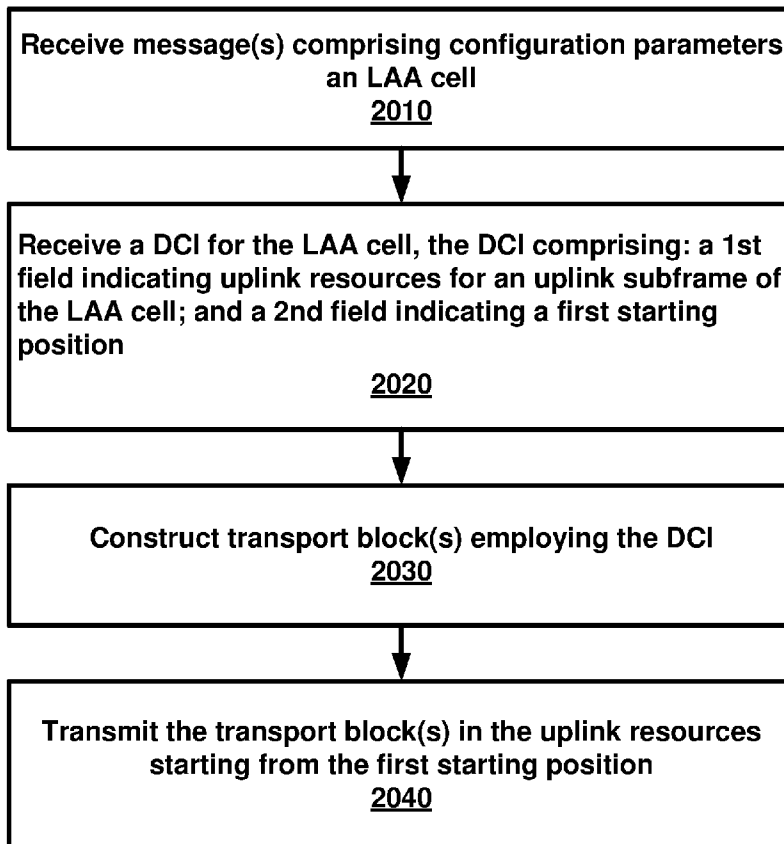

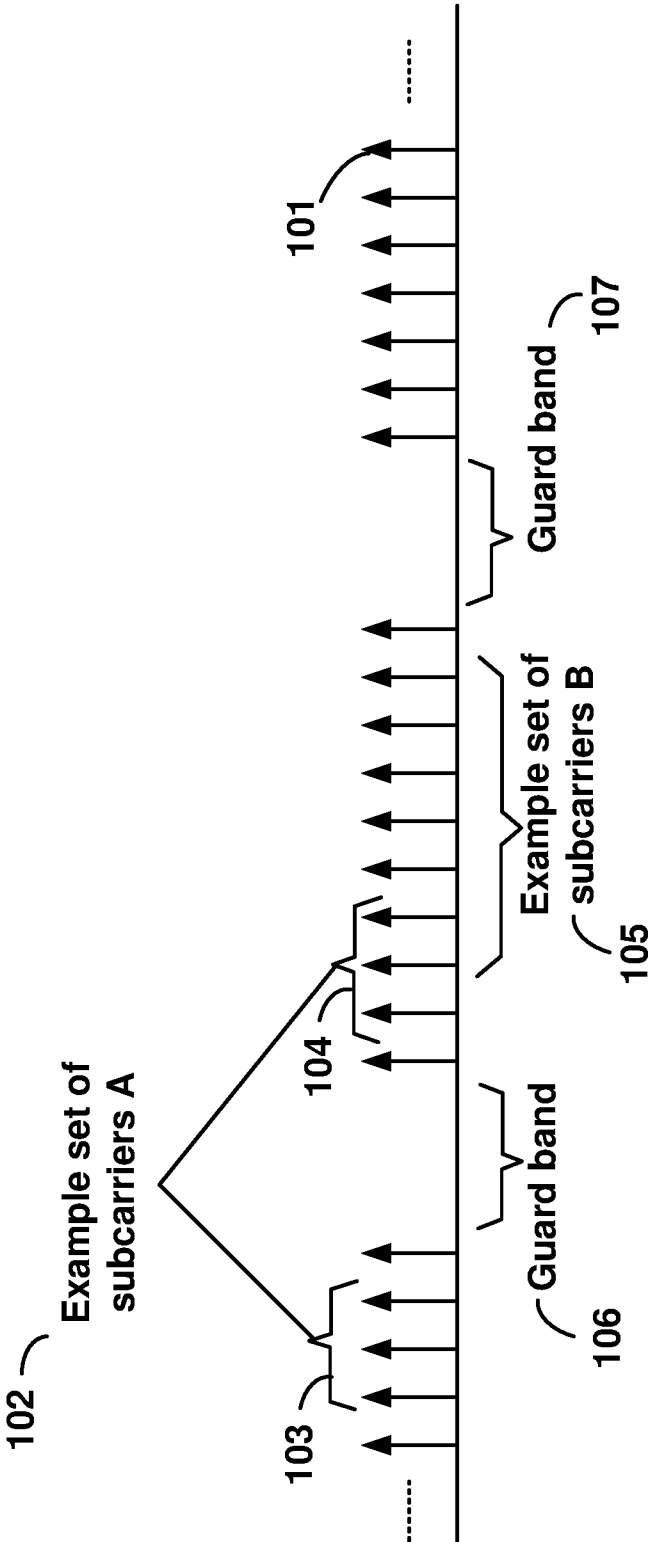

FIG. 1

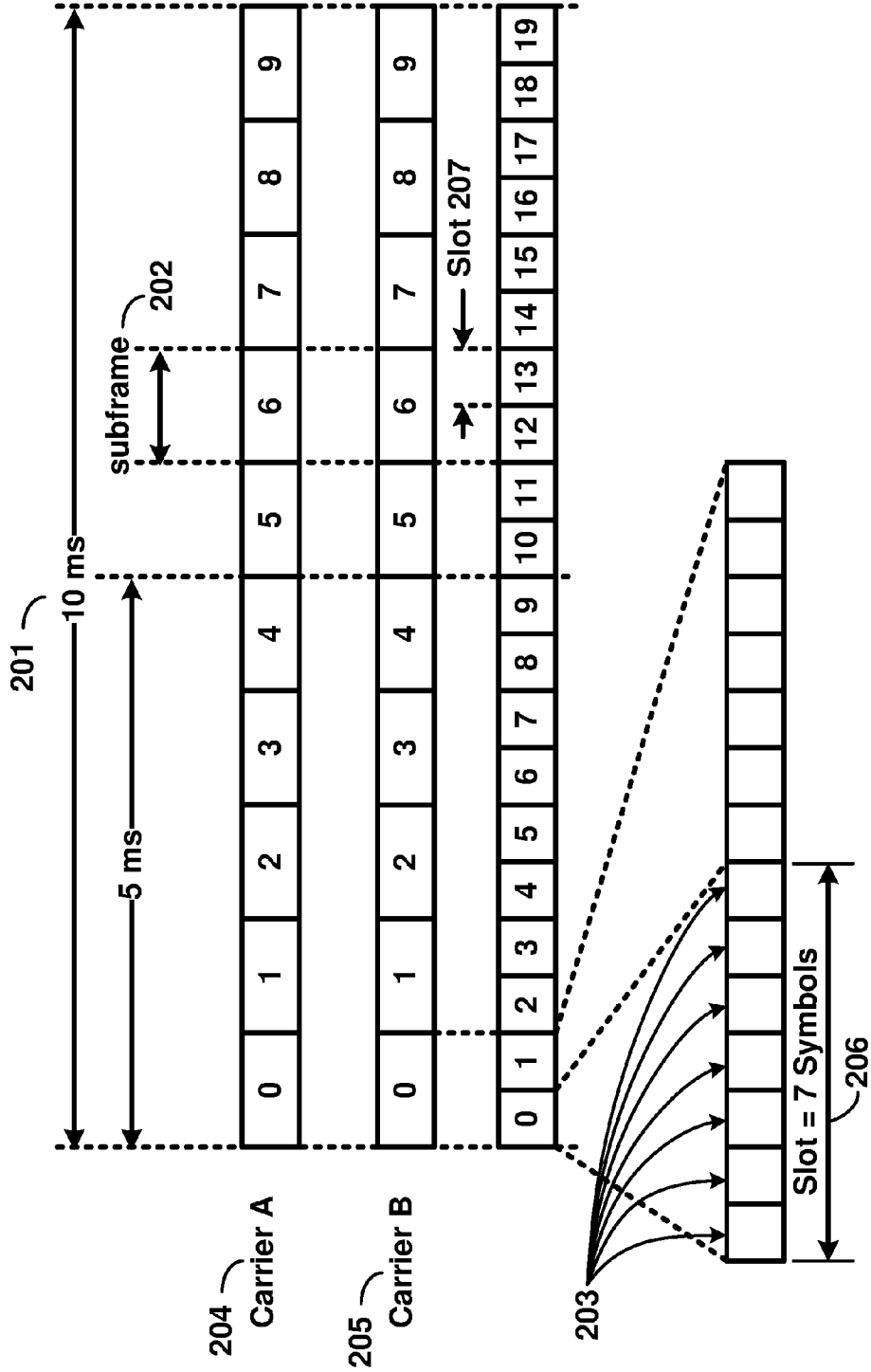

FIG. 2

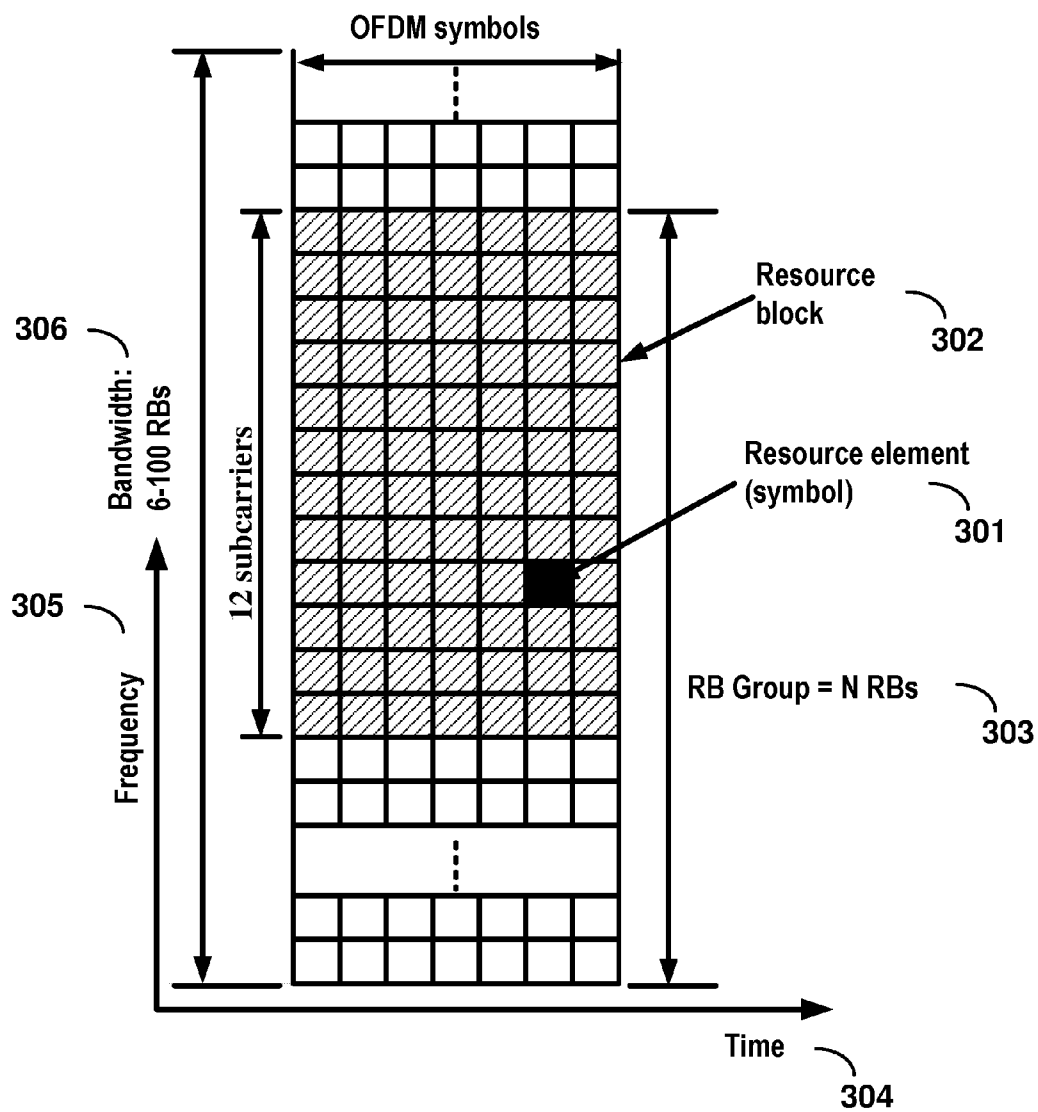

FIG. 3

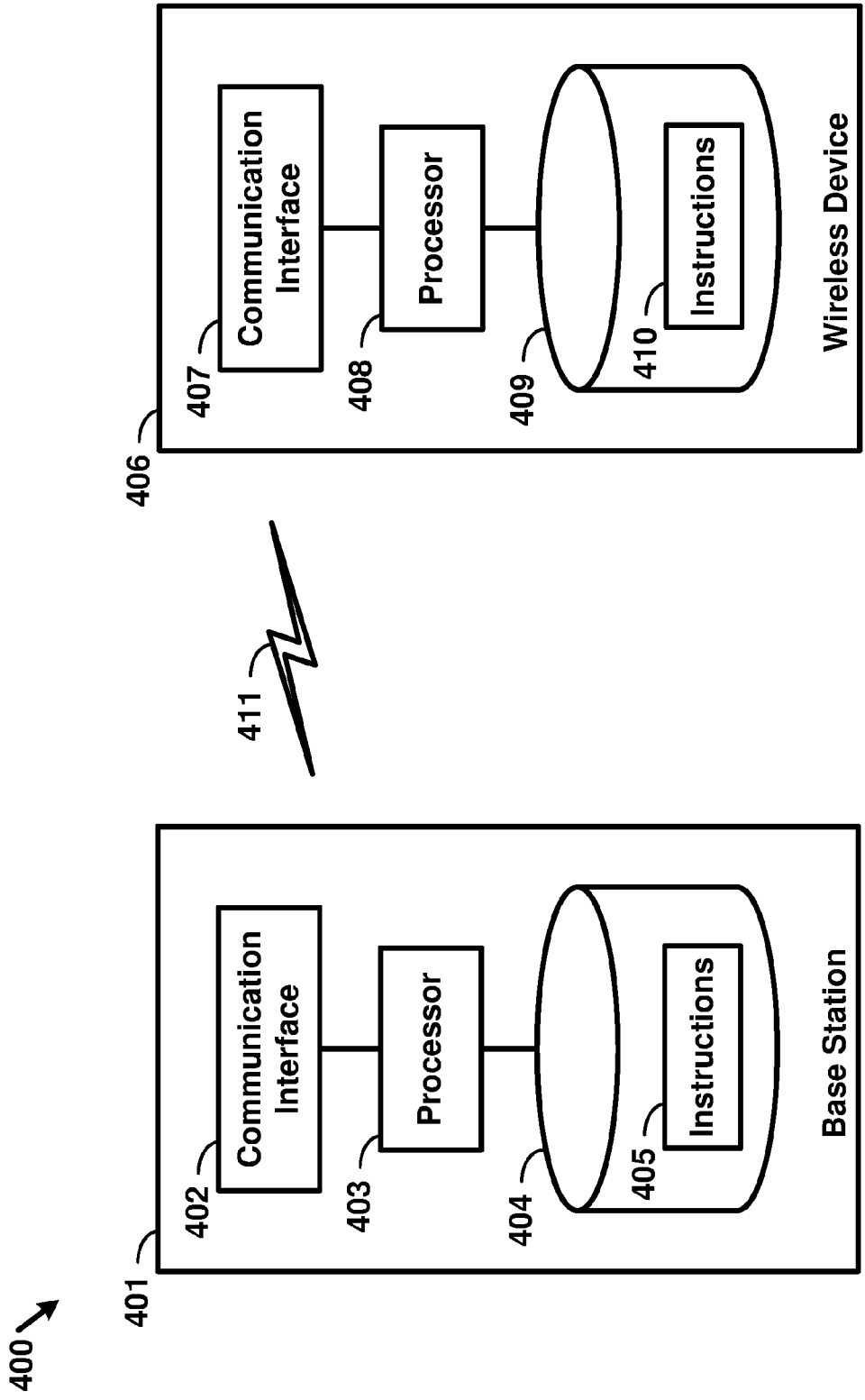

FIG. 4

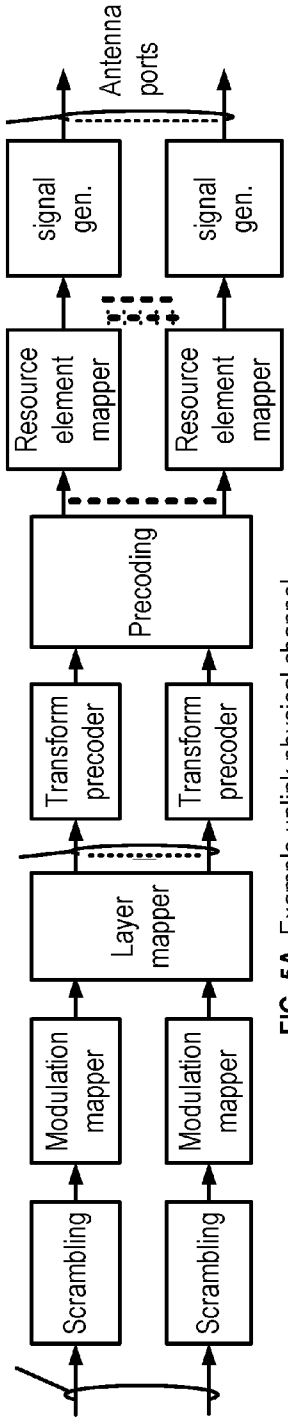

FIG. 5A Example uplink physical channel

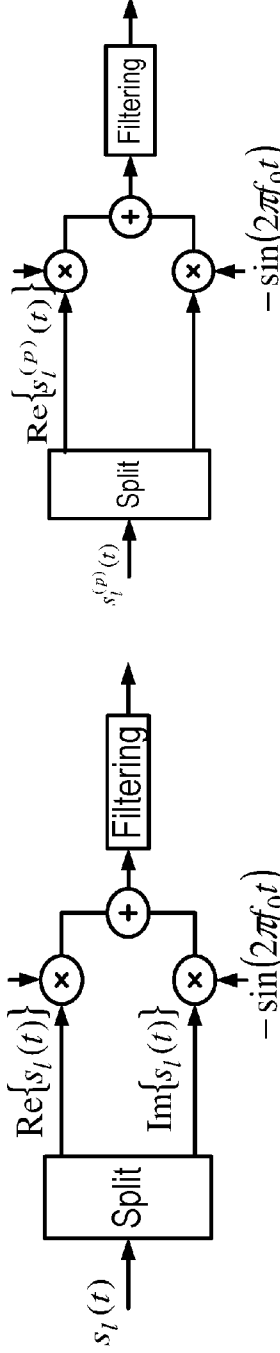

FIG. 5B Example uplink modulation

FIG. 5D Example downlink modulation

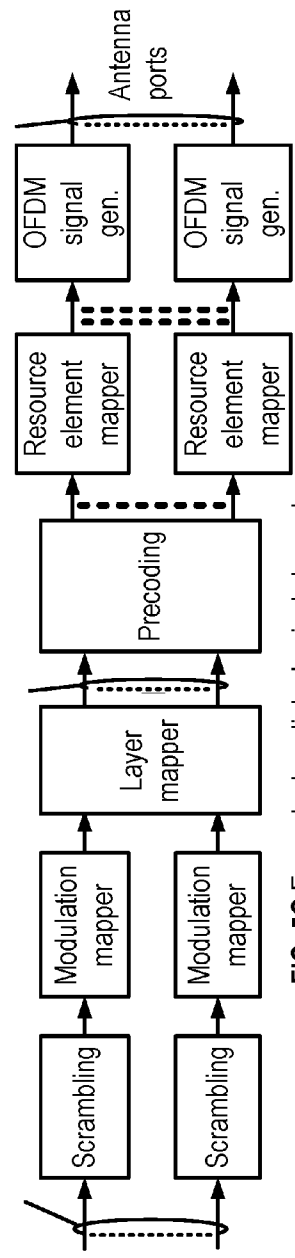
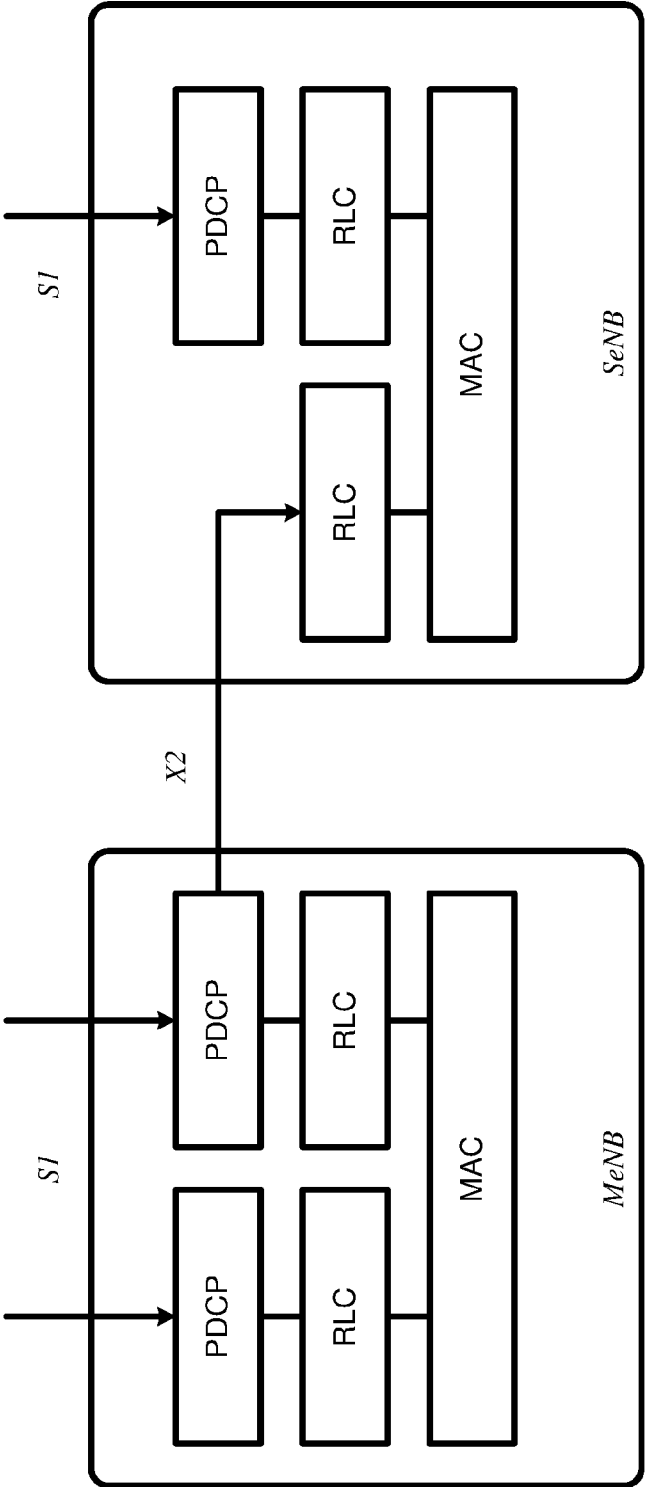
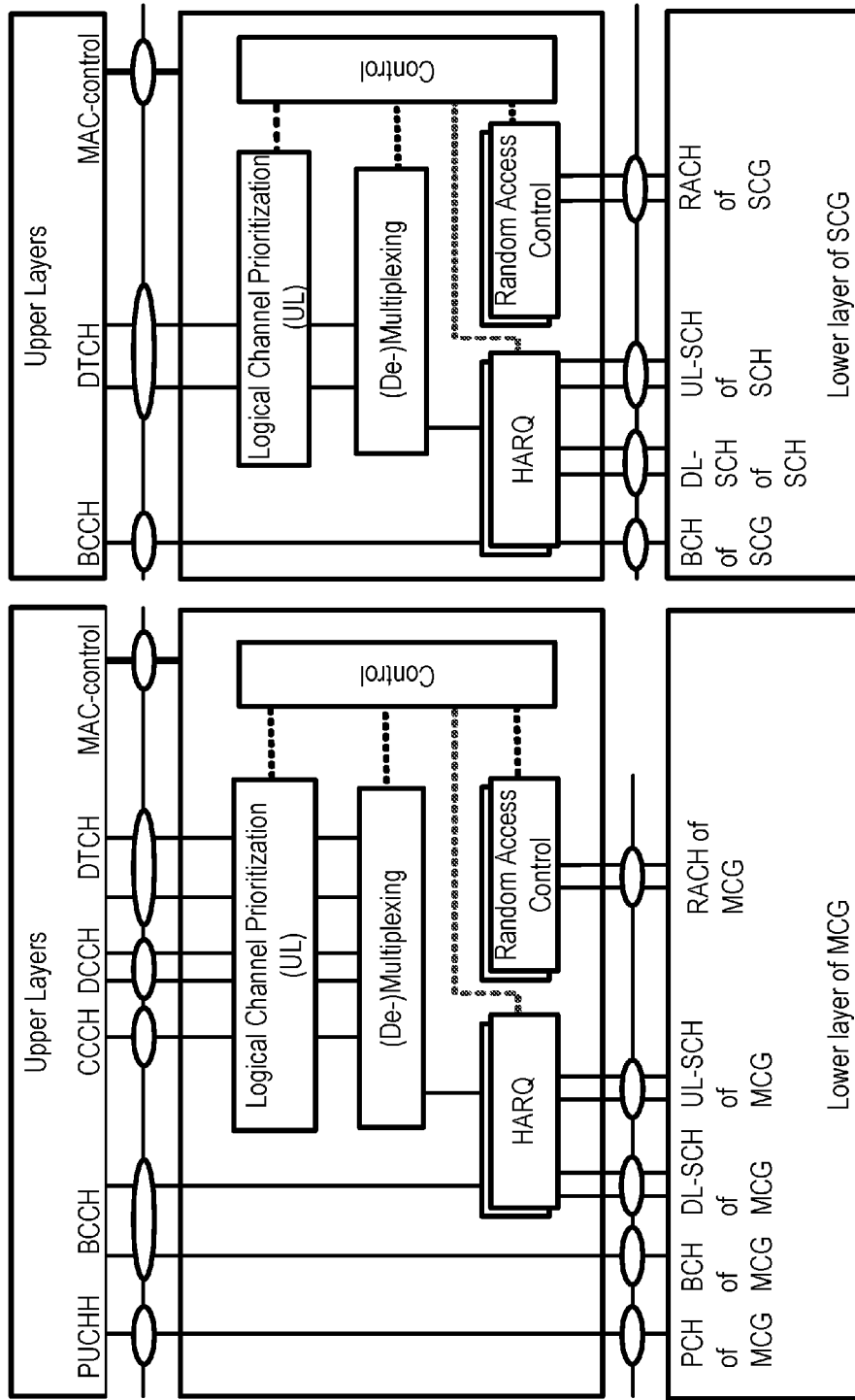

FIG. 5C Example downlink physical channel



Dual-Connectivity at eNB

FIG. 6



Dual-Connectivity- two MAC entities at UE side

FIG. 7

Example 1:

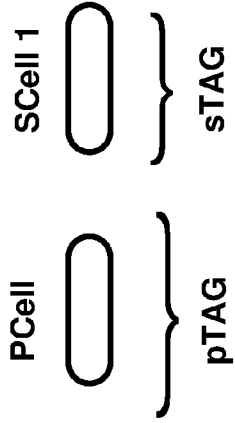

Example 2:

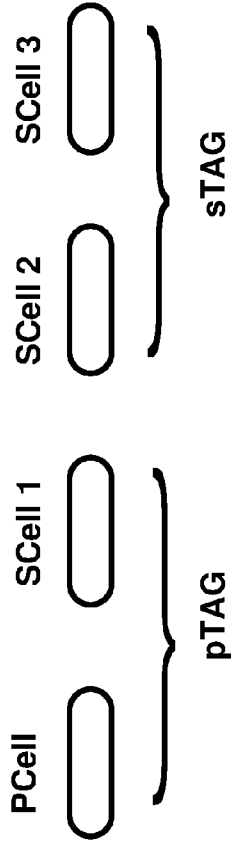

Example 3:

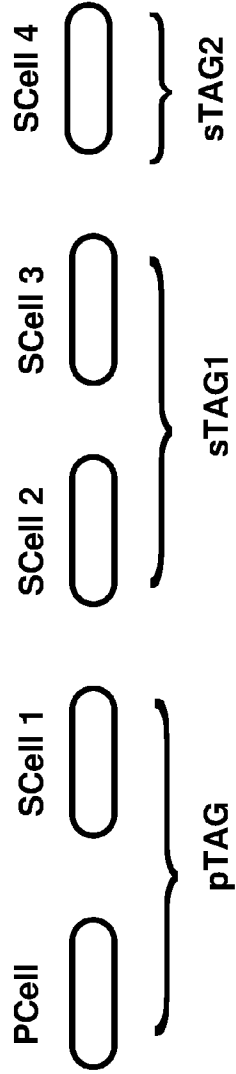

FIG. 8

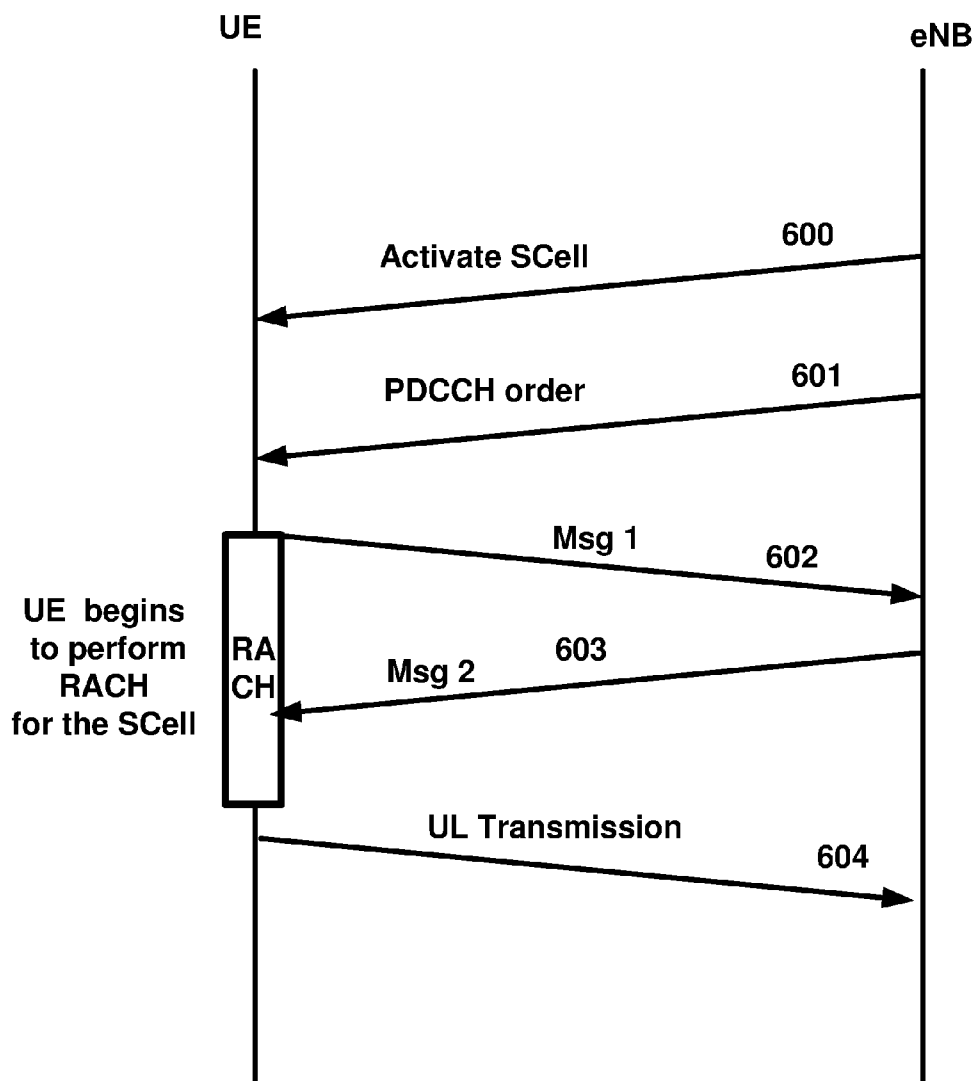

FIG. 9

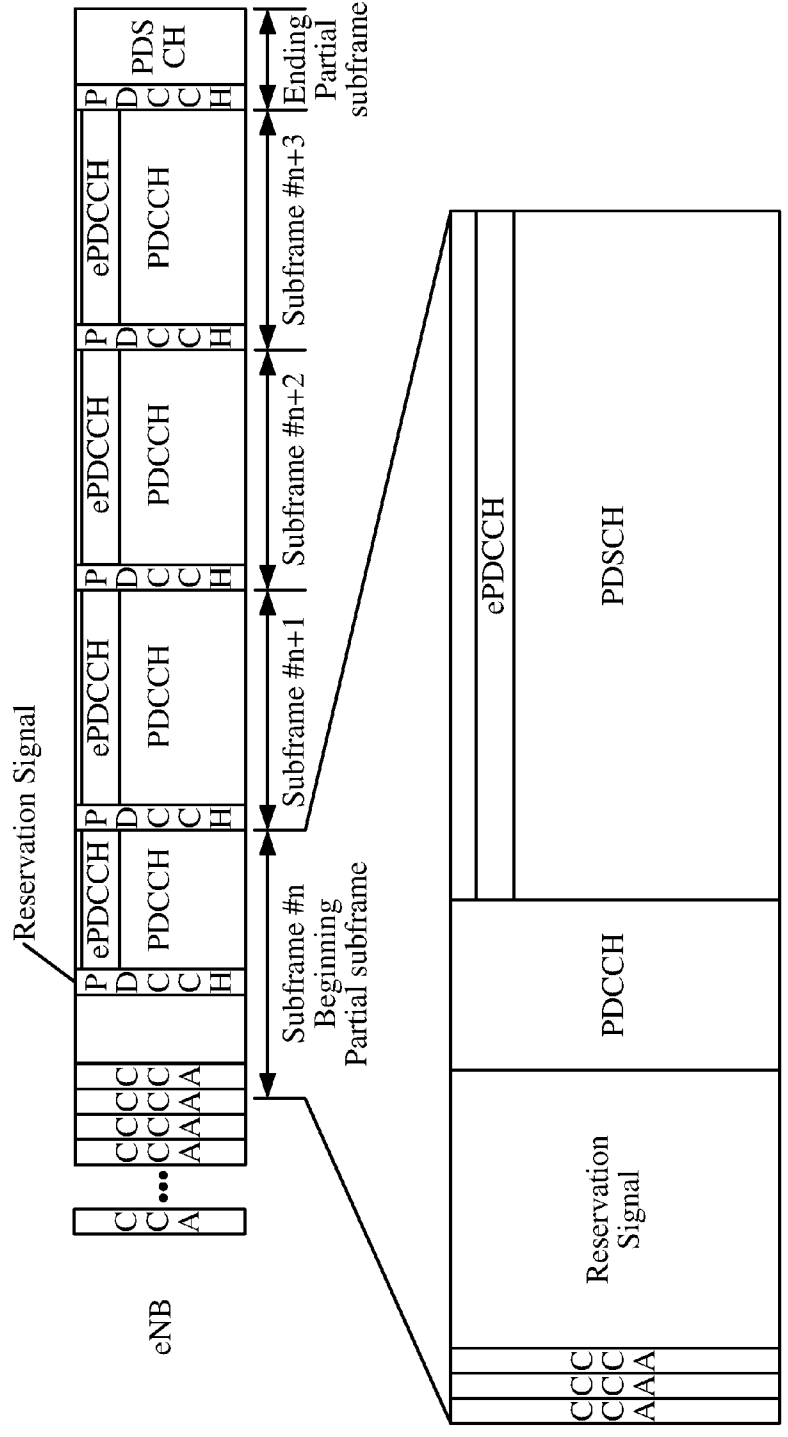
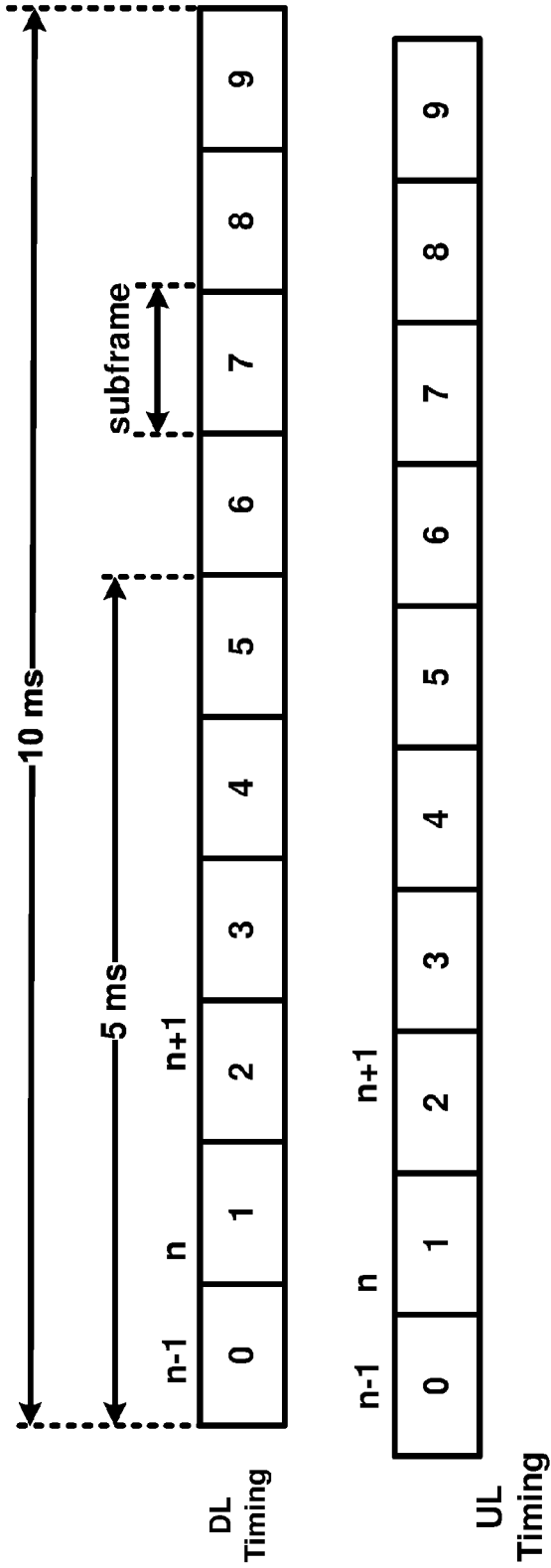

FIG. 10



Frame Structure Type 3: LAA DL and UL transmitted on the same frequency - Subframe timing reference

FIG. 11

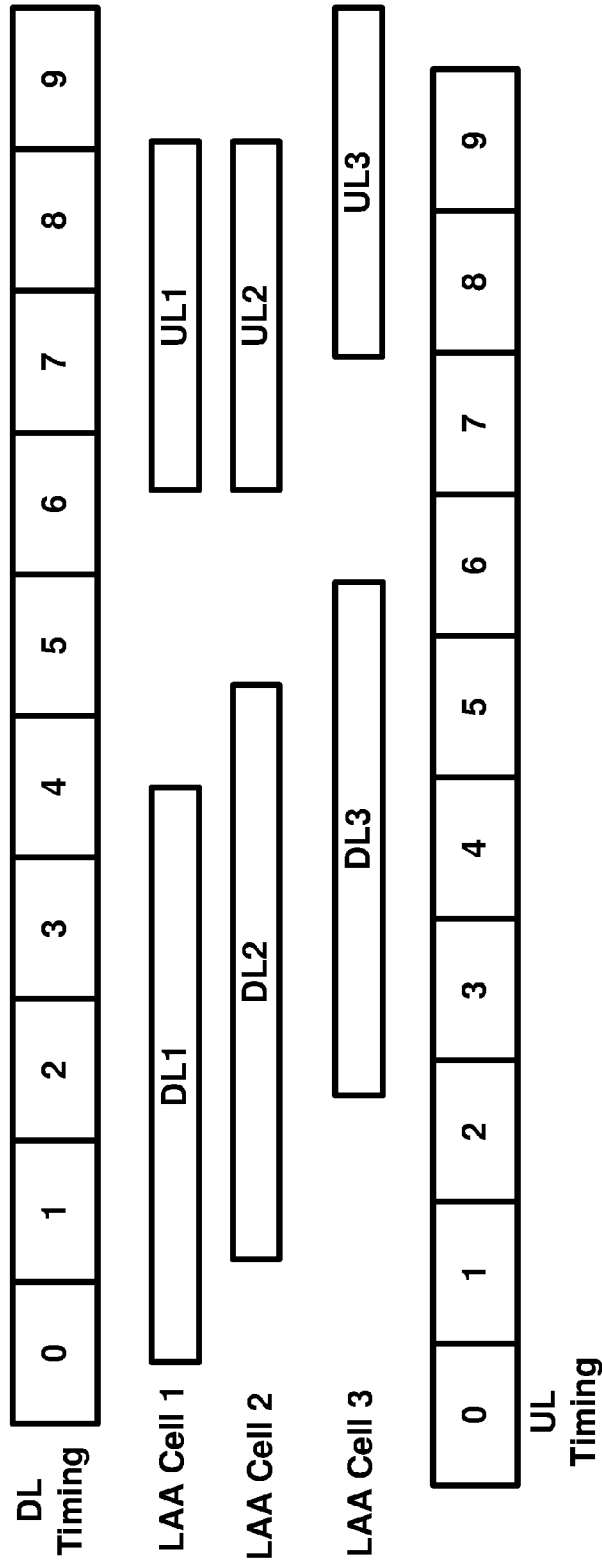

FIG. 12

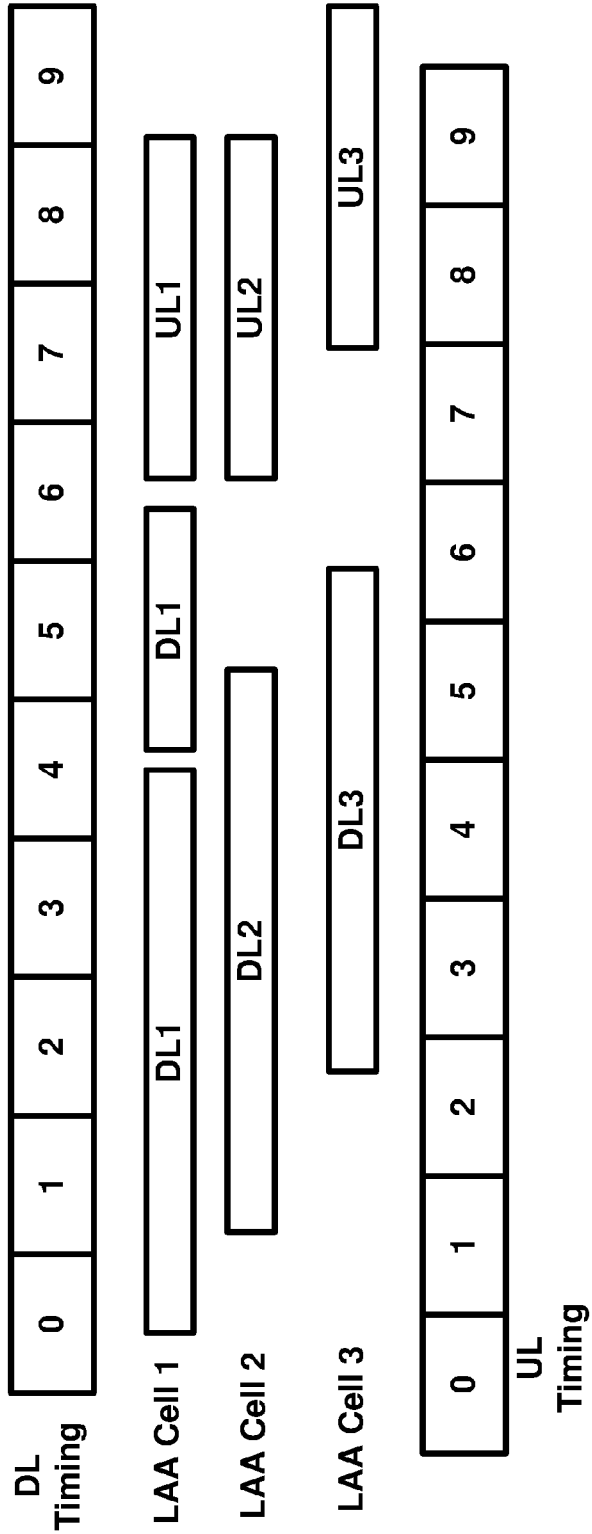

FIG. 13

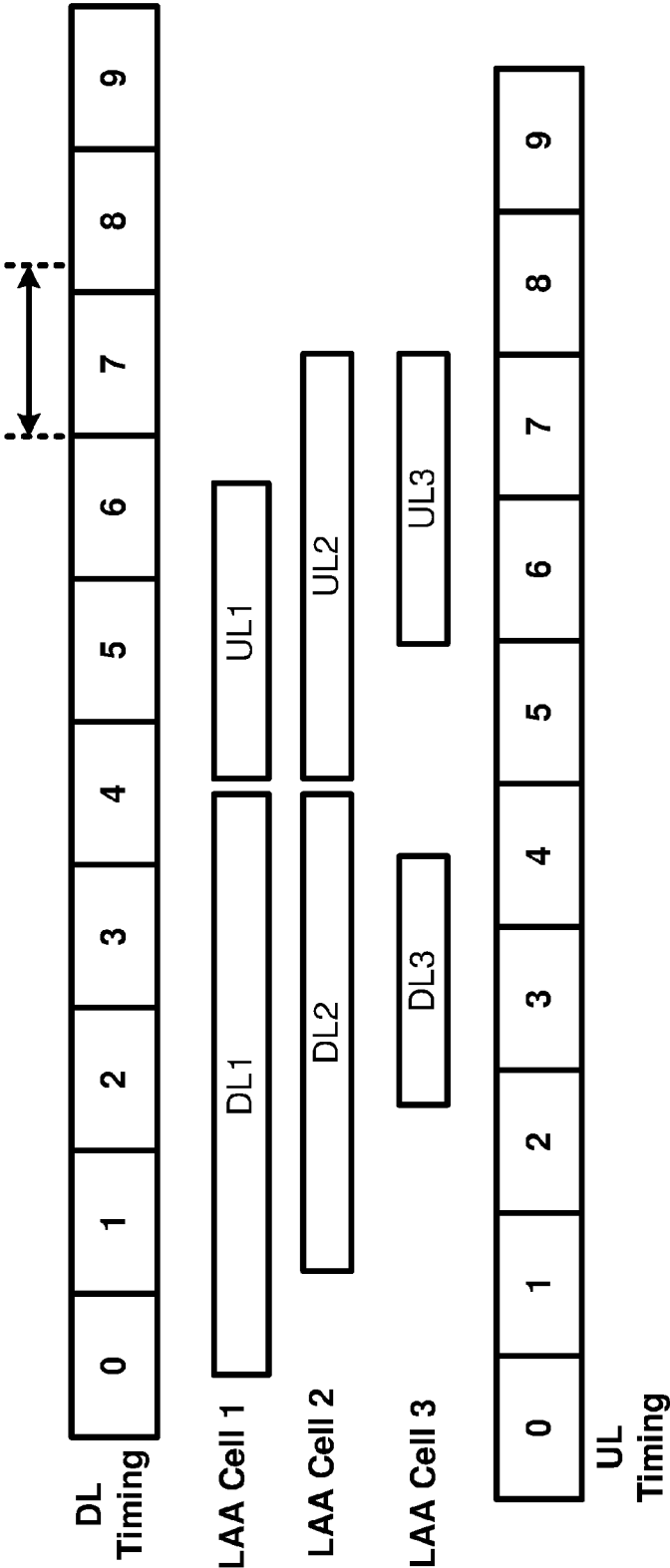

FIG. 14

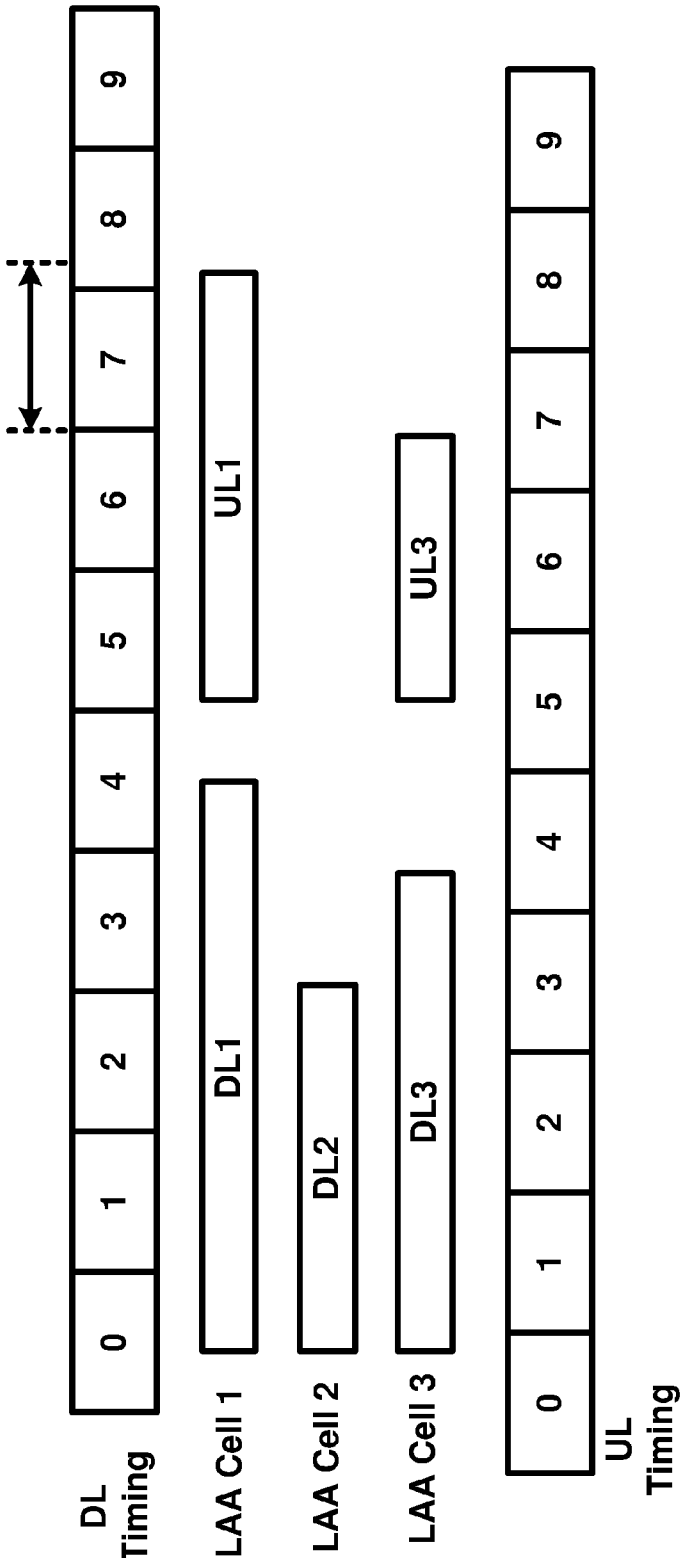

FIG. 15

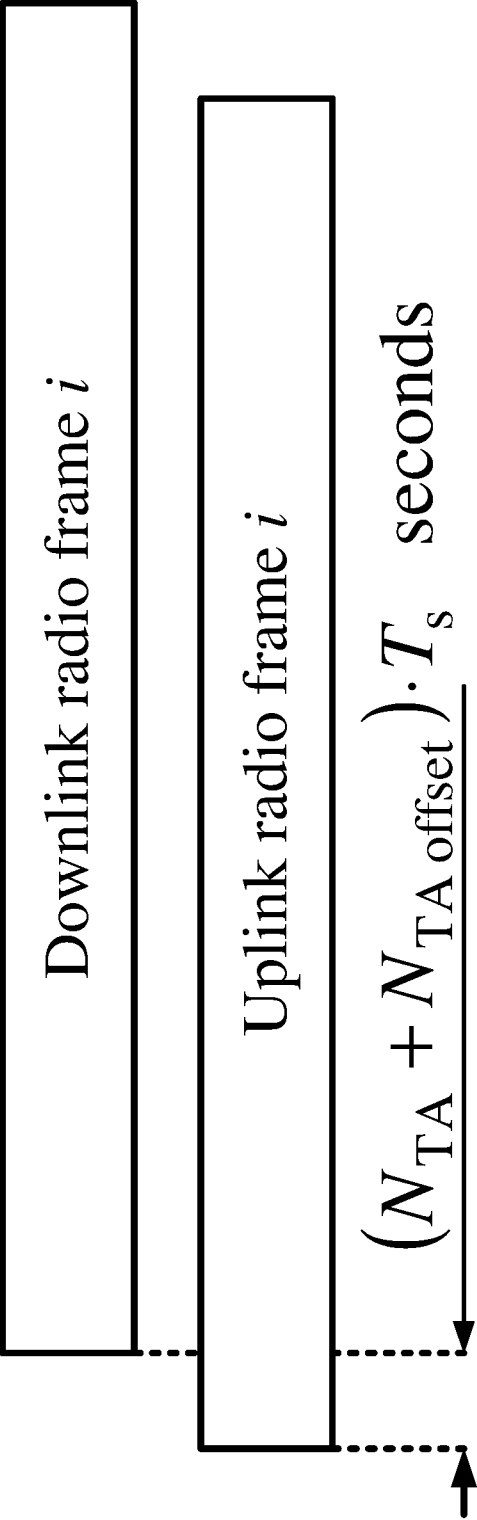
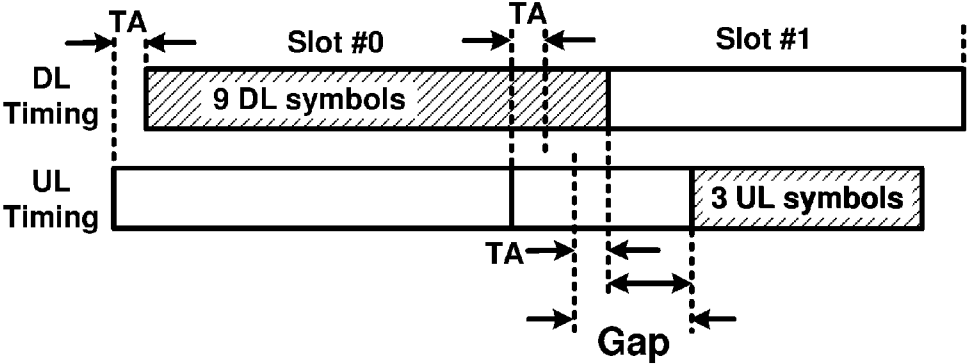
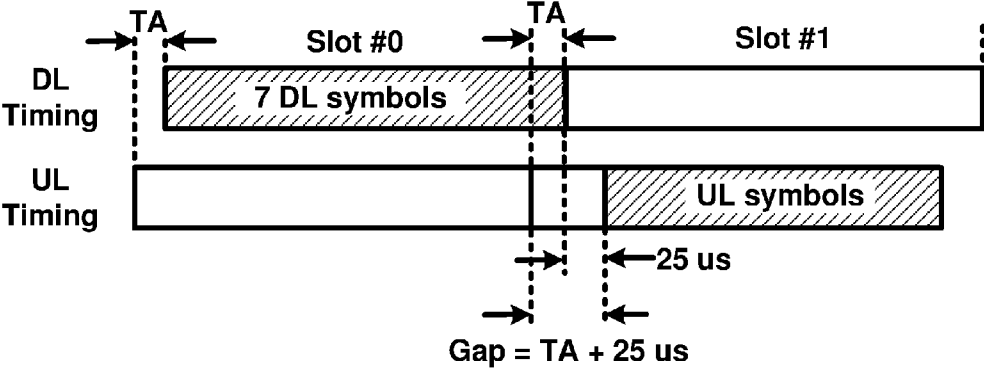

FIG. 16



Example DL and UL Timing in a UE



Example DL and UL Timing in a UE

FIG. 17

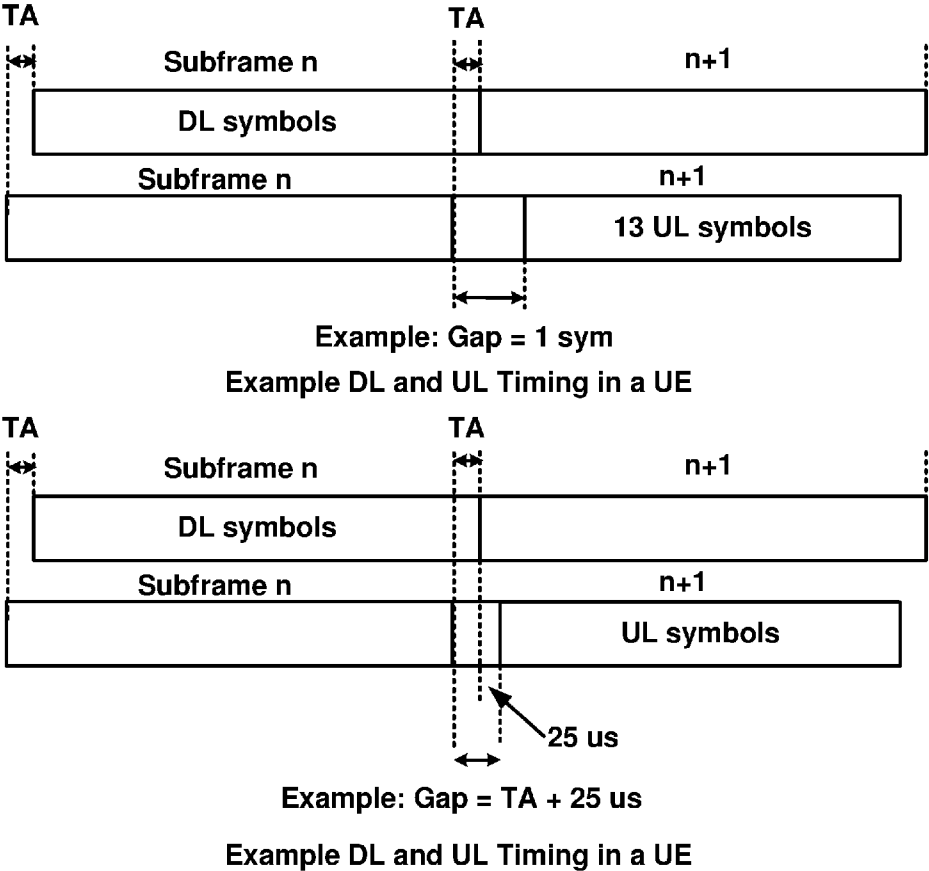

FIG. 18

Table: Configuration of special subframe (lengths of DwPTS/GP/UpPTS)

Special subframe configuration $30720 \cdot T_s = 1 \text{ms}$	DwPTS	Normal cyclic prefix in downlink/uplink			
		UpPTS X	Duration including DL/UL switch + TA + LBT (if applies); in symbols X=2	X=4	
0	$6592 \cdot T_s$ = 3 sym		10	8	6
1	$19760 \cdot T_s$ = 9 sym		4	2	-
2	$21952 \cdot T_s$ = 10 sym	$(1+X) \cdot 2192 \cdot T_s$	3	1	-
3	$24144 \cdot T_s$ = 11 sym		2	-	-
4	$26336 \cdot T_s$ = 12 sym		1	-	-
5	$6592 \cdot T_s$ = 3 sym		9	7	5
6	$19760 \cdot T_s$ = 9 sym		3	1	-
7	$21952 \cdot T_s$ = 10 sym	$(2+X) \cdot 2192 \cdot T_s$	2	-	-
8	$24144 \cdot T_s$ = 11 sym		1	-	-
9	$13168 \cdot T_s$ = 6 sym		6	4	2

FIG. 19

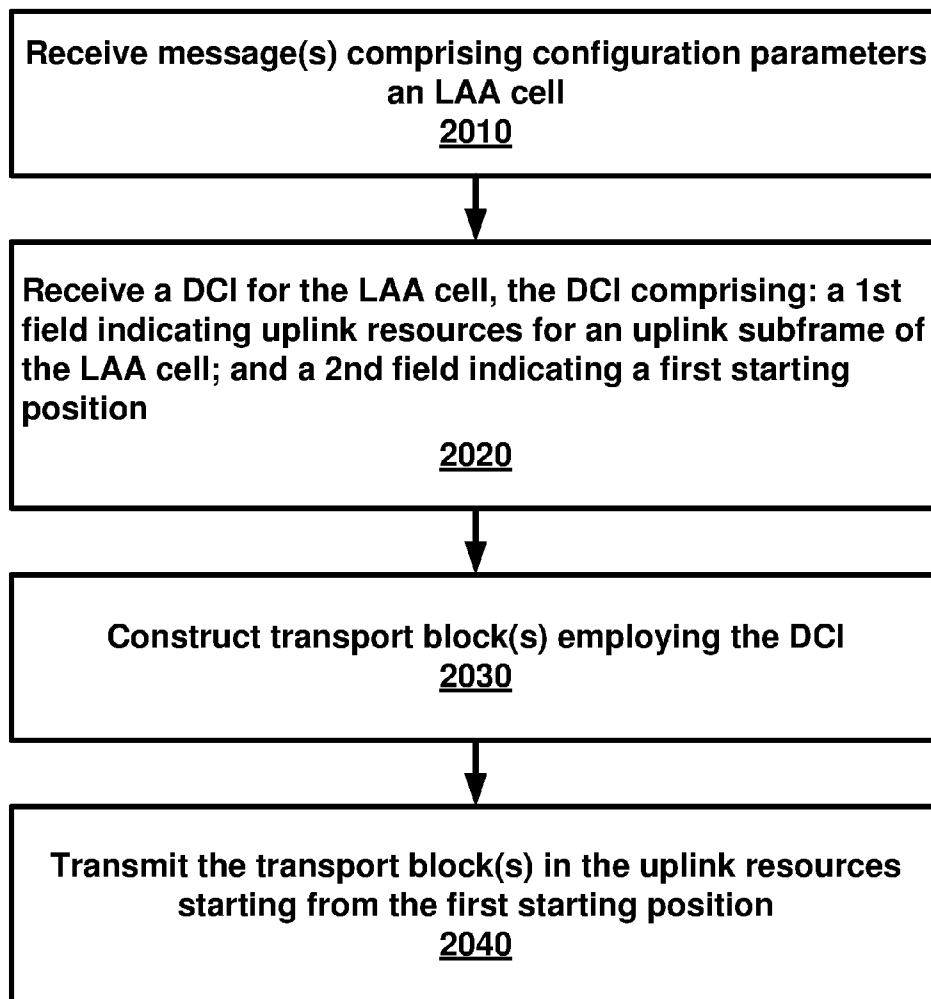

FIG. 20

UPLINK SIGNAL STARTING POSITION IN A WIRELESS DEVICE AND WIRELESS NETWORK

CROSS-REFERENCE TO RELATED APPLICATIONS

[0001] This application claims the benefit of U.S. Provisional Application No. 62/332,510, filed May 6, 2016, which is hereby incorporated by reference in its entirety.

BRIEF DESCRIPTION OF THE SEVERAL VIEWS OF THE DRAWINGS

[0002] Examples of several of the various embodiments of the present disclosure are described herein with reference to the drawings.

[0003] FIG. 1 is a diagram depicting example sets of OFDM subcarriers as per an aspect of an embodiment of the present disclosure.

[0004] FIG. 2 is a diagram depicting an example transmission time and reception time for two carriers in a carrier group as per an aspect of an embodiment of the present disclosure.

[0005] FIG. 3 is an example diagram depicting OFDM radio resources as per an aspect of an embodiment of the present disclosure.

[0006] FIG. 4 is an example block diagram of a base station and a wireless device as per an aspect of an embodiment of the present disclosure.

[0007] FIG. 5A, FIG. 5B, FIG. 5C and FIG. 5D are example diagrams for uplink and downlink signal transmission as per an aspect of an embodiment of the present disclosure.

[0008] FIG. 6 is an example diagram for a protocol structure with CA and DC as per an aspect of an embodiment of the present disclosure.

[0009] FIG. 7 is an example diagram for a protocol structure with CA and DC as per an aspect of an embodiment of the present disclosure.

[0010] FIG. 8 shows example TAG configurations as per an aspect of an embodiment of the present disclosure.

[0011] FIG. 9 is an example message flow in a random access process in a secondary TAG as per an aspect of an embodiment of the present disclosure.

[0012] FIG. 10 is an example diagram depicting a downlink burst as per an aspect of an embodiment of the present disclosure.

[0013] FIG. 11 is an example diagram depicting a plurality of cells as per an aspect of an embodiment of the present disclosure.

[0014] FIG. 12 is an example diagram depicting a plurality of cells as per an aspect of an embodiment of the present disclosure.

[0015] FIG. 13 is an example diagram depicting a plurality of cells as per an aspect of an embodiment of the present disclosure.

[0016] FIG. 14 is an example diagram depicting a plurality of cells as per an aspect of an embodiment of the present disclosure.

[0017] FIG. 15 is an example diagram depicting a plurality of cells as per an aspect of an embodiment of the present disclosure.

[0018] FIG. 16 is an example diagram depicting a timing advance as per an aspect of an embodiment of the present disclosure.

[0019] FIG. 17 is an example diagram depicting downlink and uplink subframe timing as per an aspect of an embodiment of the present disclosure.

[0020] FIG. 18 is an example diagram depicting downlink and uplink subframe timing as per an aspect of an embodiment of the present disclosure.

[0021] FIG. 19 is an example diagram depicting a subframe configuration as per an aspect of an embodiment of the present disclosure.

[0022] FIG. 20 is an example flow diagram as per an aspect of an embodiment of the present disclosure.

DETAILED DESCRIPTION OF EMBODIMENTS

[0023] Example embodiments of the present disclosure enable operation of carrier aggregation. Embodiments of the technology disclosed herein may be employed in the technical field of multicarrier communication systems.

[0024] The following Acronyms are used throughout the present disclosure:

- [0025] ASIC application-specific integrated circuit
- [0026] BPSK binary phase shift keying
- [0027] CA carrier aggregation
- [0028] CSI channel state information
- [0029] CDMA code division multiple access
- [0030] CSS common search space
- [0031] CPLD complex programmable logic devices
- [0032] CC component carrier
- [0033] DL downlink
- [0034] DCI downlink control information
- [0035] DC dual connectivity
- [0036] EPC evolved packet core
- [0037] E-UTRAN evolved-universal terrestrial radio access network
- [0038] FPGA field programmable gate arrays
- [0039] FDD frequency division multiplexing
- [0040] HDL hardware description languages
- [0041] HARQ hybrid automatic repeat request
- [0042] IE information element
- [0043] LAA licensed assisted access
- [0044] LTE long term evolution
- [0045] MCG master cell group
- [0046] MeNB master evolved node B
- [0047] MIB master information block
- [0048] MAC media access control
- [0049] MAC media access control
- [0050] MME mobility management entity
- [0051] NAS non-access stratum
- [0052] OFDM orthogonal frequency division multiplexing
- [0053] PDCP packet data convergence protocol
- [0054] PDU packet data unit
- [0055] PHY physical
- [0056] PDCCH physical downlink control channel
- [0057] PHICH physical HARQ indicator channel
- [0058] PUCCH physical uplink control channel
- [0059] PUSCH physical uplink shared channel
- [0060] PCell primary cell
- [0061] PCell primary cell
- [0062] PCC primary component carrier
- [0063] PSCell primary secondary cell
- [0064] pTAG primary timing advance group

[0065] QAM quadrature amplitude modulation
 [0066] QPSK quadrature phase shift keying
 [0067] RBG Resource Block Groups
 [0068] RLC radio link control
 [0069] RRC radio resource control
 [0070] RA random access
 [0071] RB resource blocks
 [0072] SCC secondary component carrier
 [0073] SCell secondary cell
 [0074] Scell secondary cells
 [0075] SCG secondary cell group
 [0076] SeNB secondary evolved node B
 [0077] sTAGs secondary timing advance group
 [0078] SDU service data unit
 [0079] S-GW serving gateway
 [0080] SRB signaling radio bearer
 [0081] SC-OFDM single carrier-OFDM
 [0082] SFN system frame number
 [0083] SIB system information block
 [0084] TAI tracking area identifier
 [0085] TAT time alignment timer
 [0086] TDD time division duplexing
 [0087] TDMA time division multiple access
 [0088] TA timing advance
 [0089] TAG timing advance group
 [0090] TB transport block
 [0091] UL uplink
 [0092] UE user equipment
 [0093] VHDL VHSIC hardware description language
 [0094] Example embodiments of the disclosure may be implemented using various physical layer modulation and transmission mechanisms. Example transmission mechanisms may include, but are not limited to: CDMA, OFDM, TDMA, Wavelet technologies, and/or the like. Hybrid transmission mechanisms such as TDMA/CDMA, and OFDM/CDMA may also be employed. Various modulation schemes may be applied for signal transmission in the physical layer. Examples of modulation schemes include, but are not limited to: phase, amplitude, code, a combination of these, and/or the like. An example radio transmission method may implement QAM using BPSK, QPSK, 16-QAM, 64-QAM, 256-QAM, and/or the like. Physical radio transmission may be enhanced by dynamically or semi-dynamically changing the modulation and coding scheme depending on transmission requirements and radio conditions.
 [0095] FIG. 1 is a diagram depicting example sets of OFDM subcarriers as per an aspect of an embodiment of the present disclosure. As illustrated in this example, arrow(s) in the diagram may depict a subcarrier in a multicarrier OFDM system. The OFDM system may use technology such as OFDM technology, DFTS-OFDM, SC-OFDM technology, or the like. For example, arrow 101 shows a subcarrier transmitting information symbols. FIG. 1 is for illustration purposes, and a typical multicarrier OFDM system may include more subcarriers in a carrier. For example, the number of subcarriers in a carrier may be in the range of 10 to 10,000 subcarriers. FIG. 1 shows two guard bands 106 and 107 in a transmission band. As illustrated in FIG. 1, guard band 106 is between subcarriers 103 and subcarriers 104. The example set of subcarriers A 102 includes subcarriers 103 and subcarriers 104. FIG. 1 also illustrates an example set of subcarriers B 105. As illustrated, there is no guard band between any two subcarriers in the example set of subcarriers B 105. Carriers in a multicarrier OFDM

communication system may be contiguous carriers, non-contiguous carriers, or a combination of both contiguous and non-contiguous carriers.

[0096] FIG. 2 is a diagram depicting an example transmission time and reception time for two carriers as per an aspect of an embodiment of the present disclosure. A multicarrier OFDM communication system may include one or more carriers, for example, ranging from 1 to 10 carriers. Carrier A 204 and carrier B 205 may have the same or different timing structures. Although FIG. 2 shows two synchronized carriers, carrier A 204 and carrier B 205 may or may not be synchronized with each other. Different radio frame structures may be supported for FDD and TDD duplex mechanisms. FIG. 2 shows an example FDD frame timing. Downlink and uplink transmissions may be organized into radio frames 201. In this example, the radio frame duration is 10 msec. Other frame durations, for example, in the range of 1 to 100 msec may also be supported. In this example, each 10 ms radio frame 201 may be divided into ten equally sized subframes 202. Other subframe durations such as 0.5 msec, 1 msec, 2 msec, and 5 msec may also be supported. Subframe(s) may consist of two or more slots (for example, slots 206 and 207). For the example of FDD, 10 subframes may be available for downlink transmission and 10 subframes may be available for uplink transmissions in each 10 ms interval. Uplink and downlink transmissions may be separated in the frequency domain. Slot(s) may include a plurality of OFDM symbols 203. The number of OFDM symbols 203 in a slot 206 may depend on the cyclic prefix length and subcarrier spacing.

[0097] FIG. 3 is a diagram depicting OFDM radio resources as per an aspect of an embodiment of the present disclosure. The resource grid structure in time 304 and frequency 305 is illustrated in FIG. 3. The quantity of downlink subcarriers or RBs (in this example 6 to 100 RBs) may depend, at least in part, on the downlink transmission bandwidth 306 configured in the cell. The smallest radio resource unit may be called a resource element (e.g. 301). Resource elements may be grouped into resource blocks (e.g. 302). Resource blocks may be grouped into larger radio resources called Resource Block Groups (RBG) (e.g. 303). The transmitted signal in slot 206 may be described by one or several resource grids of a plurality of subcarriers and a plurality of OFDM symbols. Resource blocks may be used to describe the mapping of certain physical channels to resource elements. Other pre-defined groupings of physical resource elements may be implemented in the system depending on the radio technology. For example, 24 subcarriers may be grouped as a radio block for a duration of 5 msec. In an illustrative example, a resource block may correspond to one slot in the time domain and 180 kHz in the frequency domain (for 15 KHz subcarrier bandwidth and 12 subcarriers).

[0098] FIG. 5A, FIG. 5B, FIG. 5C and FIG. 5D are example diagrams for uplink and downlink signal transmission as per an aspect of an embodiment of the present disclosure. FIG. 5A shows an example uplink physical channel. The baseband signal representing the physical uplink shared channel may perform the following processes. These functions are illustrated as examples and it is anticipated that other mechanisms may be implemented in various embodiments. The functions may comprise scrambling, modulation of scrambled bits to generate complex-valued symbols, mapping of the complex-valued modulation sym-

bols onto one or several transmission layers, transform precoding to generate complex-valued symbols, precoding of the complex-valued symbols, mapping of precoded complex-valued symbols to resource elements, generation of complex-valued time-domain DFTS-OFDM/SC-FDMA signal for each antenna port, and/or the like.

[0099] Example modulation and up-conversion to the carrier frequency of the complex-valued DFTS-OFDM/SC-FDMA baseband signal for each antenna port and/or the complex-valued PRACH baseband signal is shown in FIG. 5B. Filtering may be employed prior to transmission.

[0100] An example structure for Downlink Transmissions is shown in FIG. 5C. The baseband signal representing a downlink physical channel may perform the following processes. These functions are illustrated as examples and it is anticipated that other mechanisms may be implemented in various embodiments. The functions include scrambling of coded bits in each of the codewords to be transmitted on a physical channel; modulation of scrambled bits to generate complex-valued modulation symbols; mapping of the complex-valued modulation symbols onto one or several transmission layers; precoding of the complex-valued modulation symbols on each layer for transmission on the antenna ports; mapping of complex-valued modulation symbols for each antenna port to resource elements; generation of complex-valued time-domain OFDM signal for each antenna port, and/or the like.

[0101] Example modulation and up-conversion to the carrier frequency of the complex-valued OFDM baseband signal for each antenna port is shown in FIG. 5D. Filtering may be employed prior to transmission.

[0102] FIG. 4 is an example block diagram of a base station 401 and a wireless device 406, as per an aspect of an embodiment of the present disclosure. A communication network 400 may include at least one base station 401 and at least one wireless device 406. The base station 401 may include at least one communication interface 402, at least one processor 403, and at least one set of program code instructions 405 stored in non-transitory memory 404 and executable by the at least one processor 403. The wireless device 406 may include at least one communication interface 407, at least one processor 408, and at least one set of program code instructions 410 stored in non-transitory memory 409 and executable by the at least one processor 408. Communication interface 402 in base station 401 may be configured to engage in communication with communication interface 407 in wireless device 406 via a communication path that includes at least one wireless link 411. Wireless link 411 may be a bi-directional link. Communication interface 407 in wireless device 406 may also be configured to engage in a communication with communication interface 402 in base station 401. Base station 401 and wireless device 406 may be configured to send and receive data over wireless link 411 using multiple frequency carriers. According to aspects of an embodiment, transceiver(s) may be employed. A transceiver is a device that includes both a transmitter and receiver. Transceivers may be employed in devices such as wireless devices, base stations, relay nodes, and/or the like. Example embodiments for radio technology implemented in communication interface 402, 407 and wireless link 411 are illustrated in FIG. 1, FIG. 2, FIG. 3, FIG. 5, and associated text.

[0103] An interface may be a hardware interface, a firmware interface, a software interface, and/or a combination

thereof. The hardware interface may include connectors, wires, electronic devices such as drivers, amplifiers, and/or the like. A software interface may include code stored in a memory device to implement protocol(s), protocol layers, communication drivers, device drivers, combinations thereof, and/or the like. A firmware interface may include a combination of embedded hardware and code stored in and/or in communication with a memory device to implement connections, electronic device operations, protocol(s), protocol layers, communication drivers, device drivers, hardware operations, combinations thereof, and/or the like.

[0104] The term configured may relate to the capacity of a device whether the device is in an operational or non-operational state. Configured may also refer to specific settings in a device that effect the operational characteristics of the device whether the device is in an operational or non-operational state. In other words, the hardware, software, firmware, registers, memory values, and/or the like may be “configured” within a device, whether the device is in an operational or nonoperational state, to provide the device with specific characteristics. Terms such as “a control message to cause in a device” may mean that a control message has parameters that may be used to configure specific characteristics in the device, whether the device is in an operational or non-operational state.

[0105] According to various aspects of an embodiment, an LTE network may include a multitude of base stations, providing a user plane PDCP/RLC/MAC/PHY and control plane (RRC) protocol terminations towards the wireless device. The base station(s) may be interconnected with other base station(s) (for example, interconnected employing an X2 interface). Base stations may also be connected employing, for example, an S1 interface to an EPC. For example, base stations may be interconnected to the MME employing the S1-MME interface and to the S-G) employing the S1-U interface. The S1 interface may support a many-to-many relation between MMEs/Serving Gateways and base stations. A base station may include many sectors for example: 1, 2, 3, 4, or 6 sectors. A base station may include many cells, for example, ranging from 1 to 50 cells or more. A cell may be categorized, for example, as a primary cell or secondary cell. At RRC connection establishment/re-establishment/handover, one serving cell may provide the NAS (non-access stratum) mobility information (e.g. TAI), and at RRC connection re-establishment/handover, one serving cell may provide the security input. This cell may be referred to as the Primary Cell (PCell). In the downlink, the carrier corresponding to the PCell may be the Downlink Primary Component Carrier (DL PCC), while in the uplink, the carrier corresponding to the PCell may be the Uplink Primary Component Carrier (UL PCC). Depending on wireless device capabilities, Secondary Cells (SCells) may be configured to form together with the PCell a set of serving cells. In the downlink, the carrier corresponding to an SCell may be a Downlink Secondary Component Carrier (DL SCC), while in the uplink, it may be an Uplink Secondary Component Carrier (UL SCC). An SCell may or may not have an uplink carrier.

[0106] A cell, comprising a downlink carrier and optionally an uplink carrier, may be assigned a physical cell ID and a cell index. A carrier (downlink or uplink) may belong to only one cell. The cell ID or Cell index may also identify the downlink carrier or uplink carrier of the cell (depending on the context it is used). In the specification, cell ID may be

equally referred to a carrier ID, and cell index may be referred to carrier index. In implementation, the physical cell ID or cell index may be assigned to a cell. A cell ID may be determined using a synchronization signal transmitted on a downlink carrier. A cell index may be determined using RRC messages. For example, when the specification refers to a first physical cell ID for a first downlink carrier, the specification may mean the first physical cell ID is for a cell comprising the first downlink carrier. The same concept may apply, for example, to carrier activation. When the specification indicates that a first carrier is activated, the specification may also mean that the cell comprising the first carrier is activated.

[0107] Embodiments may be configured to operate as needed. The disclosed mechanism may be performed when certain criteria are met, for example, in a wireless device, a base station, a radio environment, a network, a combination of the above, and/or the like. Example criteria may be based, at least in part, on for example, traffic load, initial system set up, packet sizes, traffic characteristics, a combination of the above, and/or the like. When the one or more criteria are met, various example embodiments may be applied. Therefore, it may be possible to implement example embodiments that selectively implement disclosed protocols.

[0108] A base station may communicate with a mix of wireless devices. Wireless devices may support multiple technologies, and/or multiple releases of the same technology. Wireless devices may have some specific capability (ies) depending on its wireless device category and/or capability(ies). A base station may comprise multiple sectors. When this disclosure refers to a base station communicating with a plurality of wireless devices, this disclosure may refer to a subset of the total wireless devices in a coverage area. This disclosure may refer to, for example, a plurality of wireless devices of a given LTE release with a given capability and in a given sector of the base station. The plurality of wireless devices in this disclosure may refer to a selected plurality of wireless devices, and/or a subset of total wireless devices in a coverage area which perform according to disclosed methods, and/or the like. There may be a plurality of wireless devices in a coverage area that may not comply with the disclosed methods, for example, because those wireless devices perform based on older releases of LTE technology.

[0109] FIG. 6 and FIG. 7 are example diagrams for protocol structure with CA and DC as per an aspect of an embodiment of the present disclosure. E-UTRAN may support Dual Connectivity (DC) operation whereby a multiple RX/TX UE in RRC_CONNECTED may be configured to utilize radio resources provided by two schedulers located in two eNBs connected via a non-ideal backhaul over the X2 interface. eNBs involved in DC for a certain UE may assume two different roles: an eNB may either act as an MeNB or as an SeNB. In DC a UE may be connected to one MeNB and one SeNB. Mechanisms implemented in DC may be extended to cover more than two eNBs. FIG. 7 illustrates one example structure for the UE side MAC entities when a Master Cell Group (MCG) and a Secondary Cell Group (SCG) are configured, and it may not restrict implementation. Media Broadcast Multicast Service (MBMS) reception is not shown in this figure for simplicity.

[0110] In DC, the radio protocol architecture that a particular bearer uses may depend on how the bearer is setup. Three alternatives may exist, an MCG bearer, an SCG bearer

and a split bearer as shown in FIG. 6. RRC may be located in MeNB and SRBs may be configured as a MCG bearer type and may use the radio resources of the MeNB. DC may also be described as having at least one bearer configured to use radio resources provided by the SeNB. DC may or may not be configured/implemented in example embodiments of the disclosure.

[0111] In the case of DC, the UE may be configured with two MAC entities: one MAC entity for MeNB, and one MAC entity for SeNB. In DC, the configured set of serving cells for a UE may comprise two subsets: the Master Cell Group (MCG) containing the serving cells of the MeNB, and the Secondary Cell Group (SCG) containing the serving cells of the SeNB. For a SCG, one or more of the following may be applied. At least one cell in the SCG may have a configured UL CC and one of them, named PSCell (or PCell of SCG, or sometimes called PCell), may be configured with PUCCH resources. When the SCG is configured, there may be at least one SCG bearer or one Split bearer. Upon detection of a physical layer problem or a random access problem on a PSCell, or the maximum number of RLC retransmissions has been reached associated with the SCG, or upon detection of an access problem on a PSCell during a SCG addition or a SCG change: a RRC connection re-establishment procedure may not be triggered, UL transmissions towards cells of the SCG may be stopped, and a MeNB may be informed by the UE of a SCG failure type. For split bearer, the DL data transfer over the MeNB may be maintained. The RLC AM bearer may be configured for the split bearer. Like a PCell, a PSCell may not be de-activated. A PSCell may be changed with a SCG change (for example, with a security key change and a RACH procedure), and/or neither a direct bearer type change between a Split bearer and a SCG bearer nor simultaneous configuration of a SCG and a Split bearer may be supported.

[0112] With respect to the interaction between a MeNB and a SeNB, one or more of the following principles may be applied. The MeNB may maintain the RRM measurement configuration of the UE and may, (for example, based on received measurement reports or traffic conditions or bearer types), decide to ask a SeNB to provide additional resources (serving cells) for a UE. Upon receiving a request from the MeNB, a SeNB may create a container that may result in the configuration of additional serving cells for the UE (or decide that it has no resource available to do so). For UE capability coordination, the MeNB may provide (part of) the AS configuration and the UE capabilities to the SeNB. The MeNB and the SeNB may exchange information about a UE configuration by employing RRC containers (inter-node messages) carried in X2 messages. The SeNB may initiate a reconfiguration of its existing serving cells (for example, a PUCCH towards the SeNB). The SeNB may decide which cell is the PSCell within the SCG. The MeNB may not change the content of the RRC configuration provided by the SeNB. In the case of a SCG addition and a SCG SCell addition, the MeNB may provide the latest measurement results for the SCG cell(s). Both a MeNB and a SeNB may know the SFN and subframe offset of each other by OAM, (for example, for the purpose of DRX alignment and identification of a measurement gap). In an example, when adding a new SCG SCell, dedicated RRC signaling may be used for sending required system information of the cell as for CA, except for the SFN acquired from a MIB of the PSCell of a SCG.

[0113] In an example, serving cells may be grouped in a TA group (TAG). Serving cells in one TAG may use the same timing reference. For a given TAG, user equipment (UE) may use at least one downlink carrier as a timing reference. For a given TAG, a UE may synchronize uplink subframe and frame transmission timing of uplink carriers belonging to the same TAG. In an example, serving cells having an uplink to which the same TA applies may correspond to serving cells hosted by the same receiver. A UE supporting multiple TAs may support two or more TA groups. One TA group may contain the PCell and may be called a primary TAG (pTAG). In a multiple TAG configuration, at least one TA group may not contain the PCell and may be called a secondary TAG (sTAG). In an example, carriers within the same TA group may use the same TA value and/or the same timing reference. When DC is configured, cells belonging to a cell group (MCG or SCG) may be grouped into multiple TAGs including a pTAG and one or more sTAGs.

[0114] FIG. 8 shows example TAG configurations as per an aspect of an embodiment of the present disclosure. In Example 1, pTAG comprises a PCell, and an sTAG comprises SCell1. In Example 2, a pTAG comprises a PCell and SCell1, and an sTAG comprises SCell2 and SCell3. In Example 3, pTAG comprises PCell and SCell1, and an sTAG1 includes SCell2 and SCell3, and sTAG2 comprises SCell4. Up to four TAGs may be supported in a cell group (MCG or SCG) and other example TAG configurations may also be provided. In various examples in this disclosure, example mechanisms are described for a pTAG and an sTAG. Some of the example mechanisms may be applied to configurations with multiple sTAGs.

[0115] In an example, an eNB may initiate an RA procedure via a PDCCH order for an activated SCell. This PDCCH order may be sent on a scheduling cell of this SCell. When cross carrier scheduling is configured for a cell, the scheduling cell may be different than the cell that is employed for preamble transmission, and the PDCCH order may include an SCell index. At least a non-contention based RA procedure may be supported for SCell(s) assigned to sTAG(s).

[0116] FIG. 9 is an example message flow in a random access process in a secondary TAG as per an aspect of an embodiment of the present disclosure. An eNB transmits an activation command **600** to activate an SCell. A preamble **602** (Msg1) may be sent by a UE in response to a PDCCH order **601** on an SCell belonging to an sTAG. In an example embodiment, preamble transmission for SCells may be controlled by the network using PDCCH format 1A. Msg2 message **603** (RAR: random access response) in response to the preamble transmission on the SCell may be addressed to RA-RNTI in a PCell common search space (CSS). Uplink packets **604** may be transmitted on the SCell in which the preamble was transmitted.

[0117] According to an embodiment, initial timing alignment may be achieved through a random access procedure. This may involve a UE transmitting a random access preamble and an eNB responding with an initial TA command NTA (amount of timing advance) within a random access response window. The start of the random access preamble may be aligned with the start of a corresponding uplink subframe at the UE assuming NTA=0. The eNB may estimate the uplink timing from the random access preamble transmitted by the UE. The TA command may be derived by

the eNB based on the estimation of the difference between the desired UL timing and the actual UL timing. The UE may determine the initial uplink transmission timing relative to the corresponding downlink of the sTAG on which the preamble is transmitted.

[0118] The mapping of a serving cell to a TAG may be configured by a serving eNB with RRC signaling. The mechanism for TAG configuration and reconfiguration may be based on RRC signaling. According to various aspects of an embodiment, when an eNB performs an SCell addition configuration, the related TAG configuration may be configured for the SCell. In an example embodiment, an eNB may modify the TAG configuration of an SCell by removing (releasing) the SCell and adding (configuring) a new SCell (with the same physical cell ID and frequency) with an updated TAG ID. The new SCell with the updated TAG ID may initially be inactive subsequent to being assigned the updated TAG ID. The eNB may activate the updated new SCell and start scheduling packets on the activated SCell. In an example implementation, it may not be possible to change the TAG associated with an SCell, but rather, the SCell may need to be removed and a new SCell may need to be added with another TAG. For example, if there is a need to move an SCell from an sTAG to a pTAG, at least one RRC message, (for example, at least one RRC reconfiguration message), may be sent to the UE to reconfigure TAG configurations by releasing the SCell and then configuring the SCell as a part of the pTAG. When an SCell is added/configured without a TAG index, the SCell may be explicitly assigned to the pTAG. The PCell may not change its TA group and may be a member of the pTAG.

[0119] The purpose of an RRC connection reconfiguration procedure may be to modify an RRC connection, (for example, to establish, modify and/or release RBs, to perform handover, to setup, modify, and/or release measurements, to add, modify, and/or release SCells). If the received RRC Connection Reconfiguration message includes the sCellToReleaseList, the UE may perform an SCell release. If the received RRC Connection Reconfiguration message includes the sCellToAddModList, the UE may perform SCell additions or modification.

[0120] In LTE Release-10 and Release-11 CA, a PUCCH may only be transmitted on the PCell (PSCell) to an eNB. In LTE-Release 12 and earlier, a UE may transmit PUCCH information on one cell (PCell or PSCell) to a given eNB.

[0121] As the number of CA capable UEs and also the number of aggregated carriers increase, the number of PUCCHs and also the PUCCH payload size may increase. Accommodating the PUCCH transmissions on the PCell may lead to a high PUCCH load on the PCell. A PUCCH on an SCell may be introduced to offload the PUCCH resource from the PCell. More than one PUCCH may be configured for example, a PUCCH on a PCell and another PUCCH on an SCell. In the example embodiments, one, two or more cells may be configured with PUCCH resources for transmitting CSI/ACK/NACK to a base station. Cells may be grouped into multiple PUCCH groups, and one or more cell within a group may be configured with a PUCCH. In an example configuration, one SCell may belong to one PUCCH group. SCells with a configured PUCCH transmitted to a base station may be called a PUCCH SCell, and a cell group with a common PUCCH resource transmitted to the same base station may be called a PUCCH group.

[0122] In an example embodiment, a MAC entity may have a configurable timer `timeAlignmentTimer` per TAG. The `timeAlignmentTimer` may be used to control how long the MAC entity considers the Serving Cells belonging to the associated TAG to be uplink time aligned. The MAC entity may, when a Timing Advance Command MAC control element is received, apply the Timing Advance Command for the indicated TAG; start or restart the `timeAlignmentTimer` associated with the indicated TAG. The MAC entity may, when a Timing Advance Command is received in a Random Access Response message for a serving cell belonging to a TAG and/or if the Random Access Preamble was not selected by the MAC entity, apply the Timing Advance Command for this TAG and start or restart the `timeAlignmentTimer` associated with this TAG. Otherwise, if the `timeAlignmentTimer` associated with this TAG is not running, the Timing Advance Command for this TAG may be applied and the `timeAlignmentTimer` associated with this TAG started. When the contention resolution is considered not successful, a `timeAlignmentTimer` associated with this TAG may be stopped. Otherwise, the MAC entity may ignore the received Timing Advance Command.

[0123] In example embodiments, a timer is running once it is started, until it is stopped or until it expires; otherwise it may not be running. A timer can be started if it is not running or restarted if it is running. For example, a timer may be started or restarted from its initial value.

[0124] Example embodiments of the disclosure may enable operation of multi-carrier communications. Other example embodiments may comprise a non-transitory tangible computer readable media comprising instructions executable by one or more processors to cause operation of multi-carrier communications. Yet other example embodiments may comprise an article of manufacture that comprises a non-transitory tangible computer readable machine-accessible medium having instructions encoded thereon for enabling programmable hardware to cause a device (e.g. wireless communicator, UE, base station, etc.) to enable operation of multi-carrier communications. The device may include processors, memory, interfaces, and/or the like. Other example embodiments may comprise communication networks comprising devices such as base stations, wireless devices (or user equipment: UE), servers, switches, antennas, and/or the like.

[0125] The amount of data traffic carried over cellular networks is expected to increase for many years to come. The number of users/devices is increasing and each user/device accesses an increasing number and variety of services, e.g. video delivery, large files, images. This may require not only high capacity in the network, but also provisioning very high data rates to meet customers' expectations on interactivity and responsiveness. More spectrum may therefore be needed for cellular operators to meet the increasing demand. Considering user expectations of high data rates along with seamless mobility, it may be beneficial that more spectrum be made available for deploying macro cells as well as small cells for cellular systems.

[0126] Striving to meet the market demands, there has been increasing interest from operators in deploying some complementary access utilizing unlicensed spectrum to meet the traffic growth. This is exemplified by the large number of operator-deployed Wi-Fi networks and the 3GPP standardization of LTE/WLAN interworking solutions. This interest indicates that unlicensed spectrum, when present,

may be an effective complement to licensed spectrum for cellular operators to help addressing the traffic explosion in some scenarios, such as hotspot areas. LAA may offer an alternative for operators to make use of unlicensed spectrum while managing one radio network, thus offering new possibilities for optimizing the network's efficiency.

[0127] In an example embodiment, Listen-before-talk (clear channel assessment) may be implemented for transmission in an LAA cell. In a listen-before-talk (LBT) procedure, equipment may apply a clear channel assessment (CCA) check before using the channel. For example, the CCA may utilize at least energy detection to determine the presence or absence of other signals on a channel in order to determine if a channel is occupied or clear, respectively. For example, European and Japanese regulations mandate the usage of LBT in the unlicensed bands. Apart from regulatory requirements, carrier sensing via LBT may be one way for fair sharing of the unlicensed spectrum.

[0128] In an example embodiment, discontinuous transmission on an unlicensed carrier with limited maximum transmission duration may be enabled. Some of these functions may be supported by one or more signals to be transmitted from the beginning of a discontinuous LAA downlink transmission. Channel reservation may be enabled by the transmission of signals, by an LAA node, after gaining channel access via a successful LBT operation, so that other nodes that receive the transmitted signal with energy above a certain threshold sense the channel to be occupied. Functions that may need to be supported by one or more signals for LAA operation with discontinuous downlink transmission may include one or more of the following: detection of the LAA downlink transmission (including cell identification) by UEs, time & frequency synchronization of UEs, and/or the like.

[0129] In an example embodiment, a DL LAA design may employ subframe boundary alignment according to LTE-A carrier aggregation timing relationships across serving cells aggregated by CA. This may not imply that the eNB transmissions can start only at the subframe boundary. LAA may support transmitting PDSCH when not all OFDM symbols are available for transmission in a subframe according to LBT. Delivery of necessary control information for the PDSCH may also be supported.

[0130] An LBT procedure may be employed for fair and friendly coexistence of LAA with other operators and technologies operating in an unlicensed spectrum. LBT procedures on a node attempting to transmit on a carrier in an unlicensed spectrum may require the node to perform a clear channel assessment to determine if the channel is free for use. An LBT procedure may involve at least energy detection to determine if the channel is being used. For example, regulatory requirements in some regions, for example, in Europe, may specify an energy detection threshold such that if a node receives energy greater than this threshold, the node assumes that the channel is not free. While nodes may follow such regulatory requirements, a node may optionally use a lower threshold for energy detection than that specified by regulatory requirements. In an example, LAA may employ a mechanism to adaptively change the energy detection threshold. For example, LAA may employ a mechanism to adaptively lower the energy detection threshold from an upper bound. Adaptation mechanism(s) may not preclude

static or semi-static setting of the threshold. In an example a Category 4 LBT mechanism or other type of LBT mechanisms may be implemented.

[0131] Various example LBT mechanisms may be implemented. In an example, for some signals, in some implementation scenarios, in some situations, and/or in some frequencies, no LBT procedure may be performed by the transmitting entity. In an example, Category 2 (for example, LBT without random back-off) may be implemented. The duration of time that the channel is sensed to be idle before the transmitting entity transmits may be deterministic. In an example, Category 3 (for example, LBT with random back-off with a contention window of fixed size) may be implemented. The LBT procedure may have the following procedure as one of its components. The transmitting entity may draw a random number N within a contention window. The size of the contention window may be specified by the minimum and maximum value of N . The size of the contention window may be fixed. The random number N may be employed in the LBT procedure to determine the duration of time that the channel is sensed to be idle before the transmitting entity transmits on the channel. In an example, Category 4 (for example, LBT with random back-off with a contention window of variable size) may be implemented. The transmitting entity may draw a random number N within a contention window. The size of the contention window may be specified by a minimum and maximum value of N . The transmitting entity may vary the size of the contention window when drawing the random number N . The random number N may be employed in the LBT procedure to determine the duration of time that the channel is sensed to be idle before the transmitting entity transmits on the channel.

[0132] LAA may employ uplink LBT at the UE. The UL LBT scheme may be different from the DL LBT scheme (for example, by using different LBT mechanisms or parameters), since the LAA UL may be based on scheduled access which affects a UE's channel contention opportunities. Other considerations motivating a different UL LBT scheme include, but are not limited to, multiplexing of multiple UEs in a single subframe.

[0133] In an example, a DL transmission burst may be a continuous transmission from a DL transmitting node with no transmission immediately before or after from the same node on the same CC. A UL transmission burst from a UE perspective may be a continuous transmission from a UE with no transmission immediately before or after from the same UE on the same CC. In an example, a UL transmission burst may be defined from a UE perspective. In an example, a UL transmission burst may be defined from an eNB perspective. In an example, in case of an eNB operating DL+UL LAA over the same unlicensed carrier, DL transmission burst(s) and UL transmission burst(s) on LAA may be scheduled in a TDM manner over the same unlicensed carrier. For example, an instant in time may be part of a DL transmission burst or an UL transmission burst.

[0134] In an example embodiment, in an unlicensed cell, a downlink burst may be started in a subframe. When an eNB accesses the channel, the eNB may transmit for a duration of one or more subframes. The duration may depend on a maximum configured burst duration in an eNB, the data available for transmission, and/or eNB scheduling algorithm. FIG. 10 shows an example downlink burst in an unlicensed (e.g. licensed assisted access) cell. The maxi-

imum configured burst duration in the example embodiment may be configured in the eNB. An eNB may transmit the maximum configured burst duration to a UE employing an RRC configuration message.

[0135] The wireless device may receive from a base station at least one message (for example, an RRC) comprising configuration parameters of a plurality of cells. The plurality of cells may comprise at least one license cell and at least one unlicensed (for example, an LAA cell). The configuration parameters of a cell may, for example, comprise configuration parameters for physical channels, (for example, a ePDCCH, PDSCH, PUSCH, PUCCH and/or the like).

[0136] In an example embodiments, LTE transmission time may include frames, and a frame may include many subframes. The size of various time domain fields in the time domain may be expressed as a number of time units $T_s=1/(15000 \times 2048)$ seconds. Downlink, uplink and sidelink transmissions may be organized into radio frames with $T_f=307200 \times T_s=10$ ms duration.

[0137] In an example LTE implementation, at least three radio frame structures may be supported: Type 1, applicable to FDD, Type 2, applicable to TDD, Type 3, applicable to LAA secondary cell operation. LAA secondary cell operation applies to frame structure type 3.

[0138] Transmissions in multiple cells may be aggregated where one or more secondary cells may be used in addition to the primary cell. In case of multi-cell aggregation, different frame structures may be used in the different serving cells.

[0139] Frame structure type 1 may be applicable to both full duplex and half duplex FDD. A radio frame is $T_f=307200 \cdot T_s=10$ ms long and may comprise 20 slots of length $T_{slot}=15360 \cdot T_s=0.5$ ms numbered from 0 to 19. A subframe may include two consecutive slots where subframe i comprises of slots $2i$ and $2i+1$.

[0140] For FDD, 10 subframes are available for downlink transmission and 10 subframes are available for uplink transmissions in a 10 ms interval. Uplink and downlink transmissions are separated in the frequency domain. In half-duplex FDD operation, the UE may not transmit and receive at the same time while there may not be such restrictions in full-duplex FDD.

[0141] Frame structure type 2 may be applicable to TDD. A radio frame of length $T_f=307200 \cdot T_s=10$ ms may comprise of two half-frames of length $153600 \cdot T_s=5$ ms. A half-frame may comprise five subframes of length $30720 \cdot T_s=1$ ms. A subframe i may comprise two slots, $2i$ and $2i+1$, of length $T_{slot}=15360 \cdot T_s=0.5$ ms.

[0142] The uplink-downlink configuration in a cell may vary between frames and controls in which subframes uplink or downlink transmissions may take place in the current frame. The uplink-downlink configuration in the current frame is obtained via control signaling.

[0143] An example subframe in a radio frame, "may be a downlink subframe reserved for downlink transmissions, may be an uplink subframe reserved for uplink transmissions or may be a special subframe with the three fields DwPTS, GP and UpPTS. The length of DwPTS and UpPTS are subject to the total length of DwPTS, GP and UpPTS being equal to $30720 \cdot T_s=1$ ms.

[0144] Uplink-downlink configurations with both 5 ms and 10 ms downlink-to-uplink switch-point periodicity may be supported. In case of 5 ms downlink-to-uplink switch-

point periodicity, the special subframe may exist in both half-frames. In case of 10 ms downlink-to-uplink switch-point periodicity, the special subframe may exist in the first half-frame.

[0145] Subframes 0 and 5 and DwPTS may be reserved for downlink transmission. UpPTS and the subframe immediately following the special subframe may be reserved for uplink transmission.

[0146] In an example, in case multiple cells are aggregated, the UE may assume that the guard period of the special subframe in the cells using frame structure Type 2 have an overlap of at least $1456 \cdot T_s$.

[0147] In an example, in case multiple cells with different uplink-downlink configurations in the current radio frame are aggregated and the UE is not capable of simultaneous reception and transmission in the aggregated cells, the following constraints may apply. If the subframe in the primary cell is a downlink subframe, the UE may not transmit any signal or channel on a secondary cell in the same subframe. If the subframe in the primary cell is an uplink subframe, the UE may not be expected to receive any downlink transmissions on a secondary cell in the same subframe. If the subframe in the primary cell is a special subframe and the same subframe in a secondary cell is a downlink subframe, the UE may not be expected to receive PDSCH/EPDCCH/PMCH/PRS transmissions in the secondary cell in the same subframe, and the UE may not be expected to receive any other signals on the secondary cell in OFDM symbols that overlaps with the guard period or UpPTS in the primary cell.

[0148] Frame structure type 3 may be applicable to LAA secondary cell operation with normal cyclic prefix. A radio frame is $T_f = 307200 \cdot T_s = 10$ ms long and comprises of 20 slots of length $T_{slot} = 15360 \cdot T_s = 0.5$ ms, numbered from 0 to 19. A subframe may comprise as two consecutive slots where subframe i comprises slots $2i$ and $2i+1$.

[0149] The 10 subframes within a radio frame are available for downlink transmissions. Downlink transmissions occupy one or more consecutive subframes, starting anywhere within a subframe and ending with the last subframe either fully occupied or following one of the DwPTS durations. Subframes may be available for uplink transmission when LAA uplink is supported.

[0150] In an LAA cell, uplink transmission timing is advanced by N_{TA} as shown in FIG. 16. A UE advances its transmission timing based on TAC received from the eNB, e.g. to compensate for round-trip propagation delay. This may imply that from a UE transmitter uplink subframe timing starts and ends earlier than downlink subframes. A guard period is needed when downlink transmission ends and uplink transmission starts in a UE. The eNB may not be able to calculate the exact N_{TA} amount, since the UE may autonomously change the N_{TA} in some scenarios. A guard period may be required so that uplink and downlink transmission timings do not overlap in a TDD system. In addition, LBT period for a UE may create a transmission gap between downlink transmission and uplink transmission. FIG. 11 shows an example uplink and downlink timings in a UE.

[0151] In an example embodiment, the guard period/LBT may provide a transmission gap. Other UEs/nodes (e.g. Wifi nodes) may acquire the channel after downlink transmission ends, and during the transmission/LBT gap. This may not allow a UE to acquire the channel and transmit uplink

signals when the UE is granted an uplink resource after a downlink burst. Transmission of reservation signals by a UE may enable to reserve the channel and reduce the possibility of losing a channel.

[0152] In an LAA system, when an eNB transmits a full downlink subframe, the next available subframe for uplink transmission may be a partial uplink subframe due to transmission gap, NTA requirements, and/or LBT process. In an LAA system, when an eNB transmits an end partial downlink subframe, the next available subframe for uplink transmission may be a full or partial uplink subframe due to transmission gap, NTA requirements, and/or LBT.

[0153] In an example implementation, cells in a first group of multiple LAA cells may be aggregated and a UE may not be capable of simultaneous reception and transmission in the aggregated LAA cells. For example, the cells may be in the same band. For example, the cells may be in adjacent frequencies in the same band. This may be due to a software and/or hardware limitation in the wireless device.

[0154] Some or all of the cells in the first group of the multiple LAA cells may be capable of simultaneous reception and transmission with the PCell and/or other licensed cells. For example, an LAA cell in the first group may be able to transmit signals while receiving signals on a PCell. In this case, applying constraints to the UE on transmission and reception of signals on LAA based on the state of the PCell (downlink, uplink, or special subframe) seems to be an inefficient and sub-optimal solution.

[0155] In an example, a second group of multiple LAA cells different from the first group may be configured. The second group of multiple LAA cells may be aggregated and a UE may not be capable of simultaneous reception and transmission in the aggregated LAA cells of the second group. For example, the cells in the same cell group may be in the same band. For example, the cells may be adjacent in frequency in the same band.

[0156] A cell in the first group may transmit signals while a cell in the second group is receiving signals, and vice versa. For example, cells in the first group may be in a first band and the cells in the second group may be in a second band. For example, cells in the first group may employ a first transceiver and cells in the second group may employ a second transceiver. The example embodiments may separately apply to a first group and a second group.

[0157] In an example implementation, the cells in the first group may have their own limitations with respect to simultaneous reception and transmission in the aggregated cells of the first group. In an example implementation, the cells in the second group may have their own limitations with respect to simultaneous reception and transmission in the aggregated cells of the second group. Cells in different licensed bands may have their own constraints on simultaneous reception and transmission in the aggregated cells.

[0158] In an implementation, cells may be grouped according to their limitations on simultaneous reception and transmission in the aggregated cells.

[0159] In an example embodiment, a UE may not assume that LAA cells may follow the same uplink and downlink subframes as the PCell. A PCell may employ frame structure Type 1 or 2, while an LAA cell may employ frame structure Type 3. In an example embodiment, constraints are introduced for a UE and/or eNB for cells in a group to reduce the transmit and/or receive possibilities. This may reduce unnecessary signal processing in the UE and/or eNB. The

constraints may be employed by the UE and/or eNB to reduce battery power consumption in the UE and/or eNB. The constraints may be applicable to the cells within a cell group, for example, the cells in the licensed band, a first group of cells in an unlicensed band A, a second group of cells in an unlicensed band B, etc. Example embodiments improve LAA cell efficiency and reduces UE battery power consumption and reduces UE processing requirements.

[0160] In an example embodiment, cells may be grouped based on simultaneous reception and transmission in the aggregated cells in a group. A UE may not be capable of simultaneous reception and transmission in the aggregated cells within a cell group.

[0161] In an example embodiment, a UE may transmit an RRC message (e.g. UE capability message) to the eNB. The message may comprise one or more parameters indicating the UE capability with respect to the example cell grouping. For example, the one or more parameters may indicate certain frequency bands, in which cells are grouped within a cell group. For example, the one or more parameters may comprise a set of frequencies that are in a cell group. For example, the one or more parameters may be a transceiver parameter in the UE indicating the frequency bands in which cells may be grouped. For example, the one or more parameters may indicate a device category or certain capability that indicate the limitation on cell aggregation to the UE.

[0162] In an example, such an aggregation limitation in different cell groups may be a characteristic of the UE, and an eNB may not be informed about such limitation. In an example embodiment, the aggregation limitation may be pre-specified in both eNB and UE based on bands, cell frequencies, cell bandwidth, and/or other parameters.

[0163] In an example, an eNB may configure the cell grouping in the UE. An eNB may transmit one or more messages to the UE configuring cell grouping based on simultaneous reception and transmission capability in the aggregated cells within a cell group. For example, an eNB may transmit one or more RRC messages comprising cell indexes of a cell group (e.g. identified by a group index). The one or more RRC message may associate the cells with a group, e.g. using a cell group index.

[0164] In an example embodiment, a cell in a group may be considered a lead cell. A lead cell may be preconfigured by an RRC message. An RRC message may comprise one or more parameters, e.g. a cell index, of a cell in a cell group. In an example, an RRC may comprise one or more configuration parameters for an SCell that implicitly or explicitly indicates that the cell is a lead cell in a group. In an example, the lead cell may be determined according to a predefined rule, for example the cell with a lowest cell index, and/or the like. The predefined rule may be configured in a UE and/or an eNB.

[0165] In an example embodiment, the lead cell may be identified by a UE on a subframe by subframe basis. In an example embodiment, there is no need to select a lead cell, and a collective constraint may be applied to the cells in a group at any moment. In an example, the cell that has certain characteristics at a moment (e.g. eNB is transmitting, UE is transmitting) may determine the status of other cells. In an example, a lead cell may be any cell in a cell group.

[0166] In an example implementation, when a UE is not capable of receiving downlink signals in a group at certain time, the UE may not decode downlink signals of cells of a group at that certain time. The UE may not blind decode the

downlink cell and/or search for downlink signals. The UE may not expect to receive and monitor downlink signals such as synchronization signals, DRS, control channels (PCFICH, PDCCH, ePDCCH, PDSCH, and/or CRS, etc). This may reduce the battery power consumption in the UE, since the UE may not decode the receive signals. For example, the UE may turn off the receiver on one or more cells in a group. The UE may selectively monitor downlink signals/channels of a subframe based on downlink and uplink transmissions in another cell in the group.

[0167] An example scenario is described below. The lead cell may be any one of the activated cells within a group.

[0168] Example status of a lead cell in a group: downlink transmission, then example UE capability in other cells of the group may be one or more of the following: Can receive downlink signals; Cannot transmit uplink signals; Can perform LBT for uplink transmission; UE may be during a guard period (e.g. DL to UL transition period).

[0169] Example status of a lead cell in a group: idle (no DL/UL transmission), then Example UE capability in other cells of the group may be one or more of the following: Can receive downlink signals; Can transmit uplink signals; Can perform LBT for uplink transmission; UE may be during a guard period (e.g. DL to UL transition period, or UL to DL transition period).

[0170] Example status of a lead cell in a group: Uplink transmission, then Example UE capability in other cells of the group may be one or more of the following: Cannot receive downlink signals; Can transmit uplink signals; Can perform LBT for uplink transmission (e.g. with a different threshold); UE may be during a guard period (e.g. UL to DL transition period).

[0171] In an example, the lead cell may be any one of the activated cells within a group. In the following examples, the state of a full subframe is described.

[0172] Status of a lead cell during the full subframe n: downlink transmission, then UE capability in other cells of the group may be one or more of the following: Subframe n can be downlink; Subframe n can be an ending (partial) uplink subframe (e.g. depending on configuration); sub-frame n+1 can be a beginning (partial) uplink subframe (e.g. depending on configuration); Can perform LBT for uplink transmission for a beginning (partial) uplink subframe in subframe n+1 (e.g. depending on configuration); UE may be during a guard period (e.g. DL to UL transition period).

[0173] Status of a lead cell during the full subframe n: idle period, then UE capability in other cells of the group may be one or more of the following: Can receive downlink signals; Can transmit uplink signals; Can perform LBT for uplink transmission; UE may be during a guard period (e.g. DL to UL transition period, or UL to DL transition period).

[0174] Status of a lead cell during the full subframe n: uplink transmission, then UE capability in other cells of the group may be one or more of the following: Can receive downlink reservation signals during an end period of sub-frame n, can receive downlink beginning partial subframe (e.g. depending on configuration, and/or N_TA); Can transmit uplink signals; Can perform LBT for uplink transmission (e.g. with a different threshold); UE may be during the guard period (e.g. UL to DL transition period).

[0175] For example, when subframe n is a full downlink subframe, a UE may receive downlink signals in other cells of the cell group in subframe n. Depending on implementation, subframe n may be capable of being an ending

(partial) uplink subframe (e.g. depend on TA values and/or whether implementation of ending partial uplink subframe is allowed). Subframe n+1 can be a beginning (partial) uplink subframe (e.g. depend on TA values and/or whether implementation of beginning partial uplink subframe is allowed). For example, in an implementation the second slot of subframe n+1 may be employed for uplink transmission. In an example, if a UE transmitting signals in full subframe k in a cell in response to a grant, the UE may not monitor downlink control channels in subframe k on other cells.

[0176] In an example embodiment, a detected downlink burst may determine the status of the cells in a group. For example, when a UE starts receiving a downlink burst in a subframe, the UE may assume that the cells in the group are in downlink transmission mode, until the last downlink transmission burst on the last cell ends. The UE may not transmit any signals until the downlink transmission from the eNB continues. After the UE detects the last downlink transmission on one or the cells, the UE may start LBT for uplink transmission (e.g. if the UE has an uplink grant, or needs to transmit an SRS, PRACH, etc).

[0177] In an example, when a UE starts transmission of an uplink burst in a subframe, the UE may assume that the cells are in uplink transmission mode, until the last uplink TB is transmitted on a last cell. During the uplink transmission on a cell, the UE may not monitor downlink signals on other cells until uplink transmission on a last cell ends. For example, the UE may not monitor downlink control channel, synch signal, DRS and other downlink signals on a cell when the UE is transmitting on another cell in the group.

[0178] When a subframe is a partial subframe, the status of other cells in the subframe and subsequent subframes may depend on the duration of the transmission during the partial subframe and whether the partial subframe is a beginning subframe or an ending subframe. Some example scenarios are described below.

[0179] Status of a lead cell during a partial subframe n: downlink end partial transmission, then UE capability in other cells of the group may be one or more of the following: Subframe n can be downlink, Subframe n can be an ending (partial) uplink subframe (e.g. depending on configuration, and/or N_TA), subframe n+1 can be a beginning (partial or full) uplink subframe (e.g. depending on partial subframe length, configuration, and/or N_TA), Can perform LBT for uplink transmission for a beginning (partial or full) uplink subframe (e.g. depending on partial subframe length, configuration, and/or N_TA), UE may be during a guard period (e.g. DL to UL transition period).

[0180] Status of a lead cell during a partial subframe n: downlink beginning partial transmission, then UE capability in other cells of the group may be one or more of the following: Subframe n can be downlink; Subframe n can be an ending (partial) uplink subframe, subframe n+1 can be a beginning (partial) uplink subframe or no uplink (e.g. depending on partial subframe length, configuration, and/or N_TA).

[0181] In an example embodiment, similar constraints may be applied to eNB. This process may reduce battery power consumption in the eNB. Groupings may provide scheduling constraints in the eNB for downlink transmission and uplink reception similar to the constraints in the UE.

[0182] Some example embodiments are shown in FIGS. 12 to 15. In example figures, a limited number of downlink

bursts and uplink bursts are shown. In an example, an uplink burst or downlink burst may be one or more transmission bursts.

[0183] In an example embodiment as shown in FIG. 12, downlink transmission may start at the same or different starting time in different cells (e.g. depending on scheduling, LBT, configuration, etc.). For example, LBT may detect an interference in cell2 until the start of DL2 burst, and LBT in cell1 indicate a clear channel earlier. For example, eNB may start scheduling downlink information on cell2 later than cell1. The eNB may transmit downlink signals and UE may receive downlink signals until the last downlink burst in a cell is ended, e.g. DL3 (the UE is in downlink mode). Then the UE may start uplink transmission, if UE is granted uplink resources. In an example, the UE may transmit uplink until the last uplink burst is ended, e.g. UL3 (the UE is in uplink mode). The UE may not transmit any signal when it is in downlink mode. The UE may not receive any signal and may not decode downlink control signals when it is in uplink mode. FIG. 12 is an example, in some scenarios, some of the cells may not be scheduled for downlink or uplink transmission. For example, consider FIG. 12 and when DL2 or UL1 may not be transmitted.

[0184] Another example is shown in FIG. 13. FIG. 13 illustrates a scenario, wherein LAA cell1 transmits two downlink bursts. In FIG. 13, LAA cell 1 is the cell with a downlink that last longer.

[0185] In an example embodiment as shown in FIG. 14, downlink bursts on one or more cells may end substantially at the same time, and/or in the same subframe. In an example the downlink burst that started first may determine when the COT is ended. In an example, this cell may be the lead cell. Other downlink transmission bursts may start later (DL2 and DL3), but may end at the same time as DL1 or earlier than DL1 (e.g. when there is no data to be transmitted on DL3, DL3 may end earlier). In an example, the same concept may apply to uplink transmissions. The uplink burst that started first may determine the beginning of an uplink burst. The COT may be determined from the time that UL1 has started and may end when UL2/UL3 is ended.

[0186] In an example embodiment as shown in FIG. 15, downlink and/or uplink transmission on multiple cells may start at the same time. For example, the eNB may start downlink transmission on multiple cells, when LBT clears on one or more cells. For example, in the figures DL1, DL2, and DL3 started at the same time. In an example, if LBT of a cell does not indicate clear channel, the eNB may not transmit a downlink signal on the cell. In an example, if LBT of a cell does not indicate a clear channel, the eNB may defer transmission on other cell for certain period. In an example, eNB may decide on whether it should defer transmission on cells or transmit on some of the cells and not to transmit on some other cells. The downlink bursts may end at different times, depending on scheduling method and available downlink data. The same may apply to uplink. For example, UL1 and UL3 started at the same time, but may end at different times. The eNB may not have scheduled data for cell2 in the uplink, or LBT in the UE may not have indicated a clear channel.

[0187] In an example embodiment, a cell may be configured or selected as a lead cell, and other cells in a group may follow the status of the lead cell. In an example embodiment, one or more RRC message may comprise one or more parameters indicating the configuration parameters of down-

link and uplink transmission parameter and may determine one or more modes as described above is operated by a UE and/or eNB.

[0188] In an example embodiment, the examples in FIG. 12 to FIG. 15 may be extended to illustrate the operations of an eNB. For example, an eNB may not decode signals from a UE, when it is in a downlink transmission mode. For example, an eNB may not transmit any signals to any UE, when it is in the receive mode. The constraints described in the example embodiments may be extended to the operations on an eNB. The constraints may be employed by an eNB scheduler to schedule uplink and downlink TBs. For example, an eNB may not schedule uplink TB on cell1 and downlink TB on cell1.

[0189] Example embodiments may be deployed to resolve conflicting situations in a UE. For example, when a UE is scheduled to transmit a TB in subframe n , but the UE receives indication of downlink eNB signals in subframe $n-1$ and/or subframe n , the UE may decide to ignore the downlink signal or transmit the uplink grant. In an example embodiment, the UE may consider that downlink transmission from an eNB may have priority over uplink transmission from the UE. For example, when the UE detects downlink transmission from an eNB in subframe n , the UE may consider that the subframe n is a downlink subframe. The UE may ignore conflicting uplink grants and ignore a scheduled uplink transmission (e.g. SRS, data, control, PRACH, etc). In an example, when eNB has already started uplink transmission, it may not be able to detect downlink signals transmitted from the UE during its uplink transmission in the cell group.

[0190] In an example embodiment, an eNB may schedule downlink and uplink TBs according to the constraints described in the embodiment. The UE may transmit or receive signals according to the (e)PDCCH scheduling grants received from the eNB. The UE and/or eNB may employ the constraints described in the example embodiment to reduce the required processing of signals and reduce battery power consumption.

[0191] A UE and/or eNB may configure a timer and/or a counter tracking the continuous transmission in a burst. A UE and/or eNB may start the timer when it starts transmission and/or reception. This may allow the UE and/or an eNB when an uplink and/or downlink transmission burst may end. The UE and/or eNB may subsequently base its downlink and/or uplink processing based on the value in the timer. An eNB and/or UE may be allowed to continuously transmit up to a maximum duration. In an example embodiment, an eNB may transmit an RRC message to a UE comprising the value of the timer/counter.

[0192] According to various embodiments, a device such as, for example, a wireless device, a base station and/or the like, may comprise one or more processors and memory. The memory may store instructions that, when executed by the one or more processors, cause the device to perform a series of actions. Embodiments of example actions are illustrated in the accompanying figures and specification.

[0193] Frame structure type 2 may be applicable to TDD. A radio frame of length $T_f=307200 \cdot T_s=10$ ms may comprise of two half-frames of length $153600 \cdot T_s=5$ ms. A half-frame comprises of five subframes of length $30720 \cdot T_s=1$ ms. A subframe i is defined as two slots, $2i$ and $2i+1$, of length

$T_{slot}=15360 \cdot T_s=0.5$ ms. Subframe i in frame n_f has an absolute subframe number $n_{sf}^{ab}=1+i$ where n_f is the system frame number.

[0194] The uplink-downlink configuration in a cell may vary between frames and controls in which subframes uplink or downlink transmissions may take place in the current frame.

[0195] The supported TDD uplink-downlink configurations are pre-defined in LTE standards, for a subframe in a radio frame, “D” denotes a downlink subframe reserved for downlink transmissions, “U” denotes an uplink subframe reserved for uplink transmissions and “S” denotes a special subframe with the three fields DwPTS, GP and UpPTS. The total length of DwPTS, GP and UpPTS being equal to $30720 \cdot T_s=1$ ms where X is the number of additional SC-FDMA symbols in UpPTS provided by the higher layer parameter $srs\text{-}UpPts\text{-}Add$ if configured otherwise X is equal to 0. The UE is not expected to be configured with 2 additional UpPTS SC-FDMA symbols for special subframe configurations {3, 4, 7, 8} for normal cyclic prefix in downlink and special subframe configurations {2, 3, 5, 6} for extended cyclic prefix in downlink and 4 additional UpPTS SC-FDMA symbols for special subframe configurations {1 2, 3, 4, 6, 7, 8} for normal cyclic prefix in downlink and special subframe configurations {1, 2, 3, 5, 6} for extended cyclic prefix in downlink.

[0196] In frame structure 2 (TDD), uplink-downlink configurations with both 5 ms and 10 ms downlink-to-uplink switch-point periodicity are supported. In case of 5 ms downlink-to-uplink switch-point periodicity, the special subframe may exist in both half-frames. In case of 10 ms downlink-to-uplink switch-point periodicity, the special subframe may exist in the first half-frame.

[0197] In frame structure 2, subframes 0 and 5 and DwPTS may be reserved for downlink transmission. UpPTS and the subframe immediately following the special subframe may be reserved for uplink transmission. In case multiple cells are aggregated, the UE may assume that the guard period of the special subframe in the cells using frame structure type 2 have an overlap of at least $1456 \cdot T_s$. In an example implementation, the UE is not expected to be configured with 2 additional UpPTS SC-FDMA symbols for special subframe configurations {3, 4, 7, 8} for normal cyclic prefix in downlink and 4 additional UpPTS SC-FDMA symbols for special subframe configurations {1 2, 3, 4, 6, 7, 8} for normal cyclic prefix in downlink.

[0198] An RRC may comprise parameter $srs\text{-}UpPts\text{-}Add\text{-}r13$: ENUMERATED {sym2, sym4}. $srs\text{-}UpPts\text{-}Add$ may apply for TDD. If E-UTRAN configures both soundingRS-UL-ConfigDedicatedUpPtsExt and soundingRS-UL-ConfigDedicatedAperiodicUpPtsExt, $srs\text{-}UpPts\text{-}Add$ in both fields may be set to the same value.

[0199] In a frame structure 2 (TDD), in an example embodiment, an RRC parameter may determine the length of additional UpPTS symbols. The number of additional UpPTS symbols may be indicated to the UE with the RRC parameter with two states: {2, 4}. The number of total UpPTS SC-FDMA symbols may not exceed 6 in a special subframe. The number of DwPTS symbols may be the number of DwPTS symbols in special subframe configuration in SIB1. For trigger types 0 and 1, a set of RRC parameter values for additional UpPTS may be configured from the legacy SRS configurations.

[0200] In a frame structure 2 (TDD), tdd-config IE in SIB1 may specify the TDD specific physical channel configurations. E-UTRAN may set this field to the same value for instances of SIB1 message that are broadcasted within the same cell. In an example LTE implementation, tdd-config may not change over time. The IE TDD-Config may be defined as TDD-Config::=SEQUENCE {subframeAssignment: ENUMERATED {sa0, sa1, sa2, sa3, sa4, sa5, sa6}, specialSubframePatterns: ENUMERATED {ssp0, ssp1, ssp2, ssp3, ssp4, ssp5, ssp6, ssp7, ssp8}}. In release 11, a new format is defined for TDD-Config-v1130 IE as TDD-Config-v1130::=SEQUENCE {specialSubframePatterns-v1130:ENUMERATED {ssp7,ssp9}}. In release 12, a new format is defined for TDD-ConfigSL-r12 as TDD-ConfigSL-r12::=SEQUENCE {subframeAssignmentSL-r12:ENUMERATED {none, sa0, sa1, sa2, sa3, sa4, sa5, sa6}}.

[0201] Frame structure type 3 may be applicable to an LAA cell operation with normal cyclic prefix. A radio frame is $T_f=307200 \cdot T_s=10$ ms long and comprises of 20 slots of length $T_{slot}=15360 \cdot T_s=0.5$ ms, numbered from 0 to 19. A subframe is defined as two consecutive slots where subframe i comprises of slots $2i$ and $2i+1$.

[0202] The 10 subframes within a radio frame are available for downlink transmissions. Downlink transmissions may occupy one or more consecutive subframes, starting anywhere within a subframe and ending with the last subframe either fully occupied or following one of the DwPTS durations in FIG. 19.

[0203] UL transmissions on an LAA cell may be supported in release 14 and beyond. If the legacy special configuration is adopted for a beginning partial uplink subframe, it may result in example configurations shown in FIG. 19.

[0204] In legacy special subframe (Frame structure 2), a UE is not expected to be configured with 2 additional UpPTS SC-FDMA symbols for special subframe configurations {3, 4, 7, 8} for normal cyclic prefix in downlink and 4 additional UpPTS SC-FDMA symbols for special subframe configurations {1, 2, 3, 4, 6, 7, 8} for normal cyclic prefix in downlink. In the current LTE-Advanced systems, an RRC may comprise parameter srs-UpPtsAdd-r13: ENUMERATED {sym2, sym4}. srs-UpPtsAdd may apply for TDD. In TDD, if E-UTRAN configures both soundingRS-UL-ConfigDedicatedUpPtsExt and soundingRS-UL-ConfigDedicatedAperiodicUpPtsExt, srs-UpPtsAdd in both fields may be set to the same value.

[0205] If additional UpPTS symbols are configured for SRS, then a new ksrs table may be used to derive SRS transmission instance in extended UpPTS. In an example embodiment, for both trigger type 0 and 1, if a new set of RRC parameter values for additional UpPTS (e.g., SoundingRS-UL-ConfigDedicated-extendedUpPTS, SoundingRS-UL-ConfigDedicatedAperiodic-extendedUpPTS) is configured, the SRS parameters in a new set of RRC parameter may be used for UE to transmit SRS in extended UpPTS resource, otherwise, the legacy SRS parameters (e.g., SoundingRS-UL-ConfigDedicated, SoundingRS-UL-ConfigDedicatedAperiodic) may be used for UE to transmit SRS in legacy SRS resource. In an example, the parameter srs-UpPtsAdd may be separately configured for SRS trigger type 0 and trigger 1. A new ksrs table for trigger type 0 and type 1 may be based on whether the corresponding srs-UpPtsAdd is configured.

[0206] In an example embodiment, in an LAA cell, a UE may detect the size of an ending DL partial subframe by

decoding a common PDCCH DCI on the downlink subframe. DCI format 1C may indicate ending partial downlink subframe format. Subframe configuration for LAA may employ 4 bits. Reserved information bits may be added until the size is equal to that of format 1C used for very compact scheduling of one PDSCH codeword

[0207] In an example, if the UE detects common PDCCH DCI referring to subframe n in subframes $n-1$ or n , the UE may assume the number of OFDM symbols in subframe n according to the detected DCI. In an example, if the UE does not detect common PDCCH DCI in subframe n and the UE does not detect common PDCCH DCI in subframe $n-1$, the UE is not required to use the subframe n for updating the CSI measurement. In an example, a field in the DCI indicates the length of the subframe. Example values of the field and the corresponding indication is the following. 0: Next subframe is 3 OFDM symbols, 1: Next subframe is 6 OFDM symbols, 2: Next subframe is 9 OFDM symbols, 3: Next subframe is 10 OFDM symbols, 4: Next subframe is 11 OFDM symbols, 5: Next subframe is 12 OFDM symbols, 6: Next subframe is full (14 Symbols), 7: Current subframe is partial 3 OFDM symbols, 8: Current subframe is partial 6 OFDM symbols, 9: Current subframe is partial 9 OFDM symbols, 10: Current subframe is partial 10 OFDM symbols, 11: Current subframe is partial 11 OFDM symbols, 12: Current subframe is partial 12 OFDM symbols, 13: Current subframe is full (14 Symbols) and end of transmission, 14: Reserved, and 15: Reserved.

[0208] In an example, DCI format 1C is used to indicate this LAA common signalling. If the end subframe is partial subframe, then the end partial subframe configuration of a DL transmission burst is indicated to the UE in the end subframe and the previous subframe. The UE may expect that the information signalled in both the above subframes is consistent. In an example implementation, if the UE receives an indication of an end partial subframe in the current subframe but does not receive this signalling in the previous subframe, then the UE is not required to further process the subframe. If the end subframe is a full subframe, then such signalling may or may not be present. In an example DL transmission burst, an end partial subframe may not immediately follow an initial partial subframe.

[0209] There is a need to implement a mechanism for a partial beginning uplink subframe after a partial and/or full ending downlink subframe. Current UpPTS mechanism and RRC configuration of variable X can be implemented to configure a partial uplink subframe in an LAA cell. Implementation of legacy mechanism and using current UpPTS mechanism may reduce uplink channel access and/or resource efficiency. The larger the gap period, the higher is the probability that another node (e.g. another LTE and/or WiFi node) obtains channel access before the UE does (this may block the UEs access to channel for uplink transmission). In legacy LTE systems, the variable X for determining UpPTS period is semi-statically configured employing one or more information element in one or more RRC messages transmitted by an eNB to the UE. In a legacy special subframe, a UE may not be expected to be configured with 2 additional UpPTS SC-FDMA symbols for special subframe configurations {3, 4, 7, 8} for normal cyclic prefix in downlink and 4 additional UpPTS SC-FDMA symbols for special subframe configurations {1, 2, 3, 4, 6, 7, 8} for normal cyclic prefix in downlink.

[0210] Adopting legacy formats and configuration employed in legacy special subframe may reduce network efficiency and channel access. Some example embodiments disclose mechanisms for transition from downlink to uplink transmission in an LAA cell in a UE.

[0211] Subframes may be available for uplink transmission when LAA uplink is supported. In an LAA cell, uplink transmission timing is advanced by NTA (NTA in terms of T_s or equally called TA period) as shown in example FIG. 16. A UE advances its transmission timing based on TAC received from the eNB, e.g. to compensate for round-trip propagation delay. This may imply that from a UE transmitter uplink subframe timing starts and ends earlier than downlink subframes. A guard period is needed when downlink transmission ends and uplink transmission starts in a UE. The eNB may not be able to determine the exact NTA amount, since the UE may autonomously change the NTA in some scenarios. A guard period may be required so that uplink and downlink transmission timings do not overlap in a TDD system. In addition, LBT period for a UE may create a transmission gap between downlink transmission and uplink transmission. FIG. 11 shows an example uplink and downlink timings in a UE.

[0212] In an example embodiment, the downlink/uplink switching time, guard period, and/or LBT may provide a transmission gap. Other UEs/nodes (e.g. Wifi nodes) may acquire the channel after downlink transmission ends, and during the gap. This may not allow a UE to acquire the channel and transmit uplink signals when the UE is granted an uplink resource after a downlink burst. In an example, transmission of reservation signals by a UE may enable to reserve the channel and reduce the possibility of losing a channel. A reservation signal may be at least one pre-defined signal, e.g., reference signal, SRS, RACH, extension of cyclic prefix and/or the like.

[0213] In an LAA system, when an eNB transmits a full downlink subframe, the next available subframe for uplink transmission may be a partial uplink subframe due to the gap (e.g. depending on DL_UL_switching time, NTA requirements, and/or LBT process). In an LAA system, when an eNB transmits an end partial downlink subframe, the next available subframe for uplink transmission may be a full or partial uplink subframe due to transmission gap (e.g. including DL_UL_switching time, NTA requirements, and/or LBT process).

[0214] Uplink transmissions may start after an ending DL subframe. In an example, a DL subframe may end at DL symbol s of the DL subframe n . Uplink subframe may start at least after $DL_UL_Interval=TA+DL_UL_Switching+LBT_duration$ of the end of the UL symbol s of the corresponding UL subframe n (in terms of uplink subframe timing). In an example, when $DL_UL_Interval$ is 2 symbols, and DL subframe ends at DL symbol 8 (9 symbol duration) of subframe n , then uplink transmission may start at earliest in UL symbol 11 and may last for 3 symbols in subframe n (assuming normal cyclic prefix and 14 symbols in a subframe). In an example, when $DL_UL_Interval$ is 1 symbols, and DL subframe n is a full subframe, then uplink transmission may start at UL symbol 1 and last for 13 symbols in subframe $n+1$ (assuming normal cyclic prefix). UL symbol timing may be TA in advance of DL symbol timing.

[0215] In an example, TA may depend on propagation delay and may range up to tens of micro seconds depending on the UE distance to the eNB transceiver. In an example,

DL_UL_switching may depend on transceiver hardware limitations, and may be in range of micro-seconds or less, e.g. DL_UL_switching may be considered zero, then a gap duration (or a starting symbol) may be $DL_UL_Interval=TA+LBT_duration$. In an example, LBT period may be in the range of tens of micro seconds, for example, 25 usec, or one LTE symbol. In an example, a gap duration (or a starting symbol) may be $DL_UL_Interval=TA+25$ usec. In an example, a gap duration (or a starting symbol) may be $DL_UL_Interval=25$ usec, when TA is not considered (e.g. TA equal or close to zero). In an example, a gap duration (or a starting symbol) may be $DL_UL_Interval=1$ symbol. Symbol 0 of uplink subframe may be employed for TA, DL_UL_switching and/or LBT_period. In an example, a UE may transmit after downlink transmission burst without performing LBT if the regulatory rules and UE/eNB implementation permit such transmission. In an example, a gap duration (or a starting symbol) may be $DL_UL_Interval=0$. In an example, a UE may be required to perform LBT for a duration of 25 usec (e.g. LBT cat-2) before starting uplink transmission.

[0216] In an example embodiment, a starting symbol of uplink subframe $n+1$ may be signalled by a common DCI or dedicated DCI. For example, a base station may transmit a common DCI on an LAA cell to indicate a starting symbol and/or time of uplink subframe $n+1$. For example, a base station may transmit a dedicated DCI (e.g. uplink grant DCI) via an LAA cell or the cell scheduling the LAA cell. The dedicated DCI may indicate the starting symbol and/or time of the PUSCH. A base station may transmit to a wireless device an uplink grant DCI comprising a field indicating uplink resources for an uplink subframe of the LAA cell, and a field indicating a first starting position in a plurality of starting positions in the uplink subframe. For example, a dedicated DCI transmitted on an LAA cell or the cell scheduling the LAA cell may indicate a starting symbol of an uplink subframe. In an example, a field in uplink grant DCI may indicate a value indicating a starting symbol and/or time ($DL_UL_Interval$). The DCI may be transmitted in one or more subframes prior to the subframe including a starting symbol and/or time ($DL_UL_Interval$). In an example, the dedicated DCI may comprise a DCI field indicating starting symbol and/or time of subframe $n+1$. The DCI field may comprise 2 bits indicating one of values e.g. 0, 1, 2, 3 indicating one of the four states of starting symbol and/or time ($DL_UL_Interval$). In an example, $DL_UL_Interval$ may be equal to $TA+25$ usec, $DL_UL_Interval$ may be equal to 1 symbol, $DL_UL_Interval$ may be equal to 25 usec, or $DL_UL_Interval$ may be equal to 0.

[0217] FIG. 18 shows a first example for a gap period of 1 symbol and a second example for a gap period of $TA+25$ usec. In an example, a UE may be required to perform LBT for a duration of one symbol (e.g. LBT cat-4) before starting uplink transmission. Other LBT durations and processes may be defined for uplink transmission. The wireless device may construct one or more transport blocks employing the dedicated DCI. The wireless device may transmit the one or more transport blocks in the uplink resources starting from the starting position of the uplink subframe. In an example embodiment, DL end subframe before the uplink subframe may be a downlink partial subframe or a downlink full subframe. The size of partial uplink subframe $n+1$, may be 14 minus a gap period. For example, when the gap period is 1, the size of the partial uplink subframe may be 13.

[0218] In an example, when an ending DL subframe is a downlink partial subframe, uplink subframe may employ an uplink partial subframe configuration (e.g. depending on ending DL partial subframe duration). A gap period may be defined (e.g. in an eNB). The gap period may be required to provide an interval for at least $(DL_UL_switch+TA+LBT_period)$. The size of ending DL partial subframe may be downlink burst specific. For example, two downlink bursts transmitted by a cell may have different ending DL partial subframe sizes depending on when the downlink burst started and/or the MCOT duration in downlink. FIG. 17 shows examples of DL and UL transmission timings in a UE. In an example, TA may be 5 micro-seconds, LBT period may be 1 symbol or 25 micro-seconds, DL_UL_switch may be 3 micro-seconds or less, a gap may be two symbols. Gap may be larger than or equal to $(DL_UL_switch+TA+LBT_period)$. In an example, no signal may be transmitted in: gap period- $(DL_UL_switch+TA+LBT_period)$. In an example, a reservation signal may be transmitted in this period. Time duration presented here are for example only, and other durations may be implemented (e.g. a different gap period, a different LBT period, and/or a different DL_UL_switch etc). In order to have an efficient gap period, gap period may be configured to be equal or larger than $(DL_UL_switch+TA+LBT_period)$. In an example, reservation signals may be transmitted, gap period may be equal or larger than $(DL_UL_switch+TA+LBT_period+reservation_signal_period)$. In an example, when a one symbol LBT is required for uplink signal transmission, the gap period should be greater than one symbol, e.g. 2 or 3 symbols.

[0219] In an example embodiment, the duration of partial ending uplink subframe may be burst specific. For example, the duration of partial ending uplink subframe may depend on the duration of the downlink ending subframe, and/or other configuration parameters. UpPTS period may be employed for transmission of SRS and/or random access preamble. In an example, other signals may be transmitted during the UpPTS.

[0220] In an example embodiment, a gap period may be pre-specified and pre-determined. Gap period may impose some limitations on TA (and as a result cell radius), and/or LBT period. Pre-configuring a gap period may, for example, limit the cell radius. In an example, LAA cells may be employed for small cells and may not be expected to operate as large cells. For example, a fixed gap period of one symbol may be defined and implemented. In an example, a fixed gap period of two symbols may be implemented. In an example, a gap period of k micro seconds may be defined, wherein k is predefined, e.g. 50 micro-seconds, etc.

[0221] In an example embodiment, a gap period may be configured employing an RRC parameter. Such configuration may provide flexibility in configuring the gap period (and UpPTS period) in an LAA cell. Different bursts may employ the same gap period until RRC configuration parameter changes. For example, an RRC message may comprise configuration parameters of an LAA cell comprising one or more parameters indicating the duration of a gap period, e.g. 1 symbol. The gap period (e.g. in terms of a number of gap symbols) may be indicated to the UE with the RRC parameter with two states (1 bit), e.g., {1, 2}, or four states (2 bits), e.g. {1, 2, 3, 4}. Other examples may be provided. In an example, the parameter may be a common parameter and may be configured the same value for UEs communicating employing the LAA cell. For example, the gap period may

be transmitted in a SIB message. In an example embodiment, the values configured by RRC may be applicable to some DL partial subframe durations. In an example, multiple allowable gap periods may be configured. When a first LBT attempt fails, a UE may perform LBT employing a second gap period.

[0222] In an example embodiment, a gap period may be signalled by a common DCI or a dedicated DCI. For example, a common DCI transmitted on an LAA cell or PCell may indicate the size of the gap period. For example, a dedicated DCI transmitted on an LAA cell or the cell scheduling the LAA cell may indicate the size of the gap period (e.g. in uplink grant DCI). The DCI may be transmitted in the same and/or one or more subframes prior to the subframe including the gap period. In an example, DCI format 1C may be used, e.g. employing a predefined RNTI (e.g. the same DCI that carries the size of the partial ending DL subframe). Such configuration may provide flexibility in configuring the gap period (and UpPTS period) in an LAA cell for a given burst. Different bursts may employ different gap periods depending on the DCI parameter. For example, a DCI may comprise one or more parameters indicating the duration of a gap period, e.g. 1 symbol. The gap period (e.g. in terms of a number of gap symbols) may be indicated to the UE with a DCI field with two states (1 bit), e.g., {1, 2}, or four states (2 bits), e.g. {1, 2, 3, 4}. Other examples may be provided. In an example embodiment, the values transmitted by DCI may be applicable to some DL partial subframe durations. In an example, multiple allowable gap periods may be configured. When a first LBT attempt fails, a UE may perform LBT employing a second gap period.

[0223] In an example embodiment, a value of X may be signalled by a common DCI or dedicated DCI. For example, a common DCI transmitted on an LAA cell or PCell may indicate a value of X. For example, a dedicated DCI transmitted on an LAA cell or the cell scheduling the LAA cell may indicate a value of X (and e.g. using a special subframe configuration in the table above). In an example, a field in uplink grant DCI may indicate a value indicating X. The DCI may be transmitted in the same and/or one or more subframes prior to the subframe including the gap period. In an example, DCI format 1C may be used, e.g. employing a predefined RNTI (e.g. the same DCI that carries the size of the partial ending DL subframe). Such configuration may provide flexibility in configuring the gap period (and UpPTS period) in an LAA cell for a given burst. Different bursts may employ different gap periods (and UpPTS periods) depending on the DCI parameter. For example, a DCI may comprise one or more parameters indicating a value of X, e.g. 1 symbol. A value of X (e.g. in terms of a number of symbols) may be indicated to the UE with a DCI field with two states (1 bit), e.g., {1, 2}, or four states (2 bits), e.g. {1, 2, 3, 4}. Other examples may be provided. In an example embodiment, the values transmitted by DCI may be applicable to some DL partial subframe durations. In an example, multiple allowable X values may be configured. When a first LBT attempt fails, a UE may perform LBT employing a second X value.

[0224] In an example embodiment, a starting symbol of (partial) beginning uplink subframe may be signalled by a common DCI or dedicated DCI. For example, a common DCI transmitted on an LAA cell may indicate a starting symbol of uplink subframe (e.g. UpPTS). For example, a dedicated DCI transmitted on an LAA cell or the cell

scheduling the LAA cell may indicate a starting symbol of uplink subframe (e.g. using a special subframe configuration). In an example, a field in uplink grant DCI may indicate a value indicating a starting symbol. The DCI may be transmitted in the same and/or one or more subframes prior to the subframe including the gap period. In an example, DCI format 1C may be used, e.g. employing a predefined RNTI (e.g. the same DCI that carries the size of the partial ending DL subframe). Such configuration may provide flexibility in configuring a starting symbol (and gap period, and UpPTS period) in an LAA cell for a given burst. Different bursts may employ different gap periods depending on the DCI parameter. For example, a DCI may comprise one or more parameters indicating a starting symbol of UpPTS, e.g. symbol 8. A starting symbol of UpPTS (e.g. in terms of symbol number) may be indicated to the UE with a DCI field with two states (1 bit), e.g., {12, 13}, or four states (2 bits), e.g. {7, 9, 11, 13}. Other examples may be provided. In an example embodiment, the values transmitted by DCI may be applicable to some DL partial subframe durations. In an example, multiple allowable starting symbol of UpPTS may be configured. When a first LBT attempt fails, a UE may perform LBT employing a second starting symbol value.

[0225] In an example embodiment, when the DL partial subframe is larger than a value, for example for DL partial subframe size of 11 and/or 12 symbols, no partial uplink subframe may be defined. For example, the last symbol may be employed for LBT and/or reservation signals, and no uplink data, RACH and/or SRS signals may be transmitted in the subframe and uplink transmission may start from the next subframe (from beginning of symbol 0).

[0226] In an example embodiment, a pre-defined signal, for example, SRS, RACH, reference signals, and/or reservation signals may be transmitted during a partial uplink subframe. For example, SRS may be implemented for the partial uplink subframe to provide the eNB with uplink channel information.

[0227] Example embodiments may be implemented for when the last subframe of a DL burst is a full subframe. Transition from a full DL subframe n to an uplink subframe $n+1$ may be defined. Due to the required gap period, the subsequent uplink subframe $n+1$ may not be a full subframe. In an example embodiment, the size of an uplink subframe (e.g. after a full DL subframe) may be specified. Legacy TDD special subframe does not define such a configuration (a full DL subframe followed by an UL subframe). In an example, a UE may transmit PUSCH TBs in uplink subframe $n+1$.

[0228] In an example embodiment, a gap period may be specified and determined for starting uplink transmission in uplink subframe $n+1$. Gap period may impose some limitations on TA (and as a result cell radius), and/or LBT period. Pre-configuring a gap period may, for example, limit the cell radius. In an example, LAA cells may be employed for small cells and may not be expected to operate as large cells. In such a scenario, symbol 0 of uplink subframe may be employed for TA, DL_UL_switching and/or LBT period. For example, a fixed gap period of one symbol may be defined and implemented to determine a starting position in uplink subframe n . In an example, a gap period of k micro seconds may be defined to determine a starting position in uplink subframe n , wherein k is predefined, e.g. 25 usec, 50 usec, etc. In an example, uplink starting position in subframe

$n+1$ may be beginning of symbol 0 of subframe $n+1$, 25 usec from the beginning of subframe $n+1$, 25 usec+TA from the beginning of subframe $n+1$, beginning of symbol 1 of subframe $n+1$. A wireless device may perform an LBT process before the starting position to determine whether the channel is clear for uplink transmission.

[0229] In an example, multiple allowable gap periods may be configured to determine a starting position in an uplink subframe. When a first LBT attempt for a first starting position fails, a UE may perform LBT for a second starting position (second gap period). For example, a UE may perform LBT in symbol 0. The UE may be allowed to LBT in symbol 7, when LBT in symbol 0 fails. Other symbol numbers may be configured in an example, e.g. symbol 1 and 7.

[0230] In an example embodiment, a gap period for an starting position may be configured employing an RRC parameter. Such configuration may provide flexibility in configuring the gap period in an LAA cell. Different bursts may employ the same gap period to determine an starting position until RRC configuration parameter changes. For example, an RRC message may comprise configuration parameters of an LAA cell comprising one or more parameters indicating the duration of a gap period (or starting position) to determine starting position for uplink transmissions in an uplink subframe, e.g. symbol 1, zero, 25 usec, 25 usec+TA. The gap period (e.g. in terms of a number of gap symbols, or in terms of predefined starting position values) may be indicated to the UE with the RRC parameter with two states (1 bit), e.g., {1, 2}, or four states (2 bits), e.g. {1, 2, 3, 4}. Other examples may be provided. In an example, the parameter may be a common parameter and may be configured the same for UEs communicating employing the LAA cell. For example, the gap period for determining a starting position may be transmitted in a SIB message. In an example embodiment, the values configured by RRC may be applicable to some DL partial subframe durations.

[0231] In an example, multiple allowable gap periods or starting positions may be configured. When a first LBT attempt for a first starting position (first gap period) fails, a UE may perform LBT employing a second starting position (second gap period). For example, a UE may perform LBT in symbol 0. The UE may be allowed to LBT in symbol 7, when LBT in symbol 0 fails. Other symbol numbers may be configured in another example, e.g. symbol 1 and 7.

[0232] In an example embodiment, a gap period may be signalled by a common DCI or a dedicated DCI. For example, a common DCI transmitted on an LAA cell may indicate the size of the gap period. For example, a dedicated DCI transmitted on an LAA cell or the cell scheduling the LAA cell may indicate the size of the gap period (e.g. in uplink grant DCI). The DCI may be transmitted in the same and/or one or more subframes prior to the subframe including the gap period. In an example, DCI format 1C may be used, e.g. employing a predefined RNTI (e.g. the same DCI that carries the size of the partial ending DL subframe). Such configuration may provide flexibility in configuring the gap period (starting position) in an LAA cell for a given burst. Different bursts may employ different gap periods (starting positions) depending on the DCI parameter. For example, a DCI may comprise one or more parameters indicating the duration of a gap period (starting position), e.g. beginning of symbol 1, zero, 25 usec, 25 usec+TA. The gap period (e.g. in terms of a number of gap symbols, or in terms of

predefined starting position values) may be indicated to the UE with a DCI field with two states (1 bit), e.g., {1, 2}, or four states (2 bits), e.g. {1, 2, 3, 4}. Other examples may be provided. In an example embodiment, the values transmitted by DCI may be applicable to some DL partial subframe durations. In an example, multiple allowable gap periods for multiple starting positions may be configured. When a first LBT attempt fails, a UE may perform LBT employing a second gap period.

[0233] In an example embodiment, a starting symbol of subframe $n+1$ may be signalled by a common DCI or dedicated DCI. For example, a common DCI transmitted on an LAA cell may indicate a starting symbol of subframe $n+1$. For example, a dedicated DCI transmitted on an LAA cell or the cell scheduling the LAA cell may indicate the size of the gap period (e.g. in uplink grant DCI). For example, a dedicated DCI transmitted on an LAA cell or the cell scheduling the LAA cell may indicate a starting symbol of uplink subframe. In an example, a field in uplink grant DCI may indicate a value indicating a starting symbol. The DCI may be transmitted in one or more subframes prior to the subframe including the gap period for the starting position. In an example, DCI format 1C may be used, e.g. employing a predefined RNTI (e.g. the same DCI that carries the size of the ending DL subframe). Such configuration may provide flexibility in configuring the gap period for an starting position of an uplink subframe in an LAA cell for a given burst. Different bursts may employ different gap periods depending on the DCI parameter. For example, a DCI may comprise one or more parameters indicating a starting position of subframe $n+1$, e.g. beginning of symbol 1, zero, 25 usec, 25 usec+TA. A starting symbol of subframe $n+1$ (e.g. in terms of symbol number, and/or a time duration) may be indicated to the UE with a DCI field with two states (1 bit), e.g., {1, 2}, or four states (2 bits), e.g. {0, 1, 2, 3}. In an example, multiple allowable starting symbol of subframe $n+1$ may be configured. An eNB may transmit a DCI (e.g. uplink grant DCI, common DCI) comprising a plurality of starting position for an uplink subframe. When a first LBT attempt for a first starting position fails, a UE may perform LBT employing a second gap period for a second starting position. In an example, an uplink grant for subframe $n+1$ (single and/or multi-subframe grant) may include one or more parameters indicating one or more starting symbol of subframe $n+1$.

[0234] In an example embodiment, one or more gap periods, and/or one or more starting positions may be configured. For example, when LBT fails in a first allowable transmission symbol, the UE may perform a subsequent LBT for transmission on the next allowable transmission starting symbol.

[0235] The size of partial uplink subframe $n+1$, may be 14 minus a gap period. The gap period may determine a starting position for transmission in an uplink subframe. For example, when the gap period is 1, the size of the partial uplink subframe may be 13. The starting position may be the beginning of symbol 1 (the second symbol in a subframe).

[0236] In an example, gap period may be equal or larger than $(DL_UL_switch+TA+LBT_period+reservation_signal_period)$. One or more of these parameters may be zero. For example, when reservation signal is not transmitted, $reservation_signal_period$ may be considered as zero. In an example DL_UL_switch may be considered zero. In an

example, when no LBT is performed, LBT period may be zero. In another example, LBT may be, e.g. 25 microseconds, one symbol, etc.

[0237] The UE may construct one or more transport blocks for transmission in the uplink subframe. A UE may perform an LBT procedure for transmission of uplink transport blocks. The UE may transmit the transport blocks in the uplink subframe employing fields in the uplink grant, e.g. uplink radio resources (transport block), modulation and coding, RV and/or other transmission format and parameters. The UE may transmit uplink transport blocks in response to an LBT process being successfully completed (indicating a clear channel).

[0238] Upon reception of a timing advance command for a TAG containing the primary cell or PSCell, the UE may adjust uplink transmission timing for PUCCH/PUSCH/SRS of the primary cell or PSCell based on the received timing advance command.

[0239] An eNB may transmit to a wireless device a DCI comprising an uplink grant (e.g. at least one field indicating an assignment of radio resource blocks, MCS, RV, and/or the like) and/or a starting position for an uplink subframe. The DCI may comprise one or more fields indicating a start symbol and/or time for LBT procedures and/or uplink transmission. In an example, the DCI may comprise one or more parameters indicating that uplink transmission is via a partial subframe. The UE may perform 25 us LBT or Cat 4 LBT procedure before the uplink transmission. In an example, the UE may obtain channel access before the UE starts uplink transmission. In an example, a UE may have one LBT process opportunity per subframe, when one starting position is indicated by one or more DCIs and/or one or more RRC messages. In an example, when a UE cannot access the channel from a first indicated starting position due to LBT failure, the UE may drop the whole UL subframe.

[0240] Additional starting positions in an uplink subframe may enhance the efficiency of a channel access process. The channel access probability may increase when a number of starting positions and LBT procedures in an uplink subframe increases. For example, an LBT process performed by a UE may not indicate a clear channel for a first starting position (e.g., symbol 0, 25 usec, TA+25 usec, symbol 1, etc). The UE may perform LBT procedure for a second starting position and begin UL transmission when a second LBT process indicates a clear channel (e.g., a first symbol of second slot). Performing LBT in multiple UL starting positions may increase uplink channel efficiency. To benefit from additional UL starting points, a UE may start transmitting PUSCH either employing a first position or a second position of a subframe, depending on where an LBT process indicates a clear channel. In an example, second slot boundary may be employed as additional UL starting position for LBT and/or uplink transmission (e.g. symbol 0, symbol 1, 25 usec, and/or TA+25 usec of the second slot).

[0241] In an example, an eNB may transmit an RRC message comprising one or more parameters to indicate whether a UE can start performing LBT and/or transmit uplink signals from a second starting position (e.g. second slot boundary) in addition to a first starting position. In an example, the one or more parameters may indicate a plurality of allowed starting positions in an uplink subframe corresponding to an uplink grant. In an example, a UE may start a channel access procedure for UL transmission from a second position (e.g. second slot boundary, second symbol

position) in response to the UE failing to access the channel at a first starting position. A plurality of starting positions may be configured for an uplink subframe.

[0242] In an example embodiment, starting positions of UL subframe transmission may be dynamically indicated to the UE in an UL grant DCI. In an example, LBT procedure and uplink transmission starting times may be indicated by a DCI (e.g. uplink DCI grant comprising uplink grant for uplink transmission in one or more subframes). A base station may transmit one or more DCIs comprising at least one uplink grant field (uplink resource block assignment, MCS, RV, etc) and one or more fields indicating a plurality of allowed starting positions in an uplink subframe. In an example, an UL grant may indicate resource allocation with a starting position in a first or a second slot of a subframe. Depending on whether the UE clears LBT for a first starting position or a second starting position, the UE may employ the first or the second starting positions for transmission of one or more transport blocks. In an example, transmission parameters (MCS, TBS, HARQ ID, NDI, or RV etc. indicated by fields in the DCI) may be the same in both cases.

[0243] The eNB may transmit to a wireless device a DCI comprising an uplink grant for UL transmission. In response to the UE LBT not indicating a clear channel for a first starting position (e.g. at symbol 0, symbol 1, 25 usec, or TA+25 usec of a first slot), the UE may start LBT and uplink transmission for a second starting position (e.g. of a second slot).

[0244] In an example, when an LBT process for a first starting position does not indicate a clear channel, the UE may perform an LBT for a partial subframe transmission. The UE may employ rate matching and/or puncturing for transmission of one or more transport blocks in the uplink.

[0245] In an example, multiple starting positions may be configured by one or more RRC messages and/or one or more DCIs (e.g. uplink DCI grants). The eNB may transmit one or more DCIs indicating an uplink grant for a subframe. The UE may attempt transmission for a first starting position of a subframe. When the LBT process for the first starting position fails, the UE may attempt another LBT for a second starting position of the subframe and performs transmission if the second LBT is successful.

[0246] According to various embodiments, a device such as, for example, a wireless device, off-network wireless device, a base station, and/or the like, may comprise one or more processors and memory. The memory may store instructions that, when executed by the one or more processors, cause the device to perform a series of actions. Embodiments of example actions are illustrated in the accompanying figures and specification. Features from various embodiments may be combined to create yet further embodiments.

[0247] FIG. 20 is an example flow diagram as per an aspect of an embodiment of the present disclosure. A wireless device may receive one or more messages at **2010**. The Message(s) may comprise configuration parameters of a licensed assisted access (LAA) cell.

[0248] A downlink control information (DCI) for the LAA cell may be received at **2020**. According to an embodiment, the DCI may be a dedicated DCI. The DCI may comprise a at least one first field and at least one second field. The at least one first field may indicate uplink resources for an uplink subframe of the LAA cell, e.g. resource block assignment, transmission format, MCS, RV, etc. The at least one

second field may indicate a first starting position (or a gap period) in a plurality of starting positions (or gap periods) in the uplink subframe. The first starting position may be determined, at least, based on a sum of twenty-five micro-seconds plus a timing advance value. According to an embodiment, the second field may comprise two bits of information. According to an embodiment, the plurality of starting positions may comprise: a beginning of symbol zero, a beginning of symbol one, and twenty-five micro-seconds after the beginning of symbol zero.

[0249] One or more transport blocks may be constructed at **2030** employing the DCI. At **2040**, one or more transport blocks may be transmitted in the uplink resources starting from the first starting position.

[0250] According to an embodiment, the wireless device may perform a listen-before-talk (LBT) process for the twenty-five micro-seconds. According to an embodiment, the uplink subframe may start earlier than a downlink subframe by the timing advance value. According to an embodiment, the wireless device may not transmit any uplink signals on the LAA cell during a gap period before the first starting position. According to an embodiment, the wireless device may receive a full downlink subframe in a subframe preceding the uplink subframe. According to an embodiment, the wireless device may receive a partial downlink subframe in a subframe preceding the uplink subframe. According to an embodiment, the wireless device may receive a timing advance command comprising the timing advance value, and adjust uplink transmission timing for one or more uplink channels based on the timing advance value.

[0251] The UL transmission timing for PUSCH/SRS of a secondary cell is the same as the primary cell if the secondary cell and the primary cell belong to the same TAG. In an example, if the primary cell in a TAG has a frame structure type 1 and a secondary cell in the same TAG has a frame structure type 2, UE may assume that $NTA \geq 624$.

[0252] If the UE is configured with a SCG, the UL transmission timing for PUSCH/SRS of a secondary cell other than the PSCell may be the same as the PSCell if the secondary cell and the PSCell belong to the same TAG.

[0253] In an example implementation, upon reception of a timing advance command for a TAG not containing the primary cell or PSCell, if the serving cells in the TAG have the same frame structure type, the UE may adjust uplink transmission timing for PUSCH/SRS of the secondary cells in the TAG based on the received timing advance command where the UL transmission timing for PUSCH/SRS is the same for the secondary cells in the TAG.

[0254] In an example implementation, upon reception of a timing advance command for a TAG not containing the primary cell or PSCell, if a serving cell in the TAG has a different frame structure type compared to the frame structure type of another serving cell in the same TAG, the UE may adjust uplink transmission timing for PUSCH/SRS of the secondary cells in the TAG by using $NTA_{offset} = 624$ regardless of the frame structure type of the serving cells and based on the received timing advance command where the UL transmission timing for PUSCH/SRS is the same for the secondary cells in the TAG.

[0255] The timing advance command for a TAG may indicate the change of the uplink timing relative to the current uplink timing for the TAG as multiples of $16 T_s$.

[0256] In an example implementation, in case of random access response, an 11-bit timing advance command, TA, for a TAG indicates NTA values by index values of TA=0, 1, 2, . . . , 256 if the UE is configured with a SCG, and TA=0, 1, 2, . . . , 1282 otherwise, where an amount of the time alignment for the TAG is given by $NTA=TA \times 16$. In other cases, a 6-bit timing advance command, TA, for a TAG indicates adjustment of the current NTA value, NTA_{old} , to the new NTA value, NTA_{new} , by index values of TA=0, 1, 2, . . . , 63, where $NTA_{new}=NTA_{old}+(TA-31) \times 16$. Here, adjustment of NTA value by a positive or a negative amount indicates advancing or delaying the uplink transmission timing for the TAG by a given amount respectively.

[0257] For a timing advance command received on subframe n, the corresponding adjustment of the uplink transmission timing may apply from the beginning of subframe n+6. For serving cells in the same TAG, when the UE's uplink PUCCH/PUSCH/SRS transmissions in subframe n and subframe n+1 are overlapped due to the timing adjustment, the UE may complete transmission of subframe n and not transmit the overlapped part of subframe n+1.

[0258] If the received downlink timing changes and is not compensated or is only partly compensated by the uplink timing adjustment without timing advance command, the UE may change NTA accordingly.

[0259] In an example embodiment, the size of a gap period may result in a maximum allowed NTA value (e.g. in an ending DL subframe in an LAA system, and/or in a special subframe of a Licensed-cell). In an example embodiment, an eNB may transmit one or more message (e.g. RRC message) configuring a maximum NTA value. In an example, a maximum allowed NTA value may be pre-specified. For example, maximum NTA value may be 5, 10, or 15 microseconds. Other examples may be provided. UE behaviour when maximum NTA value is reached may be defined to enhance uplink performance and/or reduce interference. In legacy LTE systems, a process is implemented to trigger certain actions when the uplink transmission timing difference between the pTAG and any of the two sTAGs or between the two sTAGs of at least a maximum value, e.g. 32.47 μ s. There is no mechanism to limit the value of NTA regarding of the timing difference value. Such mechanism may be needed to increase radio link efficiency, e.g. when the cell radius is relatively large. Example embodiments may improve downlink/uplink switching and uplink transmission when frame structure 2 and/or 3 is implemented.

[0260] In an example implementation, the UE initial transmission timing error may be less than or equal to $\pm T_e$ where the timing error limit value T_e may depend on a channel bandwidth. This requirement may apply when it is the first transmission in a DRX cycle for PUCCH, PUSCH and SRS or it is the PRACH transmission. The reference point for the UE initial transmit timing control requirement may be the downlink timing of the reference cell minus $(N_{TA_Ref} + N_{TA_Offset}) \times T_s$. The downlink timing is defined as the time when the first detected path (in time) of the corresponding downlink frame is received from the reference cell. NTA_Ref for PRACH is defined as 0. $(N_{TA_Ref} + N_{TA_Offset})$ (in T_s units) for other channels is the difference between UE transmission timing and the Downlink timing immediately after when the last timing advance was applied. NTA_Ref for other channels is not changed until next timing advance is received.

[0261] When it is not the first transmission in a DRX cycle or there is no DRX cycle, and when it is the transmission for PUCCH, PUSCH and SRS transmission, the UE may be capable of changing the transmission timing according to the received downlink frame of the reference cell. The UE may be required to adjust its timing to within $\pm T_e$ in a TAG when, changing the downlink SCell for deriving the UE transmit timing for cells in the sTAG configured with one or two uplinks; in this TAG the transmission timing error between the UE and the reference timing exceeds $\pm T_e$; and/or configured with a pTAG and one or two sTAG, the transmission timing difference between TAGs does not exceed the maximum transmission timing difference (e.g., 32.47 us) after such adjustment.

[0262] If the transmission timing difference after such adjustment is bigger than the maximum transmission timing difference (e.g., 32.47 us) UE may stop adjustment in this TAG. The reference timing may be $(N_{TA_Ref} + N_{TA_Offset}) \times T_s$ before the downlink timing of the reference cell.

[0263] In an example, if NTA after such adjustment is bigger than the maximum allowed NTA, a UE may stop adjustment in this TAG. In an example, if NTA after such adjustment is bigger than the maximum allowed NTA, a UE may stop uplink transmission on one or more SCells in this TAG.

[0264] In an example embodiment, adjustments made to the UE uplink timing under the above mentioned scenarios may follow these rules: 1) The maximum amount of the magnitude of the timing change in one adjustment may be T_q seconds. 2) The minimum aggregate adjustment rate may be $7 \times T_s$ per second. 3) The maximum aggregate adjustment rate may be T_q per 200 ms.

[0265] An eNB may transmit one or more MAC TA commands including a timing advance value for a TAG. In an example embodiment, a UE may stop transmitting on one or more SCells if after timing adjusting due to a received MAC TA command, the NTA exceeds the maximum allowed NTA on a cell. Increasing NTA above the limit, may cause issues in a special subframe, or in switching from an ending DL subframe in an LAA cell to an UL subframe.

[0266] In an example embodiment, if the received downlink timing changes and is not compensated or is partly compensated by the uplink timing adjustment without timing advance command, the UE may change NTA accordingly (if NTA does not increase the maximum allowed NTA value). A UE may stop transmitting on one or more cells if after such timing adjusting, the NTA exceeds the maximum allowed NTA on a cell.

[0267] An eNB may transmit one or more MAC TA commands including a timing advance value for a TAG. In an example embodiment, a UE may not adjust uplink timing to more than maximum allowed NTA if after timing adjusting due to a received MAC TA command, the NTA exceeds the maximum allowed NTA on a cell. Increasing NTA above the limit, may cause issues in a special subframe, or in switching from an ending DL subframe in an LAA cell to an UL subframe.

[0268] In an example embodiment, if the received downlink timing changes and is not compensated or is partly compensated by the uplink timing adjustment without timing advance command, the UE may change NTA accordingly (if NTA does not increase the maximum allowed NTA value). In an example, if the received downlink timing changes and is not compensated or is partly compensated by

the uplink timing adjustment without timing advance command, the UE may not change NTA when NTA exceeds the maximum allowed NTA value.

[0269] In an example embodiment, when NTA exceeds the maximum allowed NTA value a UE may trigger certain actions at PHY, MAC, and/or RRC layer. For example, a UE may not increase NTA (autonomously or due to receipt of a MAC CE) beyond the maximum allowed NTA value. For example, a UE may stop transmission of uplink signals on one or more cells in a TAG when NTA increases (autonomously or due to receipt of a MAC CE) beyond the maximum allowed NTA value. In an example, a UE may transmit a MAC or RRC message to the eNB indicating the issue and/or a cause for the issue. For example, the UE may transmit an RRC comprising a parameter indicating that NTA exceeded the maximum allowed value. In an implementation, the eNB may deactivate one or more SCells to resolve the issue. In an implementation, the eNB may transmit one or more messages changing a maximum NTA value for one or more cells. For example, an RRC message may reconfigure the cell with different X values, gap values, and/or special subframe configuration.

[0270] In this specification, “a” and “an” and similar phrases are to be interpreted as “at least one” and “one or more.” In this specification, the term “may” is to be interpreted as “may, for example.” In other words, the term “may” is indicative that the phrase following the term “may” is an example of one of a multitude of suitable possibilities that may, or may not, be employed to one or more of the various embodiments. If A and B are sets and every element of A is also an element of B, A is called a subset of B. In this specification, only non-empty sets and subsets are considered. For example, possible subsets of $B = \{\text{cell1}, \text{cell2}\}$ are: $\{\text{cell1}\}$, $\{\text{cell2}\}$, and $\{\text{cell1}, \text{cell2}\}$.

[0271] In this specification, parameters (Information elements: IEs) may comprise one or more objects, and each of those objects may comprise one or more other objects. For example, if parameter (IE) N comprises parameter (IE) M, and parameter (IE) M comprises parameter (IE) K, and parameter (IE) K comprises parameter (information element) J, then, for example, N comprises K, and N comprises J. In an example embodiment, when one or more messages comprise a plurality of parameters, it implies that a parameter in the plurality of parameters is in at least one of the one or more messages, but does not have to be in each of the one or more messages.

[0272] Many of the elements described in the disclosed embodiments may be implemented as modules. A module is defined here as an isolatable element that performs a defined function and has a defined interface to other elements. The modules described in this disclosure may be implemented in hardware, software in combination with hardware, firmware, wetware (i.e hardware with a biological element) or a combination thereof, all of which are behaviorally equivalent. For example, modules may be implemented as a software routine written in a computer language configured to be executed by a hardware machine (such as C, C++, Fortran, Java, Basic, Matlab or the like) or a modeling/simulation program such as Simulink, Stateflow, GNU Octave, or LabVIEWMathScript. Additionally, it may be possible to implement modules using physical hardware that incorporates discrete or programmable analog, digital and/or quantum hardware. Examples of programmable hardware comprise: computers, microcontrollers, microprocessors,

application-specific integrated circuits (ASICs); field programmable gate arrays (FPGAs); and complex programmable logic devices (CPLDs). Computers, microcontrollers and microprocessors are programmed using languages such as assembly, C, C++ or the like. FPGAs, ASICs and CPLDs are often programmed using hardware description languages (HDL) such as VHSIC hardware description language (VHDL) or Verilog that configure connections between internal hardware modules with lesser functionality on a programmable device. Finally, it needs to be emphasized that the above mentioned technologies are often used in combination to achieve the result of a functional module.

[0273] The disclosure of this patent document incorporates material which is subject to copyright protection. The copyright owner has no objection to the facsimile reproduction by anyone of the patent document or the patent disclosure, as it appears in the Patent and Trademark Office patent file or records, for the limited purposes required by law, but otherwise reserves all copyright rights whatsoever.

[0274] While various embodiments have been described above, it should be understood that they have been presented by way of example, and not limitation. It will be apparent to persons skilled in the relevant art(s) that various changes in form and detail can be made therein without departing from the spirit and scope. In fact, after reading the above description, it will be apparent to one skilled in the relevant art(s) how to implement alternative embodiments. Thus, the present embodiments should not be limited by any of the above described exemplary embodiments. In particular, it should be noted that, for example purposes, the above explanation has focused on the example(s) using LAA communication systems. However, one skilled in the art will recognize that embodiments of the disclosure may also be implemented in a system comprising one or more TDD cells (e.g. frame structure 2 and/or frame structure 1). The disclosed methods and systems may be implemented in wireless or wireline systems. The features of various embodiments presented in this disclosure may be combined. One or many features (method or system) of one embodiment may be implemented in other embodiments. Only a limited number of example combinations are shown to indicate to one skilled in the art the possibility of features that may be combined in various embodiments to create enhanced transmission and reception systems and methods.

[0275] In addition, it should be understood that any figures which highlight the functionality and advantages, are presented for example purposes only. The disclosed architecture is sufficiently flexible and configurable, such that it may be utilized in ways other than that shown. For example, the actions listed in any flowchart may be re-ordered or only optionally used in some embodiments.

[0276] Further, the purpose of the Abstract of the Disclosure is to enable the U.S. Patent and Trademark Office and the public generally, and especially the scientists, engineers and practitioners in the art who are not familiar with patent or legal terms or phraseology, to determine quickly from a cursory inspection the nature and essence of the technical disclosure of the application. The Abstract of the Disclosure is not intended to be limiting as to the scope in any way.

[0277] Finally, it is the applicant’s intent that only claims that include the express language “means for” or “step for” be interpreted under 35 U.S.C. 112. Claims that do not expressly include the phrase “means for” or “step for” are not to be interpreted under 35 U.S.C. 112.

What is claimed is:

- 1. A method comprising:
 - receiving, by a wireless device, one or more messages comprising configuration parameters of a licensed assisted access (LAA) cell;
 - receiving a downlink control information (DCI) for the LAA cell, the DCI comprising:
 - a first field indicating uplink resources for an uplink subframe of the LAA cell; and
 - a second field indicating a first starting position in a plurality of starting positions in the uplink subframe, wherein the first starting position in the uplink subframe is determined, at least, based on a sum of twenty-five micro-seconds plus a timing advance value;
 - constructing one or more transport blocks employing the DCI; and
 - transmitting, by the wireless device, the one or more transport blocks in the uplink resources starting from the first starting position of the uplink subframe.
- 2. The method of claim 1, wherein the second field comprises two bits of information.
- 3. The method of claim 1, further comprising, performing, by the wireless device, a listen-before-talk (LBT) process for the twenty-five micro-seconds.
- 4. The method of claim 1, wherein the plurality of starting positions comprises:
 - a beginning of symbol zero;
 - a beginning of symbol one; and
 - twenty-five micro-seconds after the beginning of symbol zero.
- 5. The method of claim 1, wherein the uplink subframe starts earlier than a downlink subframe by the timing advance value.
- 6. The method of claim 1, wherein the wireless device does not transmit any uplink signals on the LAA cell during a gap period before the first starting position.
- 7. The method of claim 1, further comprising receiving, by the wireless device, a full downlink subframe in a subframe proceeding the uplink subframe.
- 8. The method of claim 1, further comprising receiving, by the wireless device, a partial downlink subframe in a subframe proceeding the uplink subframe.
- 9. The method of claim 1, wherein the DCI is a dedicated DCI.
- 10. The method of claim 1, further comprising:
 - receiving, by the wireless device, a timing advance command comprising the timing advance value; and
 - adjusting uplink transmission timing for one or more uplink channels based on the timing advance value.
- 11. A wireless device comprising:
 - one or more processors; and
 - memory storing instructions that, when executed by the one or more processors, cause the wireless device to:

- receive one or more messages comprising configuration parameters of a licensed assisted access (LAA) cell;
 - receive a downlink control information (DCI) for the LAA cell, the DCI comprising:
 - a first field indicating uplink resources for an uplink subframe of the LAA cell; and
 - a second field indicating a first starting position in a plurality of starting positions in the uplink subframe, wherein the first starting position in the uplink subframe is determined, at least, based on a sum of twenty-five micro-seconds plus a timing advance value;
 - construct one or more transport blocks employing the DCI; and
 - transmit the one or more transport blocks in the uplink resources starting from the first starting position of the uplink subframe.
 - 12. The wireless device of claim 11, wherein the second field comprises two bits of information.
 - 13. The wireless device of claim 11, wherein the instructions, when executed by the one or more processors, further cause the wireless device to perform a listen-before-talk (LBT) process for the twenty-five micro-seconds.
 - 14. The wireless device of claim 11, wherein the plurality of starting positions comprises:
 - a beginning of symbol zero;
 - a beginning of symbol one; and
 - twenty-five micro-seconds after the beginning of symbol zero.
 - 15. The wireless device of claim 11, wherein the uplink subframe starts earlier than a downlink subframe by the timing advance value.
 - 16. The wireless device of claim 11, wherein the wireless device does not transmit any uplink signals on the LAA cell during a gap period before the first starting position.
 - 17. The wireless device of claim 11, wherein the instructions, when executed by the one or more processors, further cause the wireless device to receive a full downlink subframe in a subframe proceeding the uplink subframe.
 - 18. The wireless device of claim 11, wherein the instructions, when executed by the one or more processors, further cause the wireless device to receive a partial downlink subframe in a subframe proceeding the uplink subframe.
 - 19. The wireless device of claim 11, wherein the DCI is a dedicated DCI.
 - 20. The wireless device of claim 11, wherein the instructions, when executed by the one or more processors, further cause the wireless device to:
 - receive a timing advance command comprising the timing advance value; and
 - adjust uplink transmission timing for one or more uplink channels based on the timing advance value.

* * * * *